

DM74LS273 8-Bit Register with Clear

General Description

The DM74LS273 is a high speed 8-bit register, consisting of eight D-type flip-flops with a common Clock and an asynchronous active LOW Master Reset. This device is supplied in a 20-pin package featuring 0.3 inch row spacing.

Features

- Edge-triggered
- 8-bit high speed register
- Parallel in and out
- Common clock and master reset

Ordering Code:

Order Number	Package Number	Package Description
DM74LS273WM	M20B	20-Lead Small Outline Integrated Circuit (SOIC), JEDEC MS-013, 0.300 Wide
DM74LS273SJ	M20D	20-Lead Small Outline Package (SOP), EIAJ TYPE II, 5.3mm Wide
DM74LS273N	N20A	20-Lead Plastic Dual-In-Line Package (PDIP), JEDEC MS-001, 0.300 Wide

Devices also available in Tape and Reel. Specify by appending the suffix letter "X" to the ordering code.

Logic Symbol

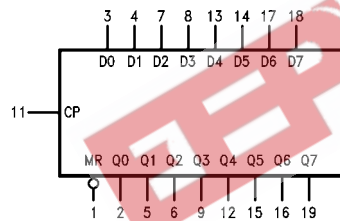

V_{CC} = Pin 20
GND = Pin 10

Connection Diagram

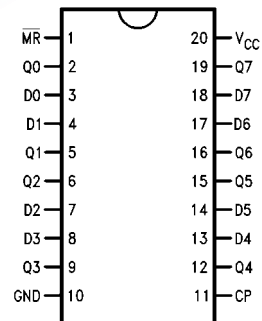

Pin Descriptions

Pin Names	Description
CP	Clock Pulse Input (Active Rising Edge)
D0–D7	Data Inputs
$\overline{\text{MR}}$	Asynchronous Master Reset Input (Active LOW)
Q0–Q7	Flip-Flop Outputs

Truth Table

MR	Inputs		Outputs
	CP	D _n	
L	X	X	L
H	↗	H	H
H	↘	L	L

H = HIGH Voltage Level
L = LOW Voltage Level
X = Immaterial

Functional Description

The DM74LS273 is an 8-bit parallel register with a common Clock and common Master Reset. When the \overline{MR} input is LOW, the Q outputs are LOW, independent of the other inputs. Information meeting the setup and hold time requirements of the D inputs is transferred to the Q outputs on the LOW-to-HIGH transition of the clock input.

Logic Diagram

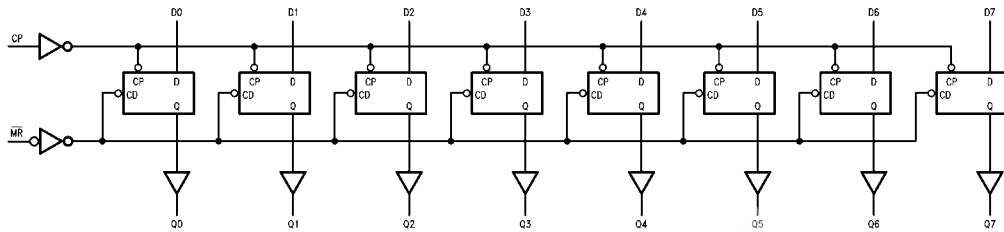

EEPW.com.cn 电子产品世界

Absolute Maximum Ratings(Note 1)

Supply Voltage	7V
Input Voltage	7V
Operating Free Air Temperature Range	0°C to +70°C
Storage Temperature Range	-65°C to +150°C

Note 1: The "Absolute Maximum Ratings" are those values beyond which the safety of the device cannot be guaranteed. The device should not be operated at these limits. The parametric values defined in the Electrical Characteristics tables are not guaranteed at the absolute maximum ratings. The "Recommended Operating Conditions" table will define the conditions for actual device operation.

Recommended Operating Conditions

Symbol	Parameter	Min	Nom	Max	Units
V _{CC}	Supply Voltage	4.75	5	5.25	V
V _{IH}	HIGH Level Input Voltage	2			V
V _{IL}	LOW Level Input Voltage			0.8	V
I _{OH}	HIGH Level Output Current			-0.4	mA
I _{OL}	LOW Level Output Current			8	mA
T _A	Free Air Operating Temperature	0		70	°C
t _S (H)	Setup Time HIGH or LOW	15			ns
t _S (L)	D _n to CP	15			ns
t _H (H)	Hold Time HIGH or LOW	5			ns
t _H (L)	D _n to CP	5			ns
t _W (H)	CP Pulse Width HIGH or LOW	20			ns
t _W (L)		20			ns
t _W (L)	MR Pulse Width LOW	20			ns
t _{REC}	Recovery Time MR to CP	15			ns

Electrical Characteristics

Over recommended operating free air temperature range (unless otherwise noted)

Symbol	Parameter	Conditions	Min	Typ (Note 2)	Max	Units
V _I	Input Clamp Voltage	V _{CC} = Min, I _I = -18 mA			-1.5	V
V _{OH}	HIGH Level Output Voltage	V _{CC} = Min, I _{OH} = Max, V _{IL} = Max	2.7	3.4		V
V _{OL}	LOW Level Output Voltage	V _{CC} = Min, I _{OL} = Max, V _{IH} = Min		0.35	0.5	V
I _I	Input Current @ Max Input Voltage	I _{OL} = 4 mA, V _{CC} = Min		0.25	0.4	mA
I _{IH}	HIGH Level Input Current	V _{CC} = Max, V _I = 2.7V			20	μA
I _{IL}	LOW Level Input Current	V _{CC} = Max, V _I = 0.4V			-0.4	mA
I _{OS}	Short Circuit Output Current	V _{CC} = Max (Note 3)	-20		-100	mA
I _{CC}	Supply Current	V _{CC} = Max			27	mA

Note 2: All typicals are at V_{CC} = 5V, T_A = 25°C.

Note 3: Not more than one output should be shorted at a time, and the duration should not exceed one second.

Switching Characteristics

V_{CC} = +5.0V, T_A = +25°C

Symbol	Parameter	C _L = 15 pF		Units
		R _L = 2 kΩ		
		Min	Max	
f _{MAX}	Maximum Clock Frequency	30		MHz
t _{PLH}	Propagation Delay CP to Q _n		24	ns
t _{PHL}	Propagation Delay MR to Q _n		24	ns
t _{PLH}	Propagation Delay MR to Q _n		27	ns

Physical Dimensions inches (millimeters) unless otherwise noted

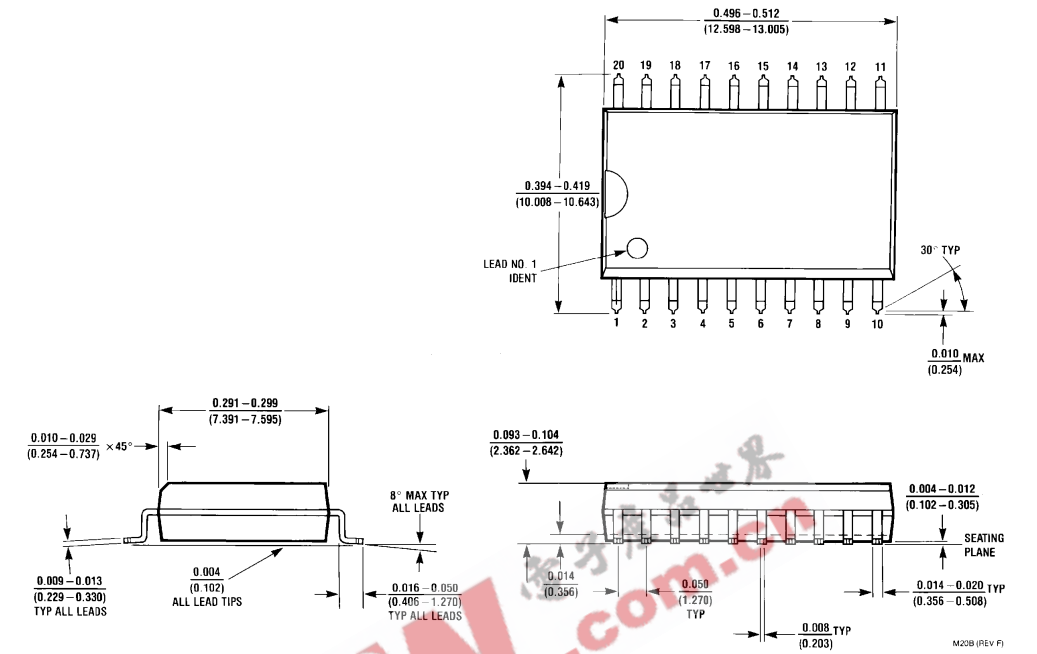

**20-Lead Small Outline Integrated Circuit (SOIC), JEDEC MS-013, 0.300 Wide
Package Number M20B**

Physical Dimensions inches (millimeters) unless otherwise noted (Continued)

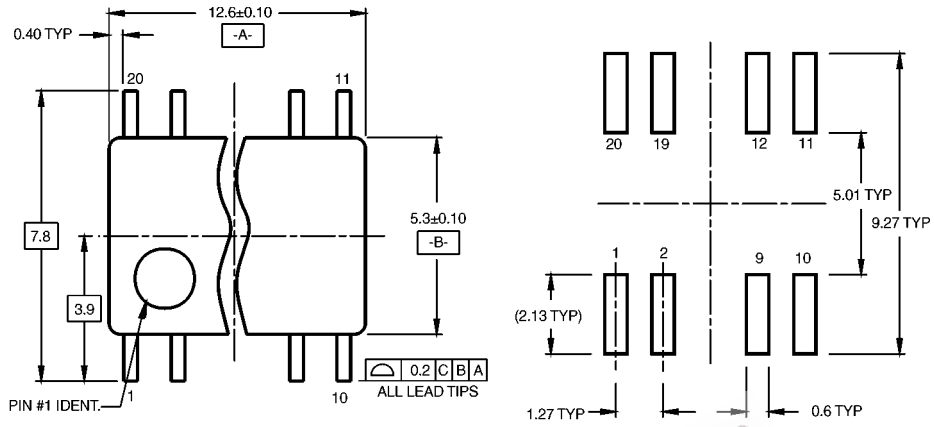

LAND PATTERN RECOMMENDATION

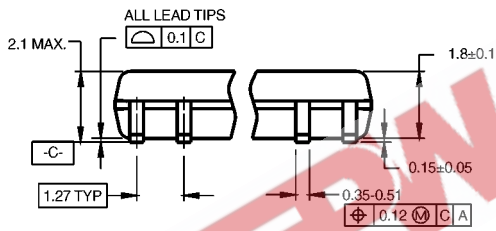

DIMENSIONS ARE IN MILLIMETERS

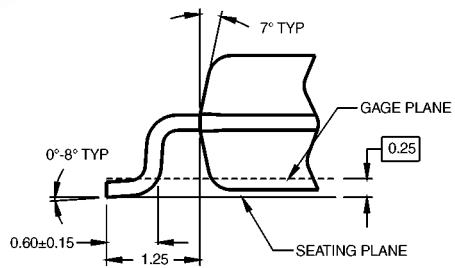
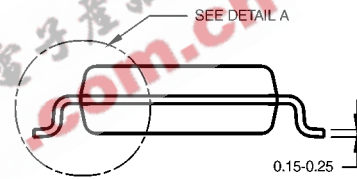

DETAIL A

- NOTES:
- A. CONFORMS TO EIAJ EDR-7320 REGISTRATION, ESTABLISHED IN DECEMBER, 1998.
 - B. DIMENSIONS ARE IN MILLIMETERS.
 - C. DIMENSIONS ARE EXCLUSIVE OF BURRS, MOLD FLASH, AND TIE BAR EXTRUSIONS.

M20DRevB1

20-Lead Small Outline Package (SOP), EIAJ TYPE II, 5.3mm Wide Package Number M20D

Physical Dimensions inches (millimeters) unless otherwise noted (Continued)

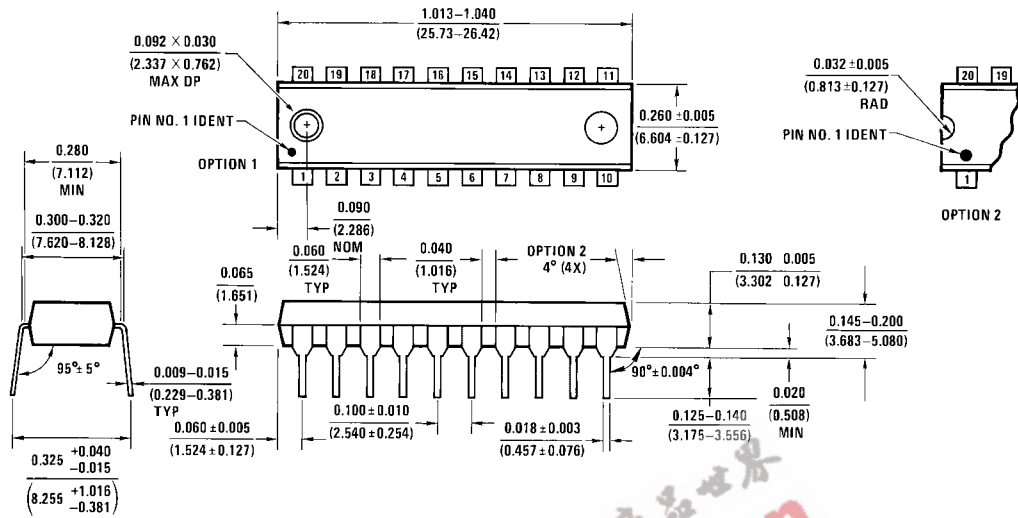

20-Lead Plastic Dual-In-Line Package (PDIP), JEDEC MS-001, 0.300 Wide
Package Number N20A

Fairchild does not assume any responsibility for use of any circuitry described, no circuit patent licenses are implied and Fairchild reserves the right at any time without notice to change said circuitry and specifications.

LIFE SUPPORT POLICY

FAIRCHILD'S PRODUCTS ARE NOT AUTHORIZED FOR USE AS CRITICAL COMPONENTS IN LIFE SUPPORT DEVICES OR SYSTEMS WITHOUT THE EXPRESS WRITTEN APPROVAL OF THE PRESIDENT OF FAIRCHILD SEMICONDUCTOR CORPORATION. As used herein:

1. Life support devices or systems are devices or systems which, (a) are intended for surgical implant into the body, or (b) support or sustain life, and (c) whose failure to perform when properly used in accordance with instructions for use provided in the labeling, can be reasonably expected to result in a significant injury to the user.
2. A critical component in any component of a life support device or system whose failure to perform can be reasonably expected to cause the failure of the life support device or system, or to affect its safety or effectiveness.

www.fairchildsemi.com