

54F/74F164A Serial-In, Parallel-Out Shift Register

General Description

The 'F164A is a high-speed 8-bit serial-in/parallel-out shift register. Serial data is entered through a 2-input AND gate synchronous with the LOW-to-HIGH transition of the clock. The device features an asynchronous Master Reset which clears the register, setting all outputs LOW independent of the clock. The 'F164A is a faster version of the 'F164.

Features

- Typical shift frequency of 90 MHz
- Asynchronous Master Reset
- Gated serial data input
- Fully synchronous data transfers
- Guaranteed 4000V min ESD protection
- 'F164A is a faster version of the 'F164

Commercial	Military	Package Number	Package Description
74F164APC		N14A	14-Lead (0.300" Wide) Molded Dual-In-Line
	54F164ADM (Note 2)	J14A	14-Lead Ceramic Dual-In-Line
74F164ASC (Note 1)		M14A	14-Lead (0.150" Wide) Molded Small Outline, JEDEC
74F164ASJ (Note 1)		M14D	14-Lead (0.300" Wide) Molded Small Outline, EIAJ
	74F164AFM (Note 2)	W14B	14-Lead Cerpack
	74F164ALM (Note 2)	E20A	20-Lead Ceramic Leadless Chip Carrier, Type C

Note 1: Devices also available in 13" reel. Use suffix = SCX and SJX.

Note 2: Military grade device with environmental and burn-in processing. Use suffix = DMQB, FMQB and LMQB.

Logic Symbols

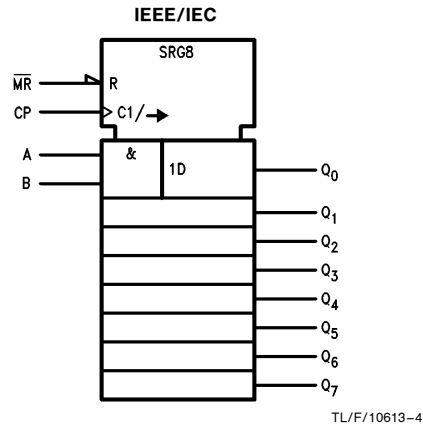
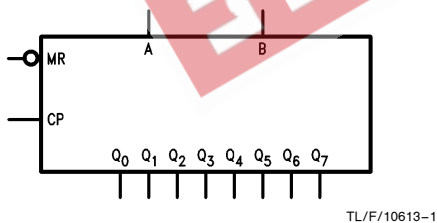

TRI-STATE® is a registered trademark of National Semiconductor Corporation.

Connection Diagrams

Pin Assignment for DIP, SOIC and Flatpak

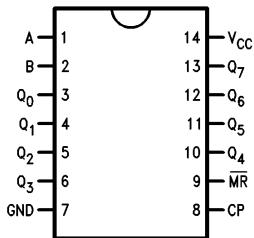

TL/F/10613-2

Pin Assignment for LCC

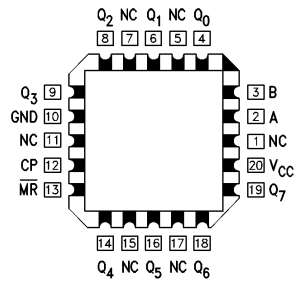

TL/F/10613-3

Unit Loading/Fan Out

Pin Names	Description	54F/74F	
		U.L. HIGH/LOW	Input I _{IH} /I _{IL} Output I _{OH} /I _{OL}
A, B	Data Inputs	1.0/1.0	20 μA/ -0.6 mA
CP	Clock Pulse Input (Active Rising Edge)	1.0/1.0	20 μA/ -0.6 mA
MR	Master Reset Input (Active LOW)	1.0/1.0	20 μA/ -0.6 mA
Q ₀ -Q ₇	Outputs	50/33.3	-1 mA/20 mA

Functional Description

The 'F164A is an edge-triggered 8-bit shift register with serial data entry and an output from each of the eight stages. Data is entered serially through one of two inputs (A or B); either of these inputs can be used as an active HIGH Enable for data entry through the other input. An unused input must be tied HIGH.

Each LOW-to-HIGH transition on the Clock (CP) input shifts data one place to the right and enters into Q₀ the logical AND of the two data inputs (A • B) that existed before the rising clock edge. A LOW level on the Master Reset (MR) input overrides all other inputs and clears the register asynchronously, forcing all Q outputs LOW.

Mode Select Table

Operating Mode	Inputs			Outputs	
	MR	A	B	Q ₀	Q ₁ -Q ₇
Reset (Clear)	L	X	X	L	L-L
Shift	H	l	l	L	Q ₀ -Q ₆
	H	l	h	L	Q ₀ -Q ₆
	H	h	l	L	Q ₀ -Q ₆
	H	h	h	H	Q ₀ -Q ₆

H(h) = HIGH Voltage Levels

L(l) = LOW Voltage Levels

X = Immaterial

Q_n = Lower case letters indicate the state of the referenced input or output one setup time prior to the LOW-to-HIGH clock transition.

Logic Diagram

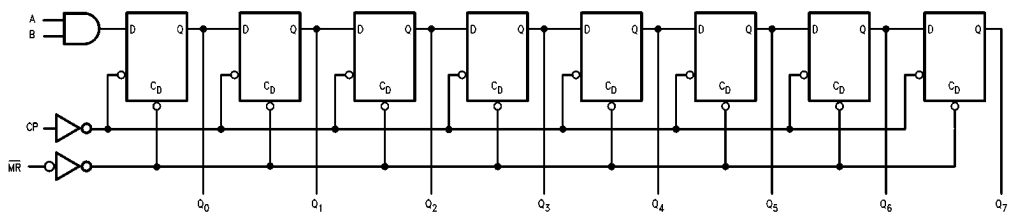

TL/F/10613-5

Please note that this diagram is provided only for the understanding of logic operations and should not be used to estimate propagation delays.

Absolute Maximum Ratings (Note 1)

If Military/Aerospace specified devices are required, please contact the National Semiconductor Sales Office/Distributors for availability and specifications.

Storage Temperature	-65°C to +150°C
Ambient Temperature under Bias	-55°C to +125°C
Junction Temperature under Bias	-55°C to +175°C
Plastic	-55°C to +150°C
V _{CC} Pin Potential to Ground Pin	-0.5V to +7.0V
Input Voltage (Note 2)	-0.5V to +7.0V
Input Current (Note 2)	-30 mA to +5.0 mA
Voltage Applied to Output in HIGH State (with V _{CC} = 0V)	
Standard Output	-0.5V to V _{CC}
TRI-STATE® Output	-0.5V to +5.5V

Current Applied to Output in LOW State (Max) twice the rated I_{OL} (mA)

ESD Last Passing Voltage (Min) 4000V

Note 1: Absolute maximum ratings are values beyond which the device may be damaged or have its useful life impaired. Functional operation under these conditions is not implied.

Note 2: Either voltage limit or current limit is sufficient to protect inputs.

Recommended Operating Conditions

Free Air Ambient Temperature	
Military	-55°C to +125°C
Commercial	0°C to +70°C
Supply Voltage	
Military	+4.5V to +5.5V
Commercial	+4.5V to +5.5V

DC Electrical Characteristics

Symbol	Parameter	54F/74F			Units	V _{CC}	Conditions
		Min	Typ	Max			
V _{IH}	Input HIGH Voltage	2.0			V		Recognized as a HIGH Signal
V _{IL}	Input LOW Voltage			0.8	V		Recognized as a LOW Signal
V _{CD}	Input Clamp Diode Voltage			-1.2	V	Min	I _{IN} = -18 mA
V _{OH}	Output HIGH Voltage	54F 10% V _{CC} 74F 10% V _{CC} 74F 5% V _{CC}	2.5 2.5 2.7		V	Min	I _{OH} = -1 mA I _{OH} = -1 mA I _{OH} = -1 mA
V _{OL}	Output LOW Voltage	54F 10% V _{CC} 74F 10% V _{CC}		0.5 0.5	V	Min	I _{OL} = 20 mA I _{OL} = 20 mA
I _{IH}	Input HIGH Current	54F 74F		20.0 5.0	μA	Max	V _{IN} = 2.7V
I _{BVI}	Input HIGH Current Breakdown Test	54F 74F		100 7.0	μA	Max	V _{IN} = 7.0V
I _{CEx}	Output HIGH Leakage Current	54F 74F		250 50	μA	Max	V _{OUT} = V _{CC}
V _{ID}	Input Leakage Test	74F	4.75		V	0.0	I _{ID} = 1.9 μA All other pins grounded
I _{OD}	Output Leakage Circuit Current	74F		3.75	μA	0.0	V _{IOD} = 150 mV All other pins grounded
I _{IL}	Input LOW Current			-0.6	mA	Max	V _{IN} = 0.5V
I _{OS}	Output Short-Circuit Current		-60	-150	mA	Max	V _{OUT} = 0V
I _{CC}	Power Supply Current		35	55	mA	Max	CP = HIGH MR = GND, A, B = GND

AC Electrical Characteristics

Symbol	Parameter	74F			54F		74F		Units
		T _A = +25°C V _{CC} = +5.0V C _L = 50 pF			T _A , V _{CC} = Mil C _L = 50 pF		T _A , V _{CC} = Com C _L = 50 pF		
		Min	Typ	Max	Min	Max	Min	Max	
f _{max}	Maximum Clock Frequency	80	120		60	90	80		MHz
t _{PLH}	Propagation Delay CP to Q _n	3.0	4.8	7.5	2.5	9.0	3.0	7.5	ns
t _{PHL}	Propagation Delay MR to Q _n	3.5	5.0	8.0	3.0	8.5	3.5	8.0	
t _{PHL}	Propagation Delay MR to Q _n	5.0	7.0	10.0	4.0	12.5	5.0	10.5	ns

AC Operating Requirements

Symbol	Parameter	74F		54F		74F		Units
		T _A = +25°C V _{CC} = +5.0V		T _A , V _{CC} = Mil		T _A , V _{CC} = Com		
		Min	Max	Min	Max	Min	Max	
t _s (H)	Setup Time, HIGH or LOW	4.5		5.5		4.5		ns
t _s (L)	A or B to CP	4.0		4.0		4.0		
t _h (H)	Hold Time, HIGH or LOW	1.0		1.0		1.0		ns
t _h (L)	A or B to CP	1.0		1.0		1.0		
t _w (H)	CP Pulse Width	4.0		4.0		4.0		ns
t _w (L)	HIGH or LOW	7.0		7.0		7.0		
t _w (L)	MR Pulse Width, LOW	4.0		5.0		4.0		ns
t _{rec}	Recovery Time MR to CP	5.0		6.5		5.0		ns

Ordering Information

The device number is used to form part of a simplified purchasing code where the package type and temperature range are defined as follows:

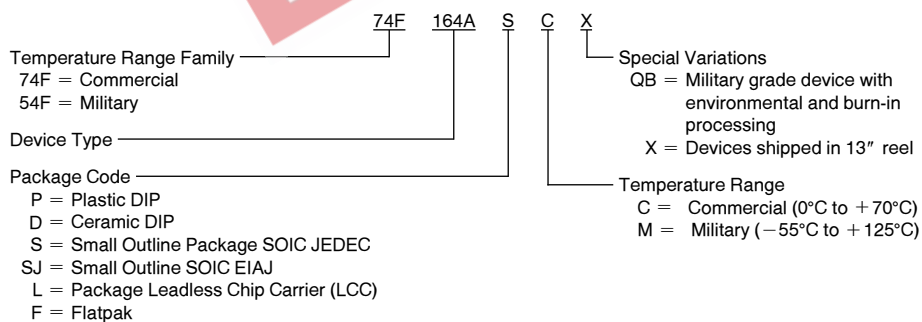

Physical Dimensions inches (millimeters)

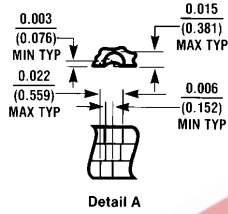
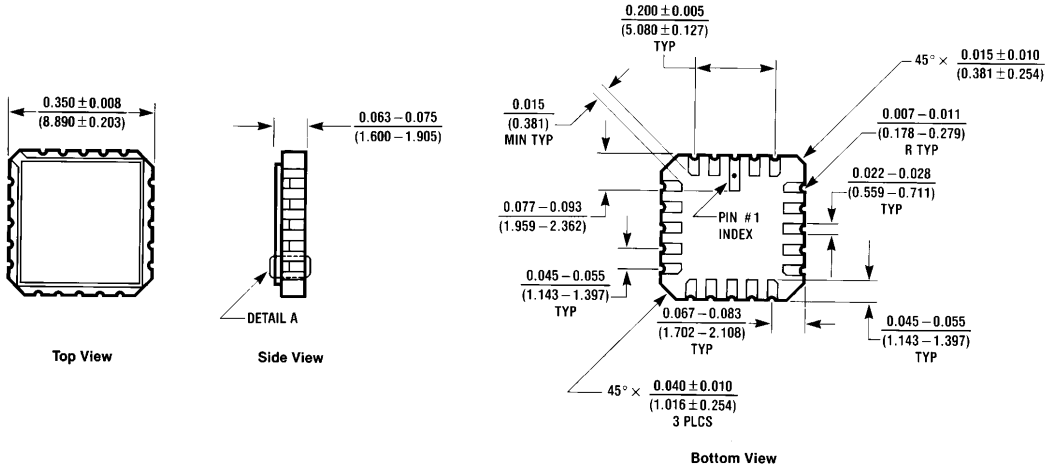

20-Lead Ceramic Leadless Chip Carrier, Type C (L)
NS Package Number E20A

E20A (REV D)

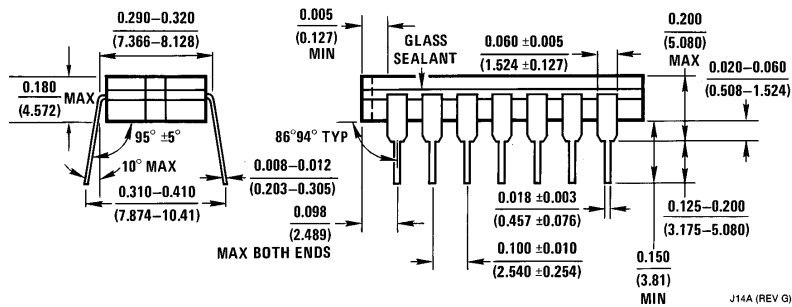
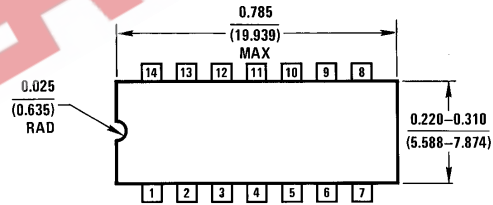

14-Lead Ceramic Dual-In-Line Package (D)
NS Package Number J14A

J14A (REV G)

Physical Dimensions inches (millimeters) (Continued)

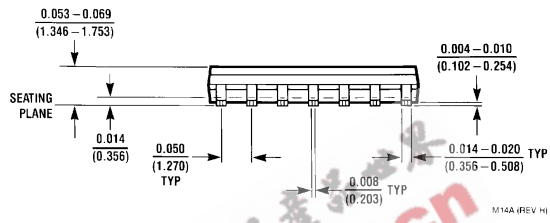
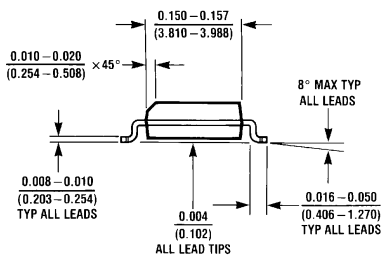
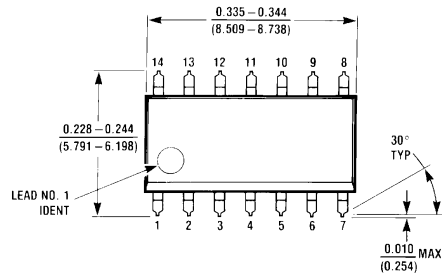

14-Lead (0.150" Wide) Molded Small Outline Package, JEDEC (S)
NS Package Number M14A

M14A (REV. H)

EEPW.com.cn

Physical Dimensions inches (millimeters) (Continued)

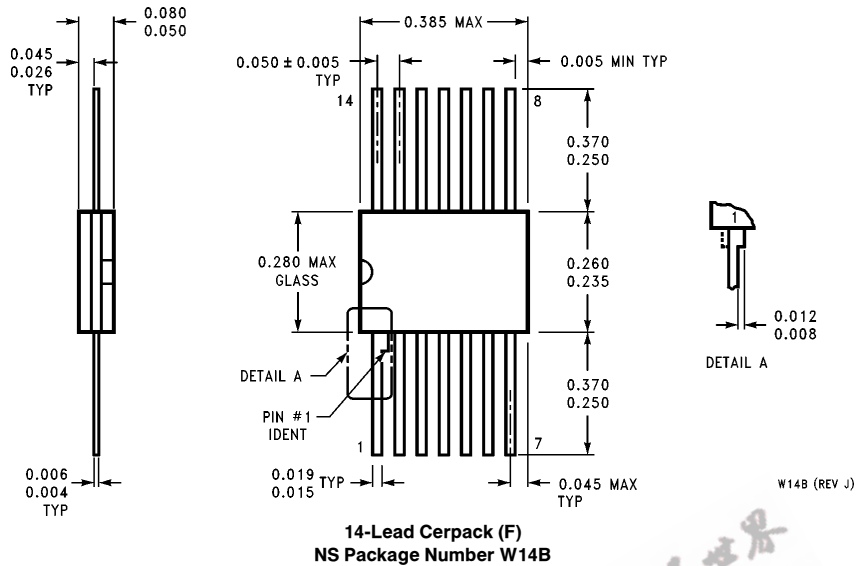

LIFE SUPPORT POLICY

NATIONAL'S PRODUCTS ARE NOT AUTHORIZED FOR USE AS CRITICAL COMPONENTS IN LIFE SUPPORT DEVICES OR SYSTEMS WITHOUT THE EXPRESS WRITTEN APPROVAL OF THE PRESIDENT OF NATIONAL SEMICONDUCTOR CORPORATION. As used herein:

1. Life support devices or systems are devices or systems which, (a) are intended for surgical implant into the body, or (b) support or sustain life, and whose failure to perform, when properly used in accordance with instructions for use provided in the labeling, can be reasonably expected to result in a significant injury to the user.
2. A critical component is any component of a life support device or system whose failure to perform can be reasonably expected to cause the failure of the life support device or system, or to affect its safety or effectiveness.



National Semiconductor Corporation
2900 Semiconductor Drive
P.O. Box 58090
Santa Clara, CA 95052-8090
Tel: 1 (800) 272-9959
TWX: (910) 339-9240

National Semiconductor GmbH
Livry-Gargan-Str. 10
D-82256 Fürstfeldbruck
Germany
Tel: (81-41) 35-0
Telex: 527649
Fax: (81-41) 35-1

National Semiconductor Japan Ltd.
Sumitomo Chemical
Engineering Center
Bldg. 7F
1-7-1, Nakase, Mihama-Ku
Chiba-City,
Chiba Prefecture 261
Tel: (043) 299-2300
Fax: (043) 299-2500

National Semiconductor Hong Kong Ltd.
13th Floor, Straight Block,
Ocean Centre, 5 Canton Rd.
Tsimshatsui, Kowloon
Hong Kong
Tel: (852) 2737-1600
Fax: (852) 2736-9960

National Semiconductores Do Brazil Ltda.
Rue Deputado Lacorda Franco
120-3A
Sao Paulo-SP
Brazil 05418-000
Tel: (55-11) 212-5066
Telex: 391-1131931 NSBR BR
Fax: (55-11) 212-1181

National Semiconductor (Australia) Pty, Ltd.
Building 16
Business Park Drive
Monash Business Park
Nottingham, Melbourne
Victoria 3168 Australia
Tel: (3) 558-9889
Fax: (3) 558-9898