

74F543 Octal Registered Transceiver

General Description

The F543 octal transceiver contains two sets of D-type latches for temporary storage of data flowing in either direction. Separate Latch Enable and Output Enable inputs are provided for each register to permit independent control of inputting and outputting in either direction of data flow. The A outputs are guaranteed to sink 24 mA while the B outputs are rated for 64 mA.

Features

- 8-bit octal transceiver
- Back-to-back registers for storage
- Separate controls for data flow in each direction
- A outputs sink 24 mA
- B outputs sink 64 mA

Ordering Code:

Order Number	Package Number	Package Description
74F543SC	M24B	24-Lead Small Outline Integrated Circuit (SOIC), JEDEC MS-013, 0.300 Wide
74F543MSA	MSA24	24-Lead Shrink Small Outline Package (SSOP), EIAJ TYPE II, 5.3mm Wide
74F543PC	N24A	24-Lead Plastic Dual-In-Line Package (PDIP), JEDEC MS-011, 0.600 Wide
74F543SPC	N24C	24-Lead Plastic Dual-In-Line Package (PDIP), JEDEC MS-001, 0.300 Wide

Devices also available in Tape and Reel. Specify by appending the suffix letter "X" to the ordering code.

Logic Symbols

Connection Diagram

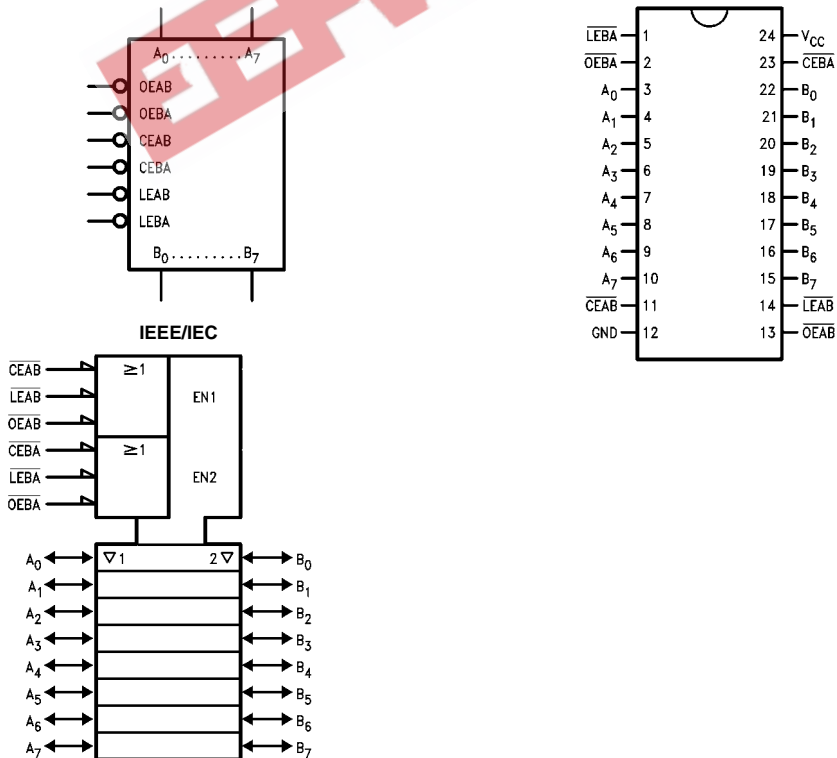

Unit Loading/Fan Out

Pin Names	Description	U.L.	
		HIGH/LOW	Input I_{IH}/I_{IL} Output I_{OH}/I_{OL}
\overline{OEAB}	A-to-B Output Enable Input (Active LOW)	1.0/1.0	20 μ A/-0.6 mA
\overline{OEBA}	B-to-A Output Enable Input (Active LOW)	1.0/1.0	20 μ A/-0.6 mA
\overline{CEAB}	A-to-B Enable Input (Active LOW)	1.0/2.0	20 μ A/-1.2 mA
\overline{CEBA}	B-to-A Enable Input (Active LOW)	1.0/2.0	20 μ A/-1.2 mA
\overline{LEAB}	A-to-B Latch Enable Input (Active LOW)	1.0/1.0	20 μ A/-0.6 mA
\overline{LEBA}	B-to-A Latch Enable Input (Active LOW)	1.0/1.0	20 μ A/-0.6 mA
A_0 - A_7	A-to-B Data Inputs or B-to-A 3-STATE Outputs	3.5/1.083 150/40 (33.8)	70 μ A/-650 μ A -3 mA/24 mA (20 mA)
B_0 - B_7	B-to-A Data Inputs or A-to-B 3-STATE Outputs	3.5/1.083 600/106.6 (80)	70 μ A/-650 μ A -12 mA/64 mA (48 mA)

Functional Description

The F543 contains two sets of eight D-type latches, with separate input and output controls for each set. For data flow from A to B, for example, the A-to-B Enable (\overline{CEAB}) input must be LOW in order to enter data from A_0 - A_7 or take data from B_0 - B_7 , as indicated in the Data I/O Control Table. With \overline{CEAB} LOW, a LOW signal on the A-to-B Latch Enable (\overline{LEAB}) input makes the A-to-B latches transparent; a subsequent LOW-to-HIGH transition of the \overline{LEAB} signal puts the A latches in the storage mode and their outputs no longer change with the A inputs. With \overline{CEAB} and \overline{OEAB} both LOW, the 3-STATE B output buffers are active and reflect the data present at the output of the A latches. Control of data flow from B to A is similar, but using the \overline{CEBA} , \overline{LEBA} and \overline{OEBA} inputs.

Data I/O Control Table

Inputs			Latch	Output
\overline{CEAB}	\overline{LEAB}	\overline{OEAB}	Status	Buffers
H	X	X	Latched	High Z
X	H	X	Latched	—
L	L	X	Transparent	—
X	X	H	—	High Z
L	X	L	—	Driving

H = HIGH Voltage Level

L = LOW Voltage Level

X = Immaterial

A-to-B data flow shown; B-to-A flow control is the same, except using \overline{CEBA} , \overline{LEBA} and \overline{OEBA}

Logic Diagram

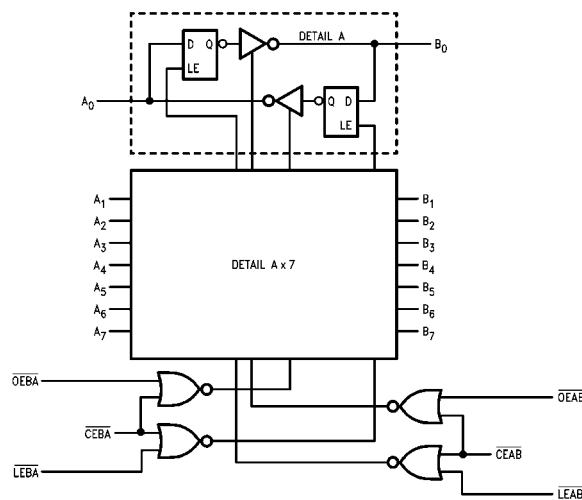

Please note that this diagram is provided only for the understanding of logic operations and should not be used to estimate propagation delays.

Absolute Maximum Ratings (Note 1)

Storage Temperature	-65°C to +150°C
Ambient Temperature under Bias	-55°C to +125°C
Junction Temperature under Bias	-55°C to +150°C
V _{CC} Pin Potential to Ground Pin	-0.5V to +7.0V
Input Voltage (Note 2)	-0.5V to +7.0V
Input Current (Note 2)	-30 mA to +5.0 mA

Voltage Applied to Output

in HIGH State (with V_{CC} = 0V)Standard Output -0.5V to V_{CC}

3-STATE Output -0.5V to +5.5V

Current Applied to Output

in LOW State (Max) twice the rated I_{OL} (mA)**Recommended Operating Conditions**

Free Air Ambient Temperature	0°C to +70°C
Supply Voltage	+4.5V to +5.5V

Note 1: Absolute maximum ratings are values beyond which the device may be damaged or have its useful life impaired. Functional operation under these conditions is not implied.

Note 2: Either voltage limit or current limit is sufficient to protect inputs.

DC Electrical Characteristics

Symbol	Parameter	Min	Typ	Max	Units	V _{CC}	Conditions
V _{IH}	Input HIGH Voltage	2.0			V		Recognized as a HIGH Signal
V _{IL}	Input LOW Voltage			0.8	V		Recognized as a LOW Signal
V _{CD}	Input Clamp Diode Voltage			-1.2	V	Min	I _{IN} = -18 mA
V _{OH}	Output HIGH Voltage	10% V _{CC}	2.5				I _{OH} = -1 mA (A _n)
		10% V _{CC}	2.4				I _{OH} = -3 mA (A _n , B _n)
		5% V _{CC}	2.7			V	I _{OH} = -1 mA (A _n)
		5% V _{CC}	2.7				I _{OH} = -3 mA (A _n , B _n)
		10% V _{CC}	2.0				I _{OH} = -15 mA (B _n)
V _{OL}	Output LOW Voltage	10% V _{CC}	0.5	0.5	V	Min	I _{OL} = 24 mA (A _n)
		10% V _{CC}		0.55			I _{OL} = 64 mA (B _n)
I _{IH}	Input HIGH Current			5.0	μA	Max	V _{IN} = 2.7V
I _{BVI}	Input HIGH Current Breakdown Test			7.0	μA	Max	(OEAB, OEBA, LEAB, LEBA, CEAB, CEBA)
I _{BVIT}	Input HIGH Current Breakdown (I/O)			0.5	mA	Max	V _{IN} = 5.5V (A _n , B _n)
I _{CEX}	Output HIGH Leakage Current			50	μA	Max	V _{OUT} = V _{CC}
V _{ID}	Input Leakage Test	4.75			V	0.0	I _{ID} = 1.9 μA All Other Pins Grounded
I _{OD}	Output Leakage Circuit Current			3.75	μA	0.0	V _{IOD} = 150 mV All Other Pins Grounded
I _{IL}	Input LOW Current			-0.6	mA	Max	V _{IN} = 0.5V (OEAB, OEBA)
				-1.2			V _{IN} = 0.5V (CEAB, CEBA)
I _{IH} + I _{OZH}	Output Leakage Current			70	μA	Max	V _{OUT} = 2.7V (A _n , B _n)
I _{IL} + I _{OZL}	Output Leakage Current			-650	μA	Max	V _{OUT} = 0.5V (A _n , B _n)
I _{OS}	Output Short-Circuit Current			-60	mA	Max	V _{OUT} = 0V (A _n)
				-100			V _{OUT} = 0V (B _n)
I _{ZZ}	Bus Drainage Test			500	μA	0.0V	V _{OUT} = 5.25V (A _n , B _n)
I _{CCH}	Power Supply Current		67	100	mA	Max	V _O = HIGH
I _{CCL}	Power Supply Current		83	125	mA	Max	V _O = LOW
I _{CCZ}	Power Supply Current		83	125	mA	Max	V _O = HIGH Z

AC Electrical Characteristics							
Symbol	Parameter	$T_A = +25^\circ\text{C}$ $V_{CC} = +5.0\text{V}$ $C_L = 50\text{ pF}$			$T_A = 0^\circ\text{C to } +70^\circ\text{C}$ $C_L = 50\text{ pF}$		Units
		Min	Typ	Max	Min	Max	
t_{PLH} t_{PHL}	Propagation Delay Transparent Mode A_n to B_n or B_n to A_n	3.0 3.0	5.5 5.0	7.5 6.5	3.0 3.0	8.5 7.5	ns
t_{PLH} t_{PHL}	Propagation Delay \overline{LEBA} to A_n	4.5 4.5	8.5 8.5	11.0 11.0	4.5 4.5	12.5 12.5	
t_{PLH} t_{PHL}	Propagation Delay \overline{LEAB} to B_n	4.5 4.5	8.5 8.5	11.0 11.0	4.5 4.5	12.5 12.5	ns
t_{PZH} t_{PZL}	Output Enable Time \overline{OEBA} or \overline{OEAB} to A_n or B_n \overline{CEBA} or \overline{CEAB} to A_n or B_n	3.0 4.0	7.0 7.5	9.0 10.5	3.0 4.0	10.0 12.0	ns
t_{PHZ} t_{PLZ}	Output Disable Time \overline{OEBA} or \overline{OEAB} to A_n or B_n \overline{CEBA} or \overline{CEAB} to A_n or B_n	1.0 2.5	6.0 5.5	8.0 10.5	1.0 2.5	9.0 11.5	
AC Operating Requirements							
Symbol	Parameter	$T_A = +25^\circ\text{C}$ $V_{CC} = +5.0\text{V}$		$T_A = 0^\circ\text{C to } +70^\circ\text{C}$		Units	
		Min	Max	Min	Max		
$t_S(H)$ $t_S(L)$	Setup Time, HIGH or LOW A_n or B_n to \overline{LEBA} or \overline{LEAB}	3.0 3.0		3.5 3.5		ns	
$t_H(H)$ $t_H(L)$	Hold Time, HIGH or LOW A_n or B_n to \overline{LEBA} or \overline{LEAB}	3.0 3.0		3.5 3.5			
$t_W(L)$	Latch Enable, B to A or B to A Pulse Width, LOW	8.0		9.0		ns	

Physical Dimensions inches (millimeters) unless otherwise noted

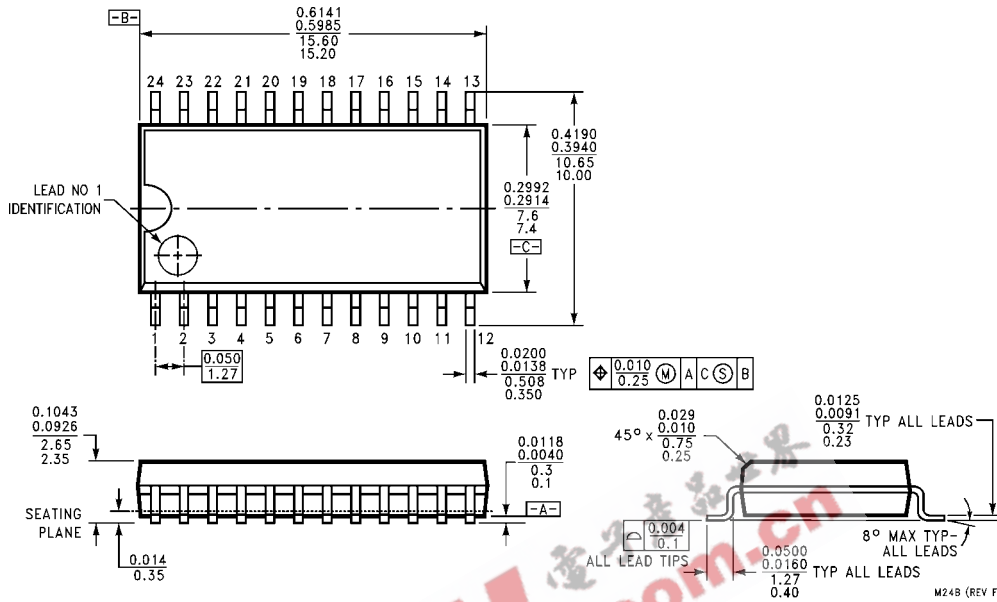

24-Lead Small Outline Integrated Circuit (SOIC), JEDEC MS-013, 0.300 Wide Package Number M24B

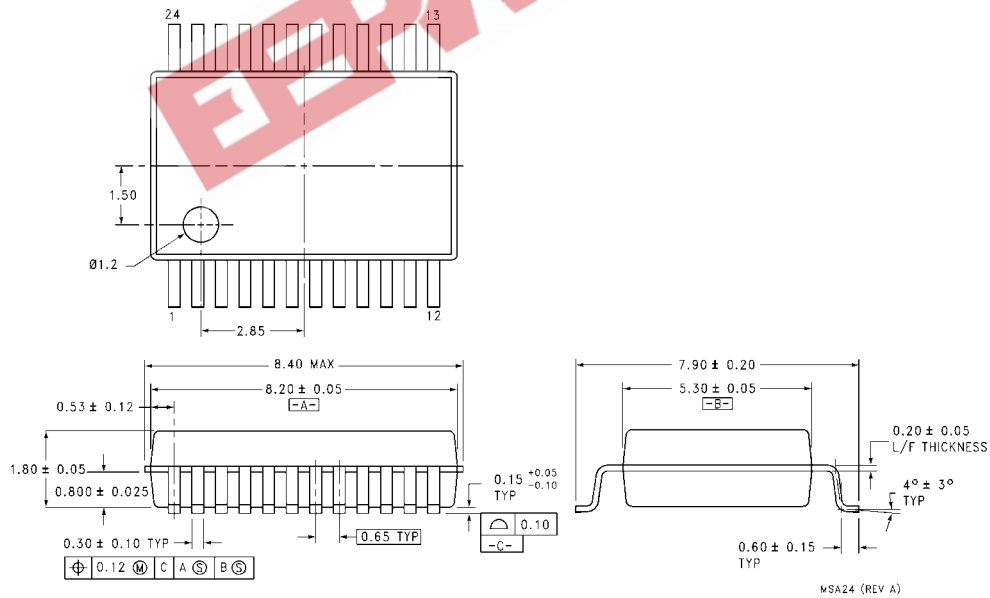

24-Lead Shrink Small Outline Package (SSOP), EIAJ TYPE II, 5.3mm Wide Package Number MSA24

Physical Dimensions inches (millimeters) unless otherwise noted (Continued)

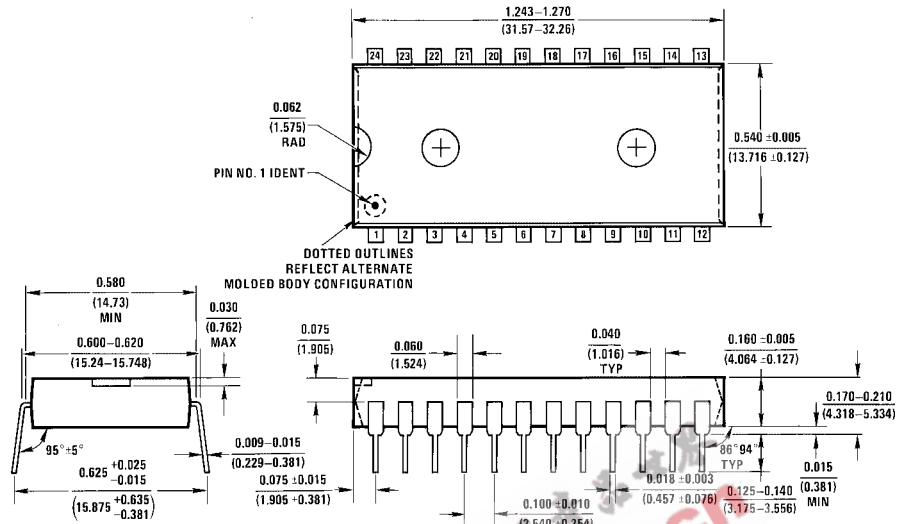

N24A (REV E)

**24-Lead Plastic Dual-In-Line Package (PDIP), JEDEC MS-011, 0.600 Wide
Package Number N24A**

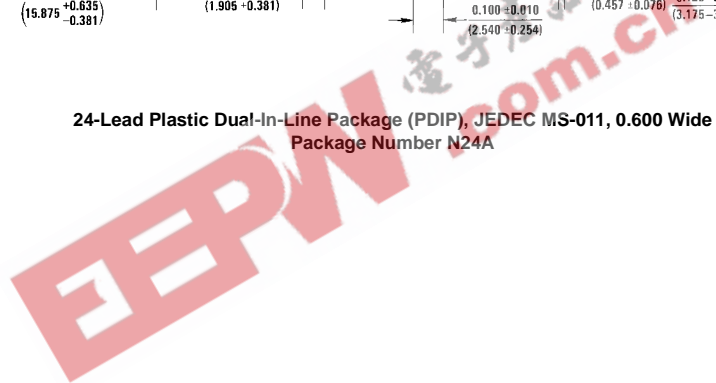

Physical Dimensions inches (millimeters) unless otherwise noted (Continued)

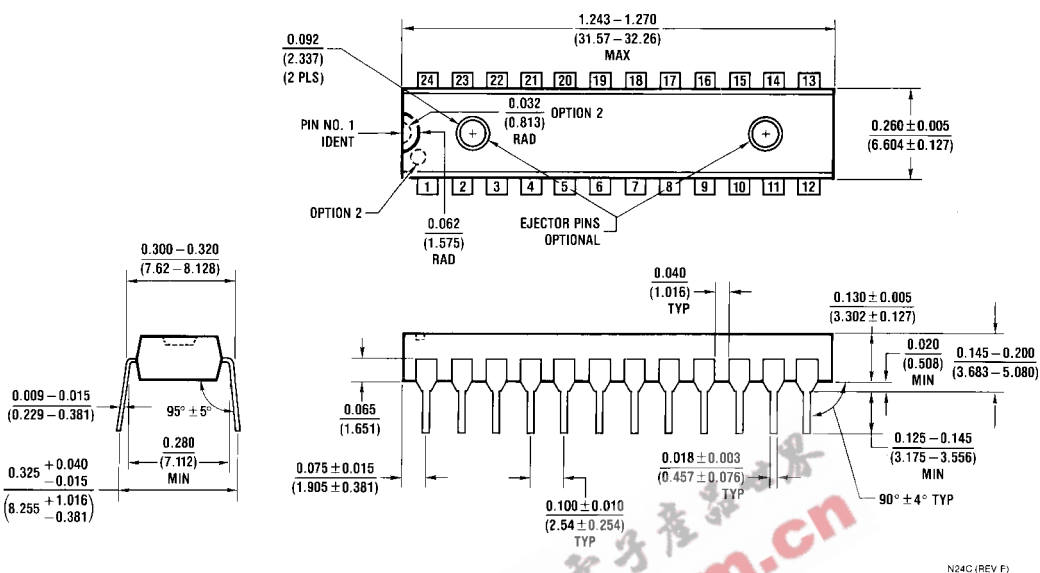

24-Lead Plastic Dual-In-Line Package (PDIP), JEDEC MS-001, 0.300 Wide
Package Number N24C

N24C (REV F)

Fairchild does not assume any responsibility for use of any circuitry described, no circuit patent licenses are implied and Fairchild reserves the right at any time without notice to change said circuitry and specifications.

LIFE SUPPORT POLICY

FAIRCHILD'S PRODUCTS ARE NOT AUTHORIZED FOR USE AS CRITICAL COMPONENTS IN LIFE SUPPORT DEVICES OR SYSTEMS WITHOUT THE EXPRESS WRITTEN APPROVAL OF THE PRESIDENT OF FAIRCHILD SEMICONDUCTOR CORPORATION. As used herein:

1. Life support devices or systems are devices or systems which, (a) are intended for surgical implant into the body, or (b) support or sustain life, and (c) whose failure to perform when properly used in accordance with instructions for use provided in the labeling, can be reasonably expected to result in a significant injury to the user.
2. A critical component in any component of a life support device or system whose failure to perform can be reasonably expected to cause the failure of the life support device or system, or to affect its safety or effectiveness.

www.fairchildsemi.com