

74F821

10-Bit D-Type Flip-Flop

General Description

The 74F821 is a 10-bit D-type flip-flop with 3-STATE true outputs arranged in a broadside pinout.

Features

- 3-STATE Outputs

Ordering Code:

Order Number	Package Number	Package Description
74F821SC	M24B	24-Lead Small Outline Integrated Circuit (SOIC), JEDEC MS-013, 0.300 Wide
74F821SPC	N24C	24-Lead Plastic Dual-In-Line Package (PDIP), JEDEC MS-001, 0.300 Wide

Devices also available in Tape and Reel. Specify by appending the suffix letter "X" to the ordering code.

Logic Symbols

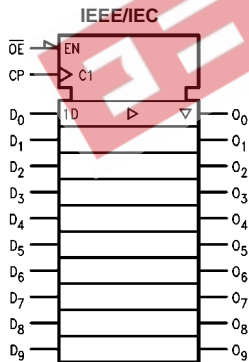
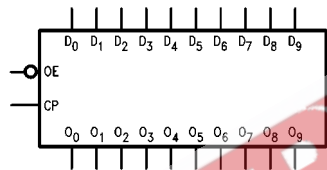

Connection Diagram

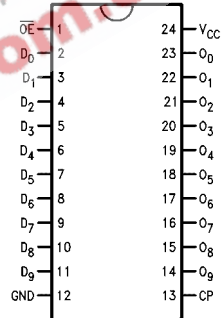

Unit Loading/Fan Out

Pin Names	Description	U.L. HIGH/LOW	Input I_{IH}/I_{IL} Output I_{OH}/I_{OL}
D_0 – D_9	Data Inputs	1.0/1.0	20 μ A/–0.6 mA
\overline{OE}	Output Enable 3-STATE Input	1.0/1.0	20 μ A/–0.6 mA
CP	Clock Input	1.0/1.0	20 μ A/–0.6 mA
O_0 – O_9	3-STATE Outputs	150/40 (33.3)	–3.0 mA/24 mA (20 mA)

Functional Description

The 74F821 consists of ten D-type edge-triggered flip-flops. This device has 3-STATE true outputs for bus systems organized in a broadside pinning. The buffered Clock (CP) and buffered Output Enable (\overline{OE}) are common to all flip-flops. The flip-flops will store the state of their individual D inputs that meet the setup and hold times requirements on the LOW-to-HIGH CP transition. With the \overline{OE} LOW the content of the flip-flops are available at the outputs. When the \overline{OE} is HIGH, the outputs go to the high impedance state. Operation of the \overline{OE} input does not affect the state of the flip-flops.

Function Table

Inputs			Internal	Output	Function
\overline{OE}	CP	D	\overline{Q}	O	
H	H	X	NC	Z	Hold
H	L	X	NC	Z	Hold
H	↗	L	H	Z	Load
H	↗	H	L	Z	Load
L	↗	L	H	L	Data Available
L	↗	H	L	H	Data Available
L	H	X	NC	NC	No Change in Data
L	L	X	NC	NC	No Change in Data

L = LOW Voltage Level
H = HIGH Voltage Level
X = Immaterial
Z = High Impedance
↗ = LOW-to-HIGH Transition
NC = No Change

Logic Diagram

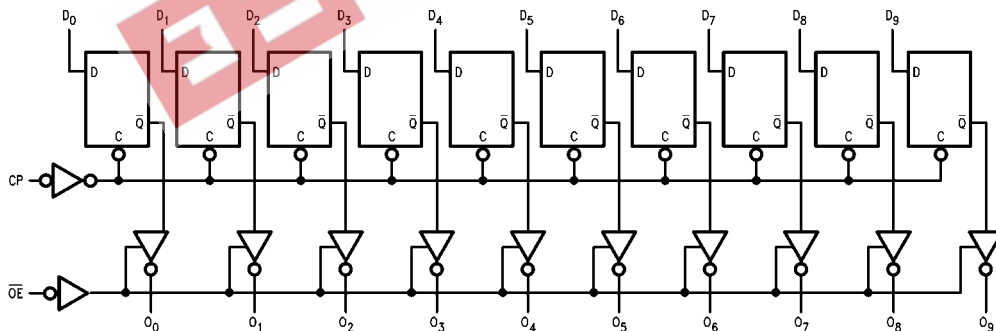

Please note that this diagram is provided only for the understanding of logic operations and should not be used to estimate propagation delays.

Absolute Maximum Ratings (Note 1)

Storage Temperature	-65°C to +150°C
Ambient Temperature under Bias	-55°C to +125°C
Junction Temperature under Bias	-55°C to +150°C
V _{CC} Pin Potential to Ground Pin	-0.5V to +7.0V
Input Voltage (Note 2)	-0.5V to +7.0V
Input Current (Note 2)	-30 mA to +5.0 mA
Voltage Applied to Output in HIGH State (with V _{CC} = 0V)	
Standard Output	-0.5V to V _{CC}
3-STATE Output	-0.5V to +5.5V
Current Applied to Output in LOW State (Max)	twice the rated I _{OL} (mA)

Recommended Operating Conditions

Free Air Ambient Temperature	0°C to +70°C
Supply Voltage	+4.5V to +5.5V

Note 1: Absolute maximum ratings are values beyond which the device may be damaged or have its useful life impaired. Functional operation under these conditions is not implied.

Note 2: Either voltage limit or current limit is sufficient to protect inputs.

DC Electrical Characteristics

Symbol	Parameter	Min	Typ	Max	Units	V _{CC}	Conditions
V _{IH}	Input HIGH Voltage	2.0			V		Recognized as a HIGH Signal
V _{IL}	Input LOW Voltage			0.8	V		Recognized as a LOW Signal
V _{CD}	Input Clamp Diode Voltage			-1.2	V	Min	I _{IN} = -18 mA
V _{OH}	Output HIGH Voltage	10% V _{CC}	2.5		V	Min	I _{OH} = -1 mA
		10% V _{CC}	2.4	I _{OH} = -3 mA			
		5% V _{CC}	2.7	I _{OH} = -1 mA			
		5% V _{CC}	2.7	I _{OH} = -3 mA			
V _{OL}	Output LOW Voltage	10% V _{CC}		0.5	V	Min	I _{OL} = 24 mA
I _{IH}	Input HIGH Current			5.0	μA	Max	V _{IN} = 2.7V
I _{BVI}	Input HIGH Current Breakdown Test			7.0	μA	Max	V _{IN} = 7.0V
I _{CEX}	Output HIGH Leakage Current			50	μA	Max	V _{OUT} = V _{CC}
V _{ID}	Input Leakage Test	4.75			V	0.0	I _{ID} = 1.9 μA, All Other Pins Grounded
I _{OD}	Output Leakage Circuit Current			3.75	μA	0.0	V _{IOD} = 150 mV All Other Pins Grounded
I _{IL}	Input LOW Current			-0.6	mA	Max	V _{IN} = 0.5V
I _{OZH}	Output Leakage Current			50	μA	Max	V _{OUT} = 2.7V
I _{OZL}	Output Leakage Current			-50	μA	Max	V _{OUT} = 0.5V
I _{OS}	Output Short-Circuit Current	-60		-150	mA	Max	V _{OUT} = 0V
I _{CCZ}	Power Supply Current		78	100	mA	Max	V _O = HIGH Z

AC Electrical Characteristics									
Symbol	Parameter	T _A = +25°C V _{CC} = +5.0V C _L = 50 pF			T _A = -55°C to +125°C V _{CC} = +5.0V C _L = 50 pF		T _A = 0°C to +70°C V _{CC} = +5.0V C _L = 50 pF		Units
		Min	Typ	Max	Min	Max	Min	Max	
t _{MAX}	Maximum Clock Frequency	100	150	9.5	60	10.5	70		MHz
t _{PLH}	Propagation Delay	2.0	6.4	9.5	2.0	10.5	2.0	10.5	ns
t _{PHL}	CP to O _n	2.0	6.2	9.5	2.0	10.5	2.0	10.5	
t _{PZH}	Output Enable Time	2.0	5.8	10.5	2.0	13.0	2.0	11.5	ns
t _{PZL}	\overline{OE} to O _n	2.0	6.3	10.5	2.0	13.0	2.0	11.5	
t _{PHZ}	Output Disable Time	1.5	3.4	7.0	1.0	7.5	1.5	7.5	
t _{PLZ}	\overline{OE} to O _n	1.5	3.5	7.0	1.0	7.5	1.5	7.5	
AC Operating Requirements									
Symbol	Parameter	T _A = +25°C V _{CC} = +5.0V		T _A = -55°C to +125°C V _{CC} = +5.0V		T _A = 0°C to +70°C V _{CC} = +5.0V		Units	
		Min	Max	Min	Max	Min	Max		
t _S (H)	Setup Time, HIGH or LOW	2.5		4.0		3.0		ns	
t _S (L)	D _n to CP	2.5		4.0		3.0			
t _H (H)	Hold Time, HIGH or LOW	2.5		2.5		2.5		ns	
t _H (L)	D _n to CP	2.5		2.5		2.5			
t _W (H)	CP Pulse Width	5.0		6.0		6.0		ns	
t _W (L)	HIGH or LOW	5.0		6.0		6.0			

Physical Dimensions inches (millimeters) unless otherwise noted

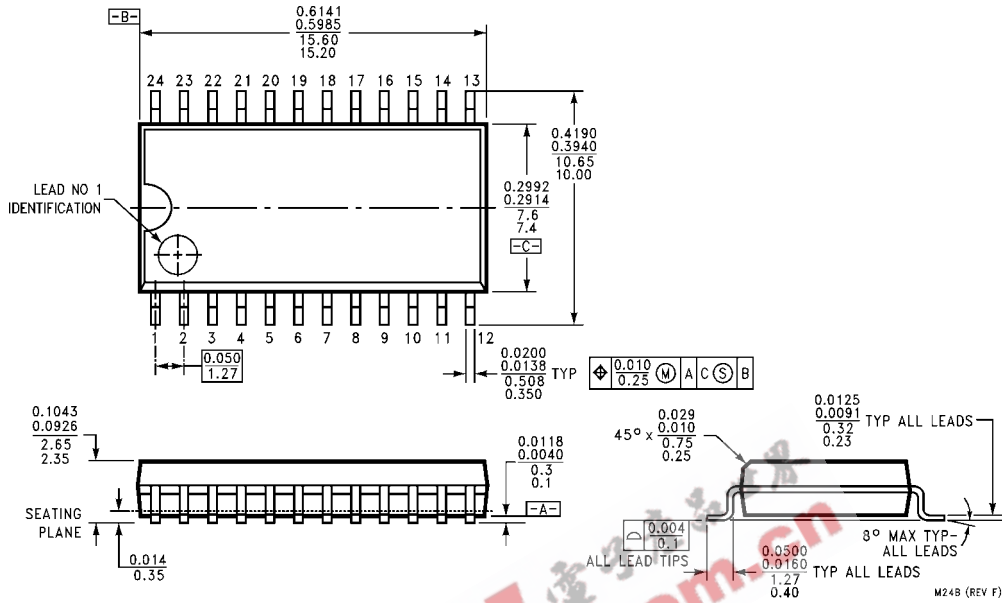

24-Lead Small Outline Integrated Circuit (SOIC), JEDEC MS-013, 0.300 Wide
Package Number M24B

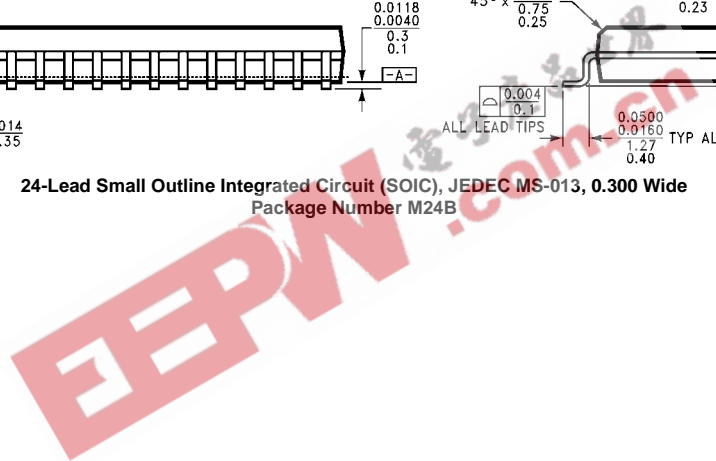

Physical Dimensions inches (millimeters) unless otherwise noted (Continued)

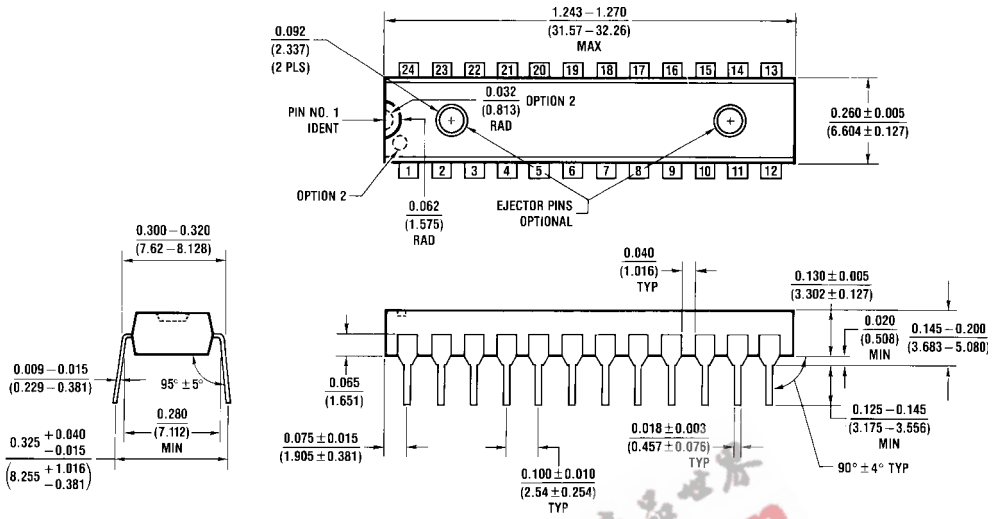

24-Lead Plastic Dual-In-Line Package (PDIP), JEDEC MS-001, 0.300 Wide Package Number N24C

Fairchild does not assume any responsibility for use of any circuitry described, no circuit patent licenses are implied and Fairchild reserves the right at any time without notice to change said circuitry and specifications.

LIFE SUPPORT POLICY

FAIRCHILD'S PRODUCTS ARE NOT AUTHORIZED FOR USE AS CRITICAL COMPONENTS IN LIFE SUPPORT DEVICES OR SYSTEMS WITHOUT THE EXPRESS WRITTEN APPROVAL OF THE PRESIDENT OF FAIRCHILD SEMICONDUCTOR CORPORATION. As used herein:

1. Life support devices or systems are devices or systems which, (a) are intended for surgical implant into the body, or (b) support or sustain life, and (c) whose failure to perform when properly used in accordance with instructions for use provided in the labeling, can be reasonably expected to result in a significant injury to the user.
2. A critical component in any component of a life support device or system whose failure to perform can be reasonably expected to cause the failure of the life support device or system, or to affect its safety or effectiveness.

www.fairchildsemi.com