

74LVX373 Low Voltage Octal Transparent Latch with TRI-STATE® Outputs

General Description

The LVX373 consists of eight latches with TRI-STATE outputs for bus organized system applications. The latches appear transparent to the data when Latch Enable (LE) is HIGH. When LE is low, the data satisfying the input timing requirements is latched. Data appears on the bus when the Output Enable (OE) is LOW. When OE is HIGH, the bus output is in the high impedance state. The inputs tolerate up to 7V allowing interface of 5V systems to 3V systems.

Features

- Input voltage translation from 5V to 3V
- Ideal for low power/low noise 3.3V applications
- Available in SOIC JEDEC, SOIC EIAJ and TSSOP packages
- Guaranteed simultaneous switching noise level and dynamic threshold performance

Logic Symbols

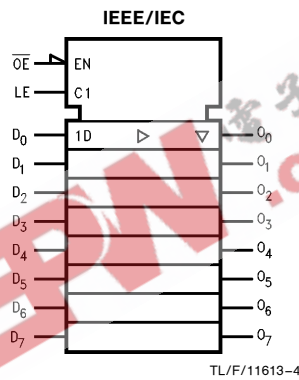
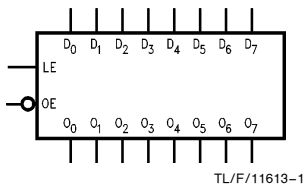

Connection Diagram

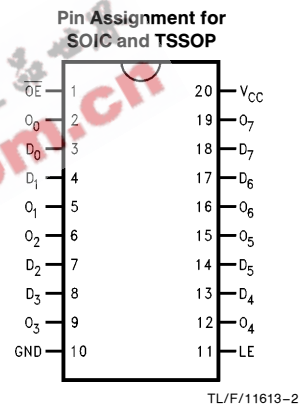

Pin Names	Description
D ₀ -D ₇	Data Inputs
LE	Latch Enable Input
OE	Output Enable Input
O ₀ -O ₇	TRI-STATE Latch Outputs

	SOIC JEDEC	SOIC EIAJ	TSSOP
Order Number	74LVX373M 74LVX373MX	74LVX373SJ 74LVX373SJX	74LVX373MTC 74LVX373MTCX
See NS Package Number	M20B	M20D	MTC20

TRI-STATE® is a registered trademark of National Semiconductor Corporation.

Functional Description

The LVX373 contains eight D-type latches with TRI-STATE standard outputs. When the Latch Enable (LE) input is HIGH, data on the D_n inputs enters the latches. In this condition the latches are transparent, i.e., a latch output will change state each time its D input changes. When LE is LOW, the latches store the information that was present on the D inputs a setup time preceding the HIGH-to-LOW transition of LE. The TRI-STATE standard outputs are controlled by the Output Enable (\overline{OE}) input. When \overline{OE} is LOW, the standard outputs are in the 2-state mode. When \overline{OE} is HIGH, the standard outputs are in the high impedance mode but this does not interfere with entering new data into the latches.

Truth Table

Inputs			Outputs
LE	\overline{OE}	D_n	O_n
X	H	X	Z
H	L	L	L
H	L	H	H
L	L	X	O_0

H = HIGH Voltage Level
 L = LOW Voltage Level
 Z = High Impedance
 X = Immaterial
 O_0 = Previous O_0 before HIGH to Low transition of Latch Enable

Logic Diagram

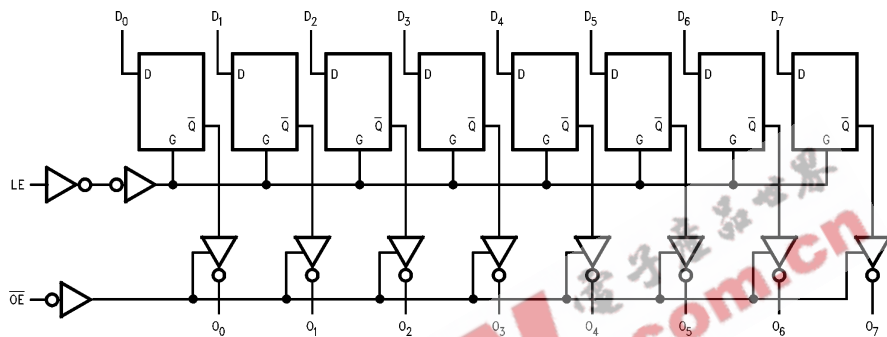

TL/F/11613-3

Please note that this diagram is provided only for the understanding of logic operations and should not be used to estimate propagation delays.

Absolute Maximum Ratings (Note)

If Military/Aerospace specified devices are required, please contact the National Semiconductor Sales Office/Distributors for availability and specifications.

Supply Voltage (V_{CC})	-0.5V to +7.0V
DC Input Diode Current (I_{IK}) $V_I = -0.5V$	-20 mA
DC Input Voltage (V_I)	-0.5V to 7V
DC Output Diode Current (I_{OK}) $V_O = -0.5V$	-20 mA
$V_O = V_{CC} + 0.5V$	+20 mA
DC Output Voltage (V_O)	-0.5V to $V_{CC} + 0.5V$
DC Output Source or Sink Current (I_O)	± 25 mA
DC V_{CC} or Ground Current (I_{CC} or I_{GND})	± 75 mA
Storage Temperature (T_{STG})	-65°C to +150°C
Power Dissipation	180 mW

Note: The "Absolute Maximum Ratings" are those values beyond which the safety of the device cannot be guaranteed. The device should not be operated at these limits. The parametric values defined in the "Electrical Characteristics" table are not guaranteed at the absolute maximum ratings. The "Recommended Operating Conditions" table will define the conditions for actual device operation.

Recommended Operating Conditions

Supply Voltage (V_{CC})	2.0V to 3.6V
Input Voltage (V_I)	0V to 5.5V
Output Voltage (V_O)	0V to V_{CC}
Operating Temperature (T_A)	-40°C to +85°C
Input Rise and Fall Time ($\Delta t/\Delta V$)	0 ns/V to 100 ns/V

DC Electrical Characteristics

Symbol	Parameter	V_{CC}	74LVX373			74LVX373		Units	Conditions
			$T_A = +25^\circ C$			$T_A = -40^\circ C$ to $+85^\circ C$			
			Min	Typ	Max	Min	Max		
V_{IH}	High Level Input Voltage	2.0 3.0 3.6	1.5 2.0 2.4			1.5 2.0 2.4	V		
V_{IL}	Low Level Input Voltage	2.0 3.0 3.6		0.5 0.8 0.8		0.5 0.8 0.8	V		
V_{OH}	High Level Output Voltage	2.0 3.0 3.0	1.9 2.9 2.58	2.0 3.0		1.9 2.9 2.48	V	$V_{IN} = V_{IH}$ or V_{IL} $I_{OH} = -50 \mu A$ $I_{OH} = -50 \mu A$ $I_{OH} = -4 mA$	
V_{OL}	Low Level Output Voltage	2.0 3.0 3.0		0.0 0.0 0.36		0.1 0.1 0.44	V	$V_{IN} = V_{IH}$ or V_{IL} $I_{OL} = 50 \mu A$ $I_{OL} = 50 \mu A$ $I_{OL} = 4 mA$	
I_{OZ}	TRI-STATE Output Off-State Current	3.6		± 0.25		± 2.5	μA	$V_{IN} = V_{IH}$ or V_{IL} $V_{OUT} = V_{CC}$ or GND	
I_{IN}	Input Leakage Current	3.6		± 0.1		± 1.0	μA	$V_{IN} = 5.5V$ or GND	
I_{CC}	Quiescent Supply Current	3.6		4.0		40.0	μA	$V_{IN} = V_{CC}$ or GND	

Noise Characteristics

Symbol	Parameter	V _{CC} (V)	74LVX373		Units	C _L (pF)
			T _A = 25°C			
			Typ	Limit		
V _{OLP}	Quiet Output Maximum Dynamic V _{OL}	3.3	0.5	0.8	V	50
V _{OLV}	Quiet Output Minimum Dynamic V _{OL}	3.3	-0.5	-0.8	V	50
V _{IHD}	Minimum High Level Dynamic Input Voltage	3.3		2.0	V	50
V _{ILD}	Maximum Low Level Dynamic Input Voltage	3.3		0.8	V	50

Note: Input t_r = t_f = 3 ns.

AC Electrical Characteristics

Symbol	Parameter	V _{CC} (V)	74LVX373			74LVX373		Units	Conditions
			T _A = +25°C			T _A = -40°C to +85°C			
			Min	Typ	Max	Min	Max		
t _{PLH} t _{PHL}	Propagation Delay Time D _n to O _n	2.7	7.7	15.0	1.0	18.5	ns	C _L = 15 pF	
			10.2	18.5	1.0	22.0		C _L = 50 pF	
		3.3 ± 0.3	6.0	9.7	1.0	11.5		C _L = 15 pF	
			8.5	13.2	1.0	15.0		C _L = 50 pF	
t _{PLH} t _{PHL}	Propagation Delay Time LE to O _n	2.7	7.5	14.5	1.0	17.5	ns	C _L = 15 pF	
			10.0	18.0	1.0	21.0		C _L = 50 pF	
		3.3 ± 0.3	5.8	9.3	1.0	11.0		C _L = 15 pF	
			8.3	12.8	1.0	14.5		C _L = 50 pF	
t _{PZL} t _{PZH}	TRI-STATE Output Enable Time	2.7	7.7	15.0	1.0	18.5	ns	C _L = 15 pF, R _L = 1 kΩ	
			10.2	18.5	1.0	22.0		C _L = 50 pF, R _L = 1 kΩ	
		3.3 ± 0.3	6.0	9.7	1.0	11.5		C _L = 15 pF, R _L = 1 kΩ	
			8.5	13.2	1.0	15.0		C _L = 50 pF, R _L = 1 kΩ	
t _{PLZ} t _{PHZ}	TRI-STATE Output Disable Time	2.7	9.8	18.0	1.0	21.0	ns	C _L = 50 pF, R _L = 1 kΩ	
		3.3 ± 0.3	8.2	12.8	1.0	14.5		C _L = 50 pF, R _L = 1 kΩ	
t _w	LE Pulse Width, HIGH	2.7	6.5		7.5	ns			
		3.3 ± 0.3	5.0		5.0				
t _s	Setup Time, D _n to LE	2.7	6.0		6.0	ns			
		3.3 ± 0.3	4.0		4.0				
t _H	Hold Time, D _n to LE	2.7	1.0		1.0	ns			
		3.3 ± 0.3	1.0		1.0				
t _{OSLH} t _{OSHL}	Output to Output Skew (Note 1)	2.7		1.5		1.5	ns	C _L = 50 pF	

Note 1: Parameter guaranteed by design. t_{OSLH} = |t_{PLHm} - t_{PLHn}|, t_{OSHL} = |t_{PHLm} - t_{PHLn}|

Capacitance

Symbol	Parameter	74LVX373			74LVX373		Units
		T _A = +25°C			T _A = -40°C to +85°C		
		Min	Typ	Max	Min	Max	
C _{IN}	Input Capacitance	4	10		10	pF	
C _{OUT}	Output Capacitance	6				pF	
C _{PD}	Power Dissipation Capacitance (Note 1)	27				pF	

Note 1: C_{PD} is defined as the value of the internal equivalent capacitance which is calculated from the operating current consumption without load.

Average operating current can be obtained by the equation: $I_{CC(opr.)} = \frac{C_{PD} \times V_{CC} \times f_{IN} + I_{CC}}{8}$ (per Latch)

74LVX373 Ordering Information

The device number is used to form part of a simplified purchasing code where the package type and temperature range are defined as follows:

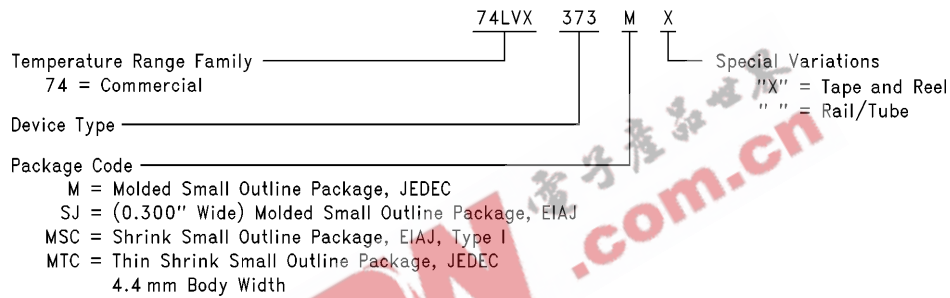

TL/F/11613-5

Physical Dimensions inches (millimeters) unless otherwise noted

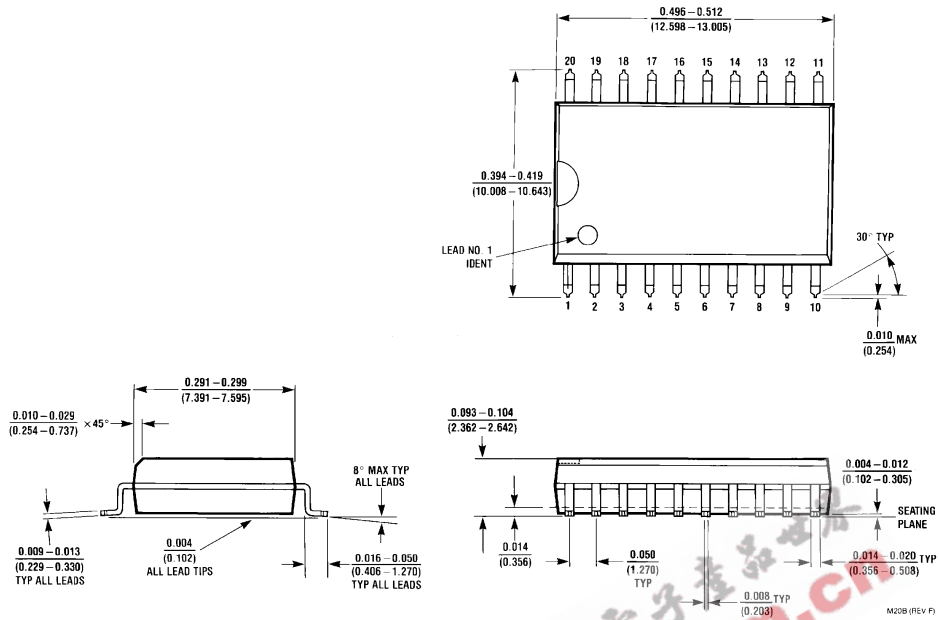

20-Lead Small Outline Integrated Circuit (M)
Order Number 74LVX373M or 74LVX373MX
NS Package Number M20B

www.national.com

M20B (REV. P)

Physical Dimensions inches (millimeters) unless otherwise noted (Continued)

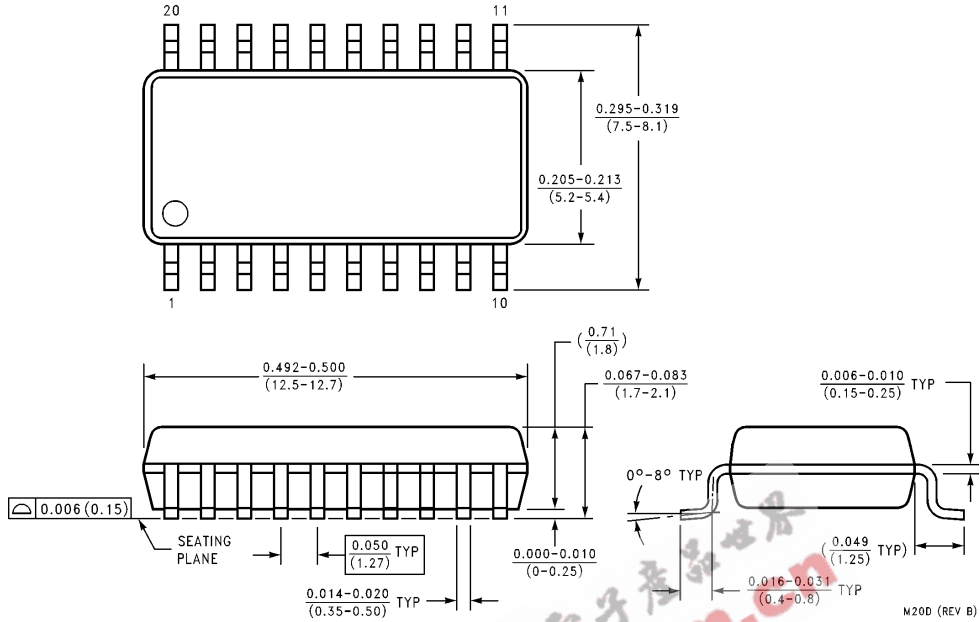

20-Lead Small Outline Package EIAJ SOIC (SJ)
Order Number 74LVX373SJ or 74LVX373SJX
NS Package Number M20D

M20D (REV B)



Physical Dimensions All dimensions are in millimeters (Continued)

DIMENSIONS METRIC ONLY

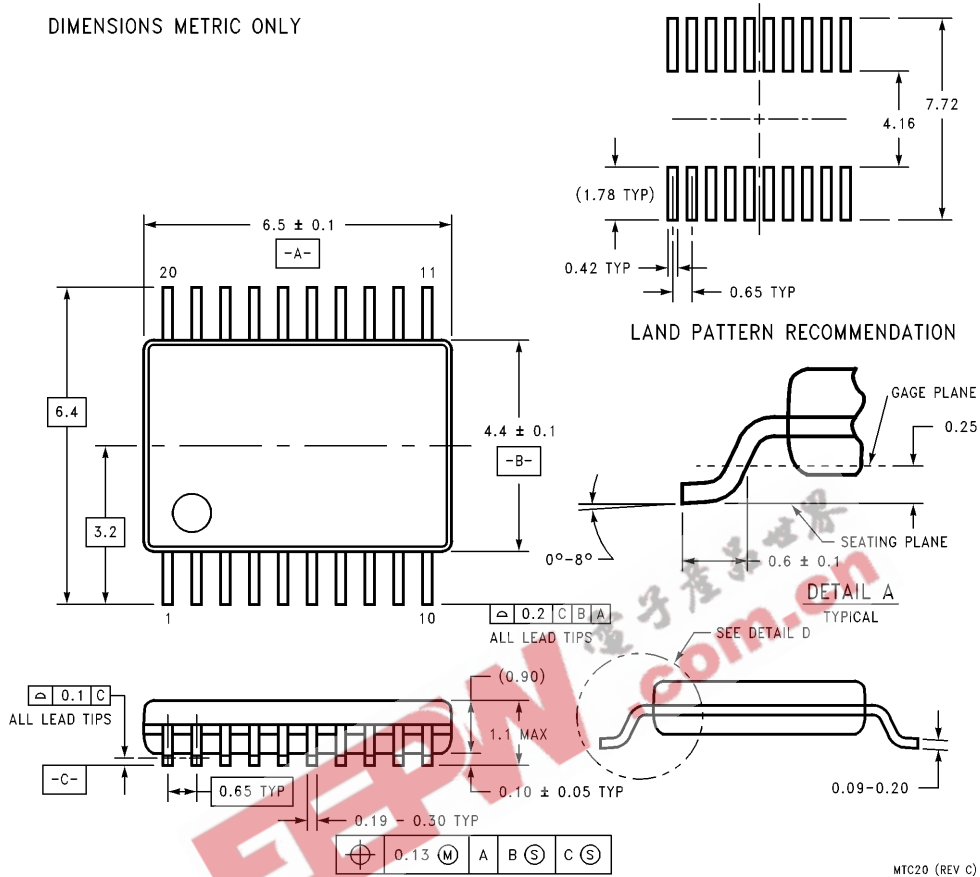

16-Lead Thin Shrink Small Outline Package, JEDEC
Order Number 74LVX373MTC or 74LVX373MTCX
NS Package Number MTC20

MTC20 (REV C)

LIFE SUPPORT POLICY

NATIONAL'S PRODUCTS ARE NOT AUTHORIZED FOR USE AS CRITICAL COMPONENTS IN LIFE SUPPORT DEVICES OR SYSTEMS WITHOUT THE EXPRESS WRITTEN APPROVAL OF THE PRESIDENT OF NATIONAL SEMICONDUCTOR CORPORATION. As used herein:

1. Life support devices or systems are devices or systems which, (a) are intended for surgical implant into the body, or (b) support or sustain life, and whose failure to perform, when properly used in accordance with instructions for use provided in the labeling, can be reasonably expected to result in a significant injury to the user.
2. A critical component is any component of a life support device or system whose failure to perform can be reasonably expected to cause the failure of the life support device or system, or to affect its safety or effectiveness.



National Semiconductor Corporation
Americas
 Tel: 1(800) 272-9959
 Fax: 1(800) 737-7018
 Email: support@nsc.com

National Semiconductor Europe
 Fax: +49 (0) 180-530 85 86
 Email: europe.support@nsc.com
 Deutsch Tel: +49 (0) 180-530 85 85
 English Tel: +49 (0) 180-532 78 32
 Français Tel: +49 (0) 180-532 93 58
 Italiano Tel: +49 (0) 180-534 16 80

National Semiconductor Southeast Asia
 Fax: (852) 2376 3901
 Email: sea.support@nsc.com

National Semiconductor Japan Ltd.
 Tel: 81-3-5620-7561
 Fax: 81-3-5620-6179

<http://www.national.com>

National does not assume any responsibility for use of any circuitry described, no circuit patent licenses are implied and National reserves the right at any time without notice to change said circuitry and specifications.