

DATA SHEET

EEPW 电子产品世界
.com.cn

74AHC3G14; 74AHCT3G14 Inverting Schmitt trigger

Product specification
Supersedes data of 2003 Nov 27

2004 Oct 18

Inverting Schmitt trigger

74AHC3G14; 74AHCT3G14

FEATURES

- Symmetrical output impedance
- High noise immunity
- ESD protection:
 - HBM EIA/JESD22-A114-B exceeds 2000 V
 - MM EIA/JESD22-A115-A exceeds 200 V
 - CDM EIA/JESD22-C101 exceeds 500 V.
- Low power dissipation
- Balanced propagation delays
- Multiple package options
- Specified from $-40\text{ }^{\circ}\text{C}$ to $+85\text{ }^{\circ}\text{C}$ and $-40\text{ }^{\circ}\text{C}$ to $+125\text{ }^{\circ}\text{C}$.

APPLICATIONS

- Wave and pulse shapers
- Astable multivibrators
- Monostable multivibrators.

DESCRIPTION

The 74AHC3G/AHCT3G14 is a high-speed Si-gate CMOS device.

The 74AHC3G/AHCT3G14 provides three inverting buffers with Schmitt-trigger action. These devices are capable of transforming slowly changing input signals into sharply defined, jitter-free output signals.

QUICK REFERENCE DATA

GND = 0 V; $T_{\text{amb}} = 25\text{ }^{\circ}\text{C}$; $t_r = t_f \leq 3.0\text{ ns}$.

| SYMBOL | PARAMETER | CONDITIONS | TYPICAL | | UNIT |
|---------------------------------|-------------------------------|---|---------|----------|------|
| | | | AHC3G14 | AHCT3G14 | |
| $t_{\text{PHL}}/t_{\text{PLH}}$ | propagation delay A to Y | $C_L = 15\text{ pF}$; $V_{\text{CC}} = 5\text{ V}$ | 3.2 | 4.1 | ns |
| C_I | input capacitance | | 1.5 | 1.5 | pF |
| C_{PD} | power dissipation capacitance | $C_L = 15\text{ pF}$; $f = 1\text{ MHz}$; notes 1 and 2 | 10 | 12 | pF |

Notes

1. C_{PD} is used to determine the dynamic power dissipation (P_D in μW).

$$P_D = C_{\text{PD}} \times V_{\text{CC}}^2 \times f_i \times N + \Sigma(C_L \times V_{\text{CC}}^2 \times f_o) \text{ where:}$$

f_i = input frequency in MHz;

f_o = output frequency in MHz;

C_L = output load capacitance in pF;

V_{CC} = supply voltage in Volts;

N = number of inputs switching;

$\Sigma(C_L \times V_{\text{CC}}^2 \times f_o)$ = sum of the outputs.

2. The condition is $V_I = \text{GND to } V_{\text{CC}}$.

FUNCTION TABLE

See note 1.

| INPUT | OUTPUT |
|-------|--------|
| nA | nY |
| L | H |
| H | L |

Note

1. H = HIGH voltage level;
L = LOW voltage level.

Inverting Schmitt trigger

74AHC3G14; 74AHCT3G14

ORDERING INFORMATION

| TYPE NUMBER | PACKAGE | | | | | |
|--------------|-------------------|------|---------|----------|----------|---------|
| | TEMPERATURE RANGE | PINS | PACKAGE | MATERIAL | CODE | MARKING |
| 74AHC3G14DP | -40 °C to +125 °C | 8 | TSSOP8 | plastic | SOT505-2 | A14 |
| 74AHCT3G14DP | -40 °C to +125 °C | 8 | TSSOP8 | plastic | SOT505-2 | C14 |
| 74AHC3G14DC | -40 °C to +125 °C | 8 | VSSOP8 | plastic | SOT765-1 | A14 |
| 74AHCT3G14DC | -40 °C to +125 °C | 8 | VSSOP8 | plastic | SOT765-1 | C14 |
| 74AHC3G14GM | -40 °C to +125 °C | 8 | XSON8 | plastic | SOT833-1 | A14 |
| 74AHCT3G14GM | -40 °C to +125 °C | 8 | XSON8 | plastic | SOT833-1 | C14 |

PINNING

| PIN | SYMBOL | DESCRIPTION |
|-----|-----------------|----------------|
| 1 | 1A | data input |
| 2 | 3Y | data output |
| 3 | 2A | data input |
| 4 | GND | ground (0 V) |
| 5 | 2Y | data output |
| 6 | 3A | data input |
| 7 | 1Y | data output |
| 8 | V _{CC} | supply voltage |

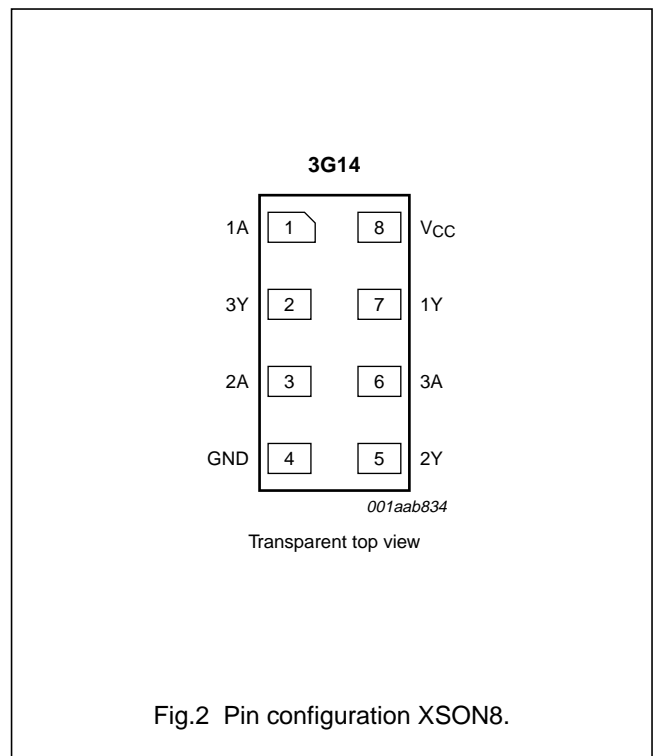
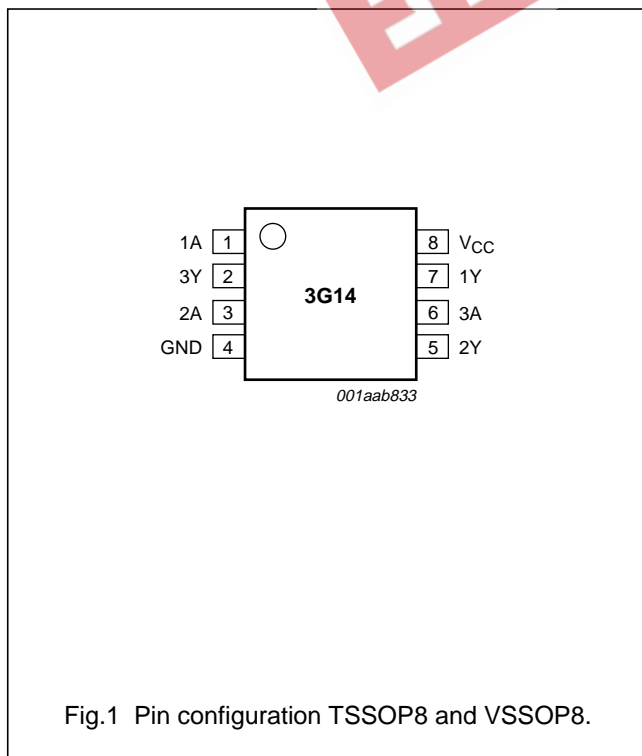

Inverting Schmitt trigger

74AHC3G14; 74AHCT3G14

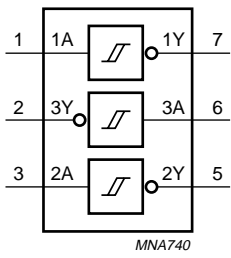

Fig.3 Logic symbol.

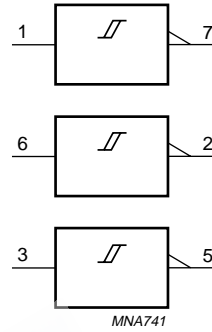

Fig.4 IEC logic symbol.

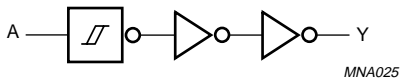

Fig.5 Logic diagram (one driver).

Inverting Schmitt trigger

74AHC3G14; 74AHCT3G14

RECOMMENDED OPERATING CONDITIONS

| SYMBOL | PARAMETER | CONDITIONS | 74AHC3G | | | 74AHCT3G | | | UNIT |
|-----------|-------------------------------|--|---------|------|----------|----------|------|----------|------|
| | | | MIN. | TYP. | MAX. | MIN. | TYP. | MAX. | |
| V_{CC} | supply voltage | | 2.0 | 5.0 | 5.5 | 4.5 | 5.0 | 5.5 | V |
| V_I | input voltage | | 0 | – | 5.5 | 0 | – | 5.5 | V |
| V_O | output voltage | | 0 | – | V_{CC} | 0 | – | V_{CC} | V |
| T_{amb} | operating ambient temperature | see DC and AC characteristics per device | –40 | +25 | +125 | –40 | +25 | +125 | °C |

LIMITING VALUES

In accordance with the Absolute Maximum Rating System (IEC 60134); voltages are referenced to GND (ground = 0 V).

| SYMBOL | PARAMETER | CONDITIONS | MIN. | MAX. | UNIT |
|-------------------|-------------------------------|--|------|------|------|
| V_{CC} | supply voltage | | –0.5 | +7.0 | V |
| V_I | input voltage | | –0.5 | +7.0 | V |
| I_{IK} | input diode current | $V_I < -0.5$ V | – | –20 | mA |
| I_{OK} | output diode current | $V_O < -0.5$ V or $V_O > V_{CC} + 0.5$ V; note 1 | – | ±20 | mA |
| I_O | output source or sink current | -0.5 V < V_O < $V_{CC} + 0.5$ V | – | ±25 | mA |
| I_{CC}, I_{GND} | V_{CC} or GND current | | – | ±75 | mA |
| T_{stg} | storage temperature | | –65 | +150 | °C |
| P_D | power dissipation | $T_{amb} = -40$ °C to +125 °C | – | 250 | mW |

Note

1. The input and output voltage ratings may be exceeded if the input and output current ratings are observed.

Inverting Schmitt trigger

74AHC3G14; 74AHCT3G14

DC CHARACTERISTICS

Type 74AHC3G14

At recommended operating conditions; voltages are referenced to GND (ground = 0 V).

| SYMBOL | PARAMETER | TEST CONDITIONS | | MIN. | TYP. | MAX. | UNIT |
|---|---------------------------|---|---------------------|------|------|------|------|
| | | OTHER | V _{CC} (V) | | | | |
| T_{amb} = 25 °C | | | | | | | |
| V _{OH} | HIGH-level output voltage | V _I = V _{IH} or V _{IL} | | | | | |
| | | I _O = -50 μA | 2.0 | 1.9 | 2.0 | - | V |
| | | I _O = -50 μA | 3.0 | 2.9 | 3.0 | - | V |
| | | I _O = -50 μA | 4.5 | 4.4 | 4.5 | - | V |
| | | I _O = -4.0 mA | 3.0 | 2.58 | - | - | V |
| | | I _O = -8.0 mA | 4.5 | 3.94 | - | - | V |
| V _{OL} | LOW-level output voltage | V _I = V _{IH} or V _{IL} | | | | | |
| | | I _O = 50 μA | 2.0 | - | 0 | 0.1 | V |
| | | I _O = 50 μA | 3.0 | - | 0 | 0.1 | V |
| | | I _O = 50 μA | 4.5 | - | 0 | 0.1 | V |
| | | I _O = 4.0 mA | 3.0 | - | - | 0.36 | V |
| | | I _O = 8.0 mA | 4.5 | - | - | 0.36 | V |
| I _{LI} | input leakage current | V _I = V _{CC} or GND | 5.5 | - | - | 0.1 | μA |
| I _{CC} | quiescent supply current | V _I = V _{CC} or GND; I _O = 0 A | 5.5 | - | - | 1.0 | μA |
| C _I | input capacitance | | - | - | 1.5 | 10 | pF |
| T_{amb} = -40 °C to +85 °C | | | | | | | |
| V _{OH} | HIGH-level output voltage | V _I = V _{IH} or V _{IL} | | | | | |
| | | I _O = -50 μA | 2.0 | 1.9 | - | - | V |
| | | I _O = -50 μA | 3.0 | 2.9 | - | - | V |
| | | I _O = -50 μA | 4.5 | 4.4 | - | - | V |
| | | I _O = -4.0 mA | 3.0 | 2.48 | - | - | V |
| | | I _O = -8.0 mA | 4.5 | 3.8 | - | - | V |
| V _{OL} | LOW-level output voltage | V _I = V _{IH} or V _{IL} | | | | | |
| | | I _O = 50 μA | 2.0 | - | - | 0.1 | V |
| | | I _O = 50 μA | 3.0 | - | - | 0.1 | V |
| | | I _O = 50 μA | 4.5 | - | - | 0.1 | V |
| | | I _O = 4.0 mA | 3.0 | - | - | 0.44 | V |
| | | I _O = 8.0 mA | 4.5 | - | - | 0.44 | V |
| I _{LI} | input leakage current | V _I = V _{CC} or GND | 5.5 | - | - | 1.0 | μA |
| I _{CC} | quiescent supply current | V _I = V _{CC} or GND; I _O = 0 A | 5.5 | - | - | 10 | μA |
| C _I | input capacitance | | - | - | - | 10 | pF |

Inverting Schmitt trigger

74AHC3G14; 74AHCT3G14

| SYMBOL | PARAMETER | TEST CONDITIONS | | MIN. | TYP. | MAX. | UNIT |
|--|---------------------------|--|---------------------|------|------|------|------|
| | | OTHER | V _{CC} (V) | | | | |
| T_{amb} = -40 °C to +125 °C | | | | | | | |
| V _{OH} | HIGH-level output voltage | V _I = V _{IH} or V _{IL} I _O = -50 μA | 2.0 | 1.9 | - | - | V |
| | | I _O = -50 μA | 3.0 | 2.9 | - | - | V |
| | | I _O = -50 μA | 4.5 | 4.4 | - | - | V |
| | | I _O = -4.0 mA | 3.0 | 2.40 | - | - | V |
| | | I _O = -8.0 mA | 4.5 | 3.70 | - | - | V |
| V _{OL} | LOW-level output voltage | V _I = V _{IH} or V _{IL} I _O = 50 μA | 2.0 | - | - | 0.1 | V |
| | | I _O = 50 μA | 3.0 | - | - | 0.1 | V |
| | | I _O = 50 μA | 4.5 | - | - | 0.1 | V |
| | | I _O = 4.0 mA | 3.0 | - | - | 0.55 | V |
| | | I _O = 8.0 mA | 4.5 | - | - | 0.55 | V |
| I _{LI} | input leakage current | V _I = V _{CC} or GND | 5.5 | - | - | 2.0 | μA |
| I _{CC} | quiescent supply current | V _I = V _{CC} or GND; I _O = 0 A | 5.5 | - | - | 40 | μA |
| C _I | input capacitance | | - | - | - | 10 | pF |

Inverting Schmitt trigger

74AHC3G14; 74AHCT3G14

Type 74AHCT3G14

At recommended operating conditions; voltages are referenced to GND (ground = 0 V).

| SYMBOL | PARAMETER | TEST CONDITIONS | | MIN. | TYP. | MAX. | UNIT |
|--|---|--|---------------------|------|------|------|------|
| | | OTHER | V _{CC} (V) | | | | |
| T_{amb} = 25 °C | | | | | | | |
| V _{OH} | HIGH-level output voltage | V _I = V _{IH} or V _{IL} | 4.5 | 4.4 | 4.5 | – | V |
| | | I _O = –50 μA I _O = –8.0 mA | 4.5 | 3.94 | – | – | V |
| V _{OL} | LOW-level output voltage | V _I = V _{IH} or V _{IL} | 4.5 | – | 0 | 0.1 | V |
| | | I _O = 50 μA I _O = 8.0 mA | 4.5 | – | – | 0.36 | V |
| I _{LI} | input leakage current | V _I = V _{IH} or V _{IL} | 5.5 | – | – | 0.1 | μA |
| I _{CC} | quiescent supply current | V _I = V _{CC} or GND; I _O = 0 A | 5.5 | – | – | 1.0 | μA |
| ΔI _{CC} | additional quiescent supply current per input pin | V _I = 3.4 V; other inputs at V _{CC} or GND; I _O = 0 A | 5.5 | – | – | 1.35 | mA |
| C _I | input capacitance | | – | – | 1.5 | 10 | pF |
| T_{amb} = –40 °C to +85 °C | | | | | | | |
| V _{OH} | HIGH-level output voltage | V _I = V _{IH} or V _{IL} | 4.5 | 4.4 | – | – | V |
| | | I _O = –50 μA I _O = –8.0 mA | 4.5 | 3.8 | – | – | V |
| V _{OL} | LOW-level output voltage | V _I = V _{IH} or V _{IL} | 4.5 | – | – | 0.1 | V |
| | | I _O = 50 μA I _O = 8.0 mA | 4.5 | – | – | 0.44 | V |
| I _{LI} | input leakage current | V _I = V _{IH} or V _{IL} | 5.5 | – | – | 1.0 | μA |
| I _{CC} | quiescent supply current | V _I = V _{CC} or GND; I _O = 0 A | 5.5 | – | – | 10 | μA |
| ΔI _{CC} | additional quiescent supply current per input pin | V _I = 3.4 V; other inputs at V _{CC} or GND; I _O = 0 A | 5.5 | – | – | 1.5 | mA |
| C _I | input capacitance | | – | – | – | 10 | pF |
| T_{amb} = –40 °C to +125 °C | | | | | | | |
| V _{OH} | HIGH-level output voltage | V _I = V _{IH} or V _{IL} | 4.5 | 4.4 | – | – | V |
| | | I _O = –50 μA I _O = –8.0 mA | 4.5 | 3.70 | – | – | V |
| V _{OL} | LOW-level output voltage | V _I = V _{IH} or V _{IL} | 4.5 | – | – | 0.1 | V |
| | | I _O = 50 μA I _O = 8.0 mA | 4.5 | – | – | 0.55 | V |
| I _{LI} | input leakage current | V _I = V _{IH} or V _{IL} | 5.5 | – | – | 2.0 | μA |
| I _{CC} | quiescent supply current | V _I = V _{CC} or GND; I _O = 0 A | 5.5 | – | – | 40 | μA |
| ΔI _{CC} | additional quiescent supply current per input pin | V _I = 3.4 V; other inputs at V _{CC} or GND; I _O = 0 A | 5.5 | – | – | 1.5 | mA |
| C _I | input capacitance | | – | – | – | 10 | pF |

Inverting Schmitt trigger

74AHC3G14; 74AHCT3G14

TRANSFER CHARACTERISTICS

Type 74AHC3G14

At recommended operating conditions; voltages are referenced to GND (ground = 0 V).

| SYMBOL | PARAMETER | TEST CONDITIONS | | MIN. | TYP. | MAX. | UNIT |
|--|---|------------------|---------------------|------|------|------|------|
| | | WAVEFORMS | V _{CC} (V) | | | | |
| T_{amb} = 25 °C | | | | | | | |
| V _{T+} | positive-going threshold | see Figs 6 and 7 | 3.0 | – | – | 2.2 | V |
| | | | 4.5 | – | – | 3.15 | V |
| | | | 5.5 | – | – | 3.85 | V |
| V _{T-} | negative-going threshold | see Figs 6 and 7 | 3.0 | 0.9 | – | – | V |
| | | | 4.5 | 1.35 | – | – | V |
| | | | 5.5 | 1.65 | – | – | V |
| V _H | hysteresis (V _{T+} – V _{T-}) | see Figs 6 and 7 | 3.0 | 0.3 | – | 1.2 | V |
| | | | 4.5 | 0.4 | – | 1.4 | V |
| | | | 5.5 | 0.5 | – | 1.6 | V |
| T_{amb} = –40 °C to +85 °C | | | | | | | |
| V _{T+} | positive-going threshold | see Figs 6 and 7 | 3.0 | – | – | 2.2 | V |
| | | | 4.5 | – | – | 3.15 | V |
| | | | 5.5 | – | – | 3.85 | V |
| V _{T-} | negative-going threshold | see Figs 6 and 7 | 3.0 | 0.9 | – | – | V |
| | | | 4.5 | 1.35 | – | – | V |
| | | | 5.5 | 1.65 | – | – | V |
| V _H | hysteresis (V _{T+} – V _{T-}) | see Figs 6 and 7 | 3.0 | 0.3 | – | 1.2 | V |
| | | | 4.5 | 0.4 | – | 1.4 | V |
| | | | 5.5 | 0.5 | – | 1.6 | V |
| T_{amb} = –40 °C to +125 °C | | | | | | | |
| V _{T+} | positive-going threshold | see Figs 6 and 7 | 3.0 | – | – | 2.2 | V |
| | | | 4.5 | – | – | 3.15 | V |
| | | | 5.5 | – | – | 3.85 | V |
| V _{T-} | negative-going threshold | see Figs 6 and 7 | 3.0 | 0.9 | – | – | V |
| | | | 4.5 | 1.35 | – | – | V |
| | | | 5.5 | 1.65 | – | – | V |
| V _H | hysteresis (V _{T+} – V _{T-}) | see Figs 6 and 7 | 3.0 | 0.25 | – | 1.2 | V |
| | | | 4.5 | 0.35 | – | 1.4 | V |
| | | | 5.5 | 0.45 | – | 1.6 | V |

Inverting Schmitt trigger

74AHC3G14; 74AHCT3G14

Type 74AHCT3G14

At recommended operating conditions; voltages are referenced to GND (ground = 0 V).

| SYMBOL | PARAMETER | TEST CONDITIONS | | MIN. | TYP. | MAX. | UNIT |
|--|---|------------------|---------------------|------|------|------|------|
| | | WAVEFORMS | V _{CC} (V) | | | | |
| T_{amb} = 25 °C | | | | | | | |
| V _{T+} | positive-going threshold | see Figs 6 and 7 | 4.5 | – | – | 2.0 | V |
| | | | 5.5 | – | – | 2.0 | V |
| V _{T-} | negative-going threshold | see Figs 6 and 7 | 4.5 | 0.5 | – | – | V |
| | | | 5.5 | 0.6 | – | – | V |
| V _H | hysteresis (V _{T+} – V _{T-}) | see Figs 6 and 7 | 4.5 | 0.4 | – | 1.4 | V |
| | | | 5.5 | 0.4 | – | 1.6 | V |
| T_{amb} = –40 °C to +85 °C | | | | | | | |
| V _{T+} | positive-going threshold | see Figs 6 and 7 | 4.5 | – | – | 2.0 | V |
| | | | 5.5 | – | – | 2.0 | V |
| V _{T-} | negative-going threshold | see Figs 6 and 7 | 4.5 | 0.5 | – | – | V |
| | | | 5.5 | 0.6 | – | – | V |
| V _H | hysteresis (V _{T+} – V _{T-}) | see Figs 6 and 7 | 4.5 | 0.4 | – | 1.4 | V |
| | | | 5.5 | 0.4 | – | 1.6 | V |
| T_{amb} = –40 °C to +125 °C | | | | | | | |
| V _{T+} | positive-going threshold | see Figs 6 and 7 | 4.5 | – | – | 2.0 | V |
| | | | 5.5 | – | – | 2.0 | V |
| V _{T-} | negative-going threshold | see Figs 6 and 7 | 4.5 | 0.5 | – | – | V |
| | | | 5.5 | 0.6 | – | – | V |
| V _H | hysteresis (V _{T+} – V _{T-}) | see Figs 6 and 7 | 4.5 | 0.35 | – | 1.4 | V |
| | | | 5.5 | 0.35 | – | 1.6 | V |

Inverting Schmitt trigger

74AHC3G14; 74AHCT3G14

TRANSFER CHARACTERISTIC WAVEFORMS

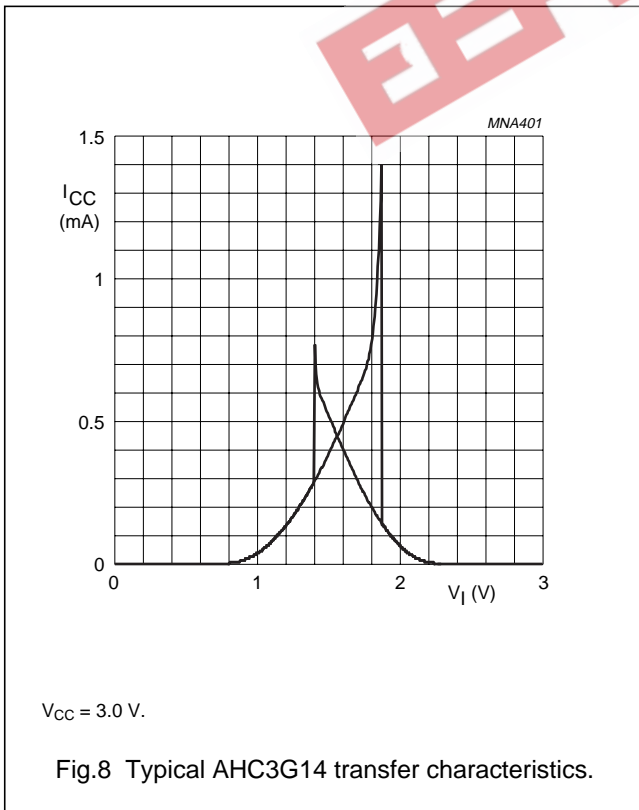
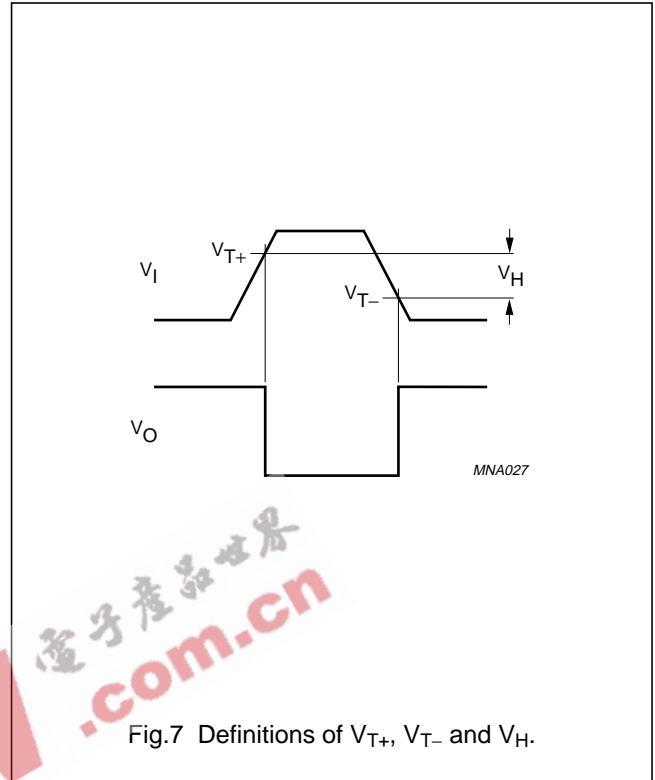
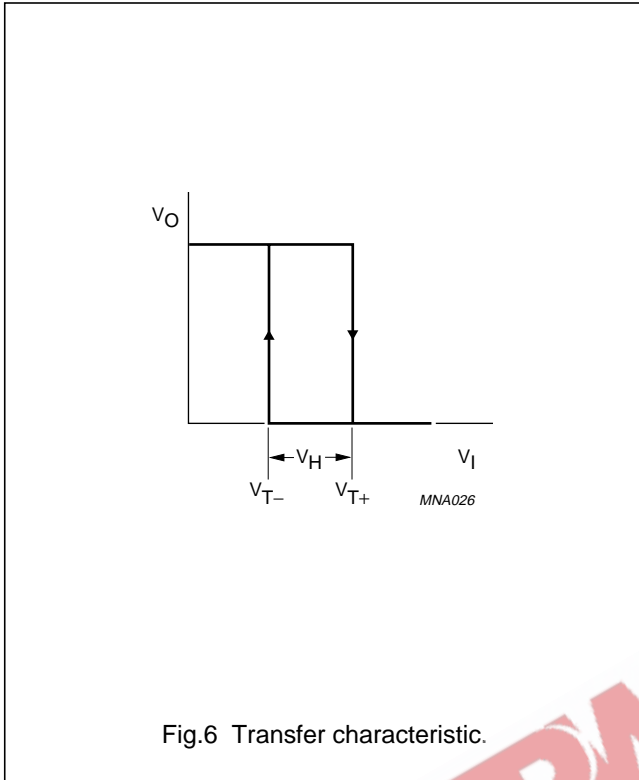

Inverting Schmitt trigger

74AHC3G14; 74AHCT3G14

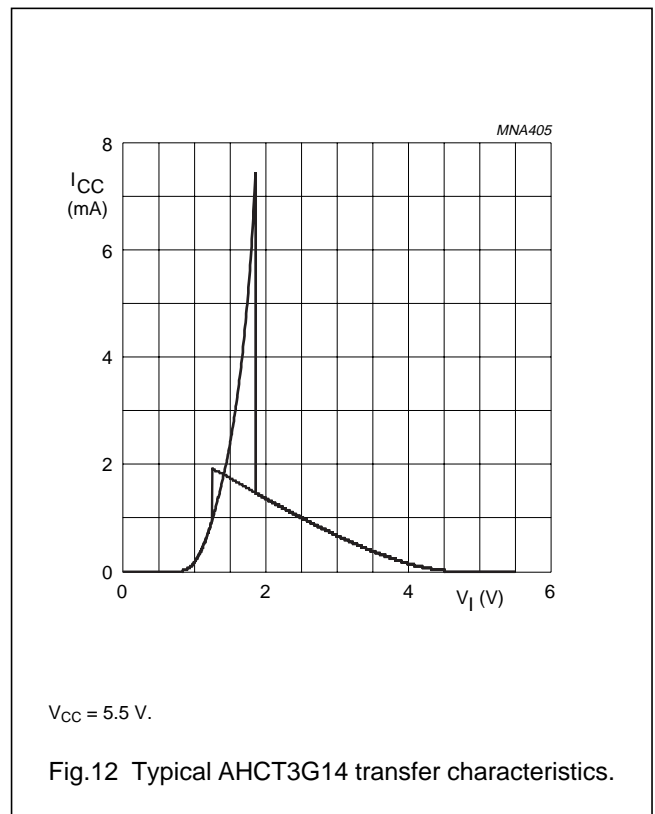
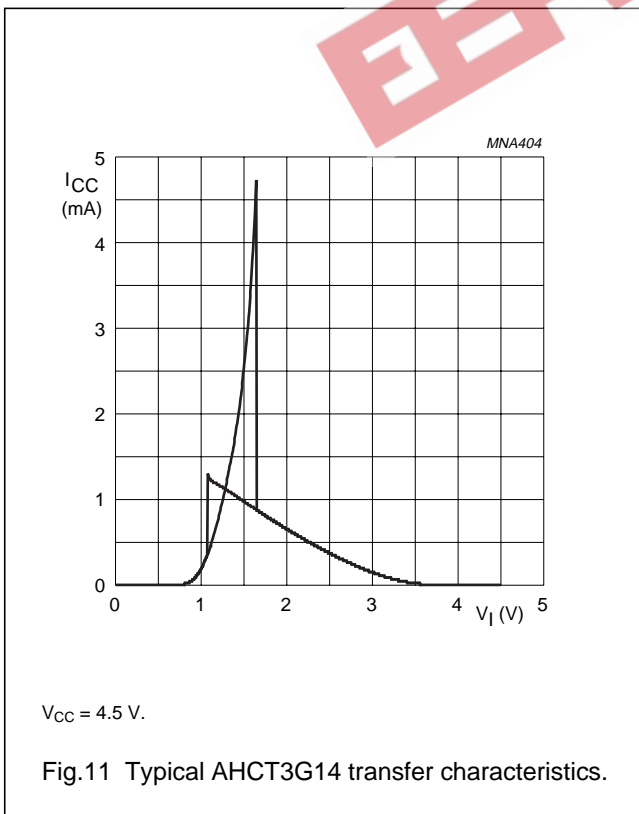
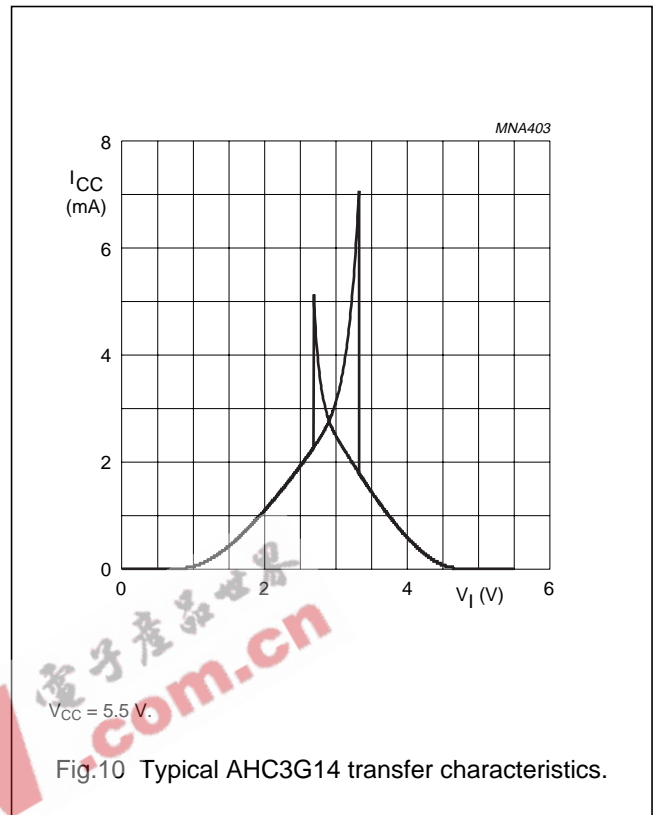
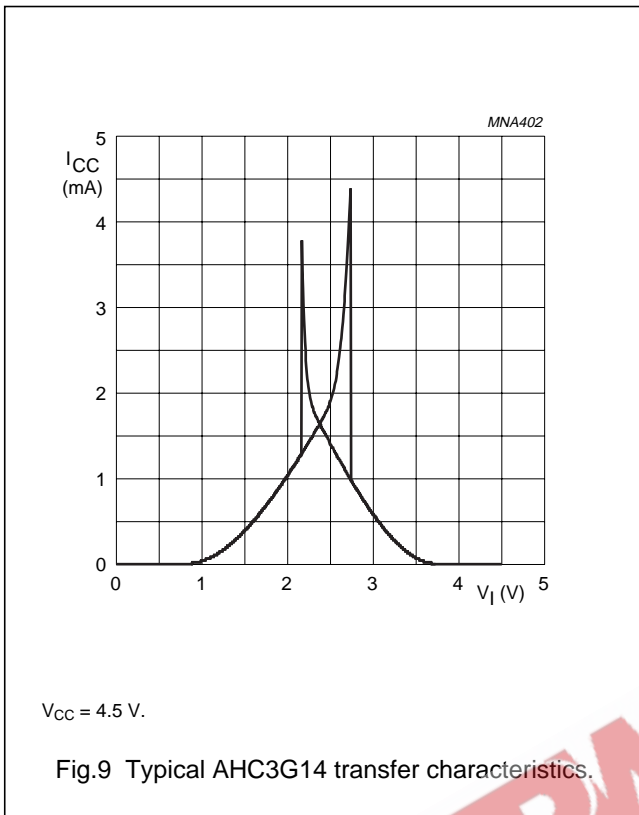

Inverting Schmitt trigger

74AHC3G14; 74AHCT3G14

AC CHARACTERISTICS

Type 74AHC3G14

GND = 0 V; $t_r = t_f \leq 3.0$ ns.

| SYMBOL | PARAMETER | TEST CONDITIONS | | | MIN. | TYP. | MAX. | UNIT |
|--|----------------------------|--------------------|---------------------|---------------------|------|------|------|------|
| | | WAVEFORMS | V _{CC} (V) | C _L (pF) | | | | |
| T_{amb} = 25 °C | | | | | | | | |
| t _{PHL} /t _{PLH} | propagation delay nA to nY | see Figs 13 and 14 | 3.3 | 15 | – | 4.2 | – | ns |
| | | | | 50 | – | 6.0 | – | ns |
| | | | 3.0 to 3.6 | 15 | – | – | 12.8 | ns |
| | | | | 50 | – | – | 16.3 | ns |
| | | | 5.0 | 15 | – | 3.2 | – | ns |
| | | | | 50 | – | 4.6 | – | ns |
| | | | 4.5 to 5.5 | 15 | – | – | 8.6 | ns |
| | | | | 50 | – | – | 10.6 | ns |
| T_{amb} = –40 °C to +85 °C | | | | | | | | |
| t _{PHL} /t _{PLH} | propagation delay nA to nY | see Figs 13 and 14 | 3.0 to 3.6 | 15 | 1.0 | – | 15.0 | ns |
| | | | | 50 | 1.0 | – | 18.5 | ns |
| | | | 4.5 to 5.5 | 15 | 1.0 | – | 10.0 | ns |
| | | | | 50 | 1.0 | – | 12.0 | ns |
| T_{amb} = –40 °C to +125 °C | | | | | | | | |
| t _{PHL} /t _{PLH} | propagation delay nA to nY | see Figs 13 and 14 | 3.0 to 3.6 | 15 | 1.0 | – | 16.5 | ns |
| | | | | 50 | 1.0 | – | 20.5 | ns |
| | | | 4.5 to 5.5 | 15 | 1.0 | – | 11.0 | ns |
| | | | | 50 | 1.0 | – | 13.5 | ns |

Inverting Schmitt trigger

74AHC3G14; 74AHCT3G14

Type 74AHCT3G14

GND = 0 V; $t_r = t_f \leq 3.0$ ns.

| SYMBOL | PARAMETER | TEST CONDITIONS | | | MIN. | TYP. | MAX. | UNIT |
|--|----------------------------|--------------------|---------------------|---------------------|------|------|------|------|
| | | WAVEFORMS | V _{CC} (V) | C _L (pF) | | | | |
| T_{amb} = 25 °C | | | | | | | | |
| t _{PHL} /t _{PLH} | propagation delay nA to nY | see Figs 13 and 14 | 5 | 15 | – | 4.1 | – | ns |
| | | | | 50 | – | 5.9 | – | ns |
| | | | 4.5 to 5.5 | 15 | – | – | 7.0 | ns |
| | | | | 50 | – | – | 8.5 | ns |
| T_{amb} = –40 °C to +85 °C | | | | | | | | |
| t _{PHL} /t _{PLH} | propagation delay nA to nY | see Figs 13 and 14 | 4.5 to 5.5 | 15 | 1.0 | – | 8.0 | ns |
| | | | | 50 | 1.0 | – | 10.0 | ns |
| T_{amb} = –40 °C to +125 °C | | | | | | | | |
| t _{PHL} /t _{PLH} | propagation delay nA to nY | see Figs 13 and 14 | 4.5 to 5.5 | 15 | 1.0 | – | 9.0 | ns |
| | | | | 50 | 1.0 | – | 11.0 | ns |

EEPW.com.cn 电子产业网

Inverting Schmitt trigger

74AHC3G14; 74AHCT3G14

AC WAVEFORMS

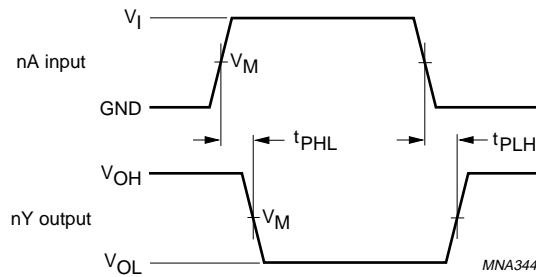

| FAMILY | V _I INPUT REQUIREMENTS | V _M INPUT | V _M OUTPUT |
|--------|-----------------------------------|----------------------|-----------------------|
| AHC3G | GND to V _{CC} | 50 % V _{CC} | 50 % V _{CC} |
| AHCT3G | GND to 3.0 V | 1.5 V | 50 % V _{CC} |

Fig.13 The input (nA) to output (nY) propagation delays.

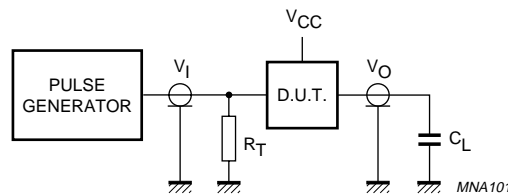

Definitions for test circuit:

C_L = Load capacitance including jig and probe capacitance. (See Chapter "AC characteristics" for values).

R_T = Termination resistance should be equal to the output impedance Z_o of the pulse generator.

Fig.14 Load circuitry for switching times.

Inverting Schmitt trigger

74AHC3G14; 74AHCT3G14

APPLICATION INFORMATION

The slow input rise and fall times cause additional power dissipation. This can be calculated using the following formula:

$$P_{ad} = f_i \times (t_r \times I_{CC(AV)} + t_f \times I_{CC(AV)}) \times V_{CC}$$

Where:

P_{ad} = additional power dissipation (μW);

f_i = input frequency (MHz);

t_r = input rise time (ns); 10 % to 90 %;

t_f = input fall time (ns); 90 % to 10 %;

$I_{CC(AV)}$ = average additional supply current (μA).

Average I_{CC} differs with positive or negative input transitions, as shown in Figs 15 and 16.

For AHC3G/AHCT3G14 used in relaxation oscillator circuit, see Fig.17.

Remark to the application information

All values given are typical unless otherwise specified.

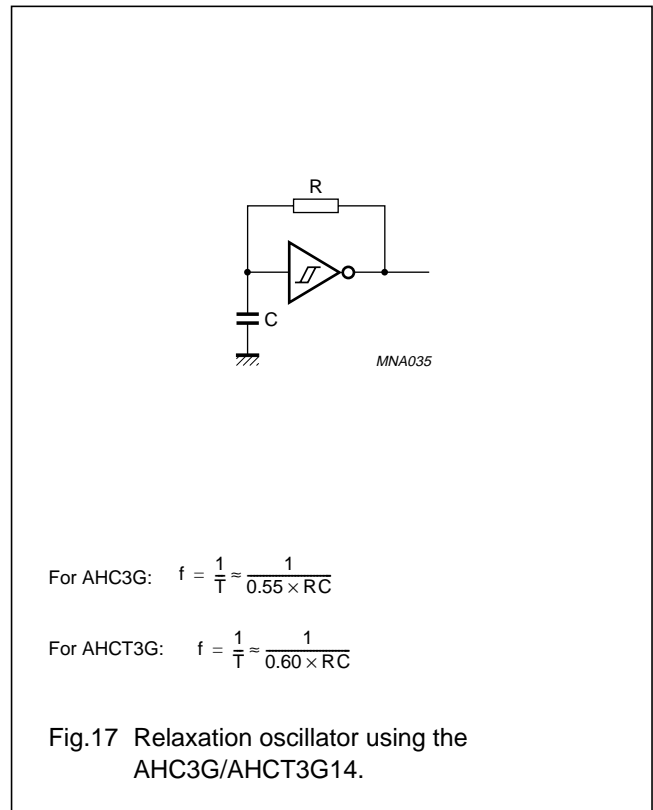
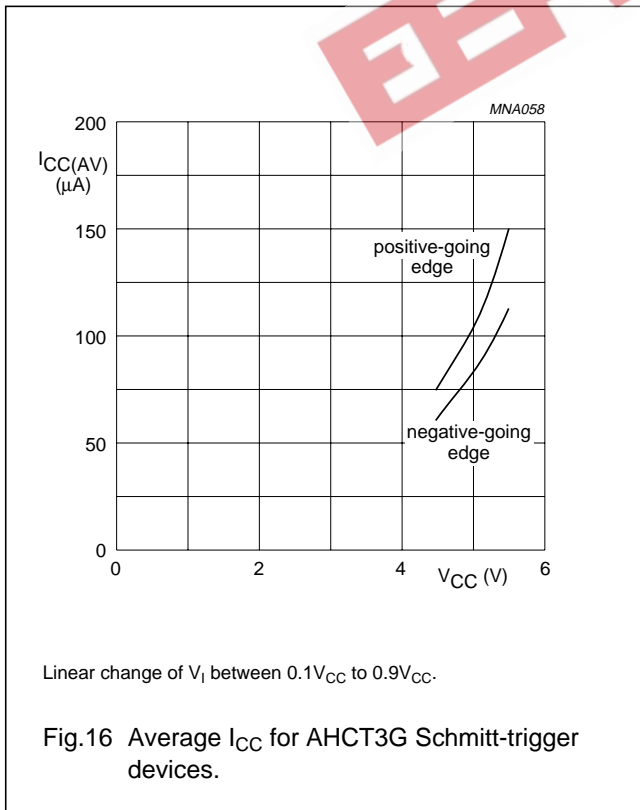
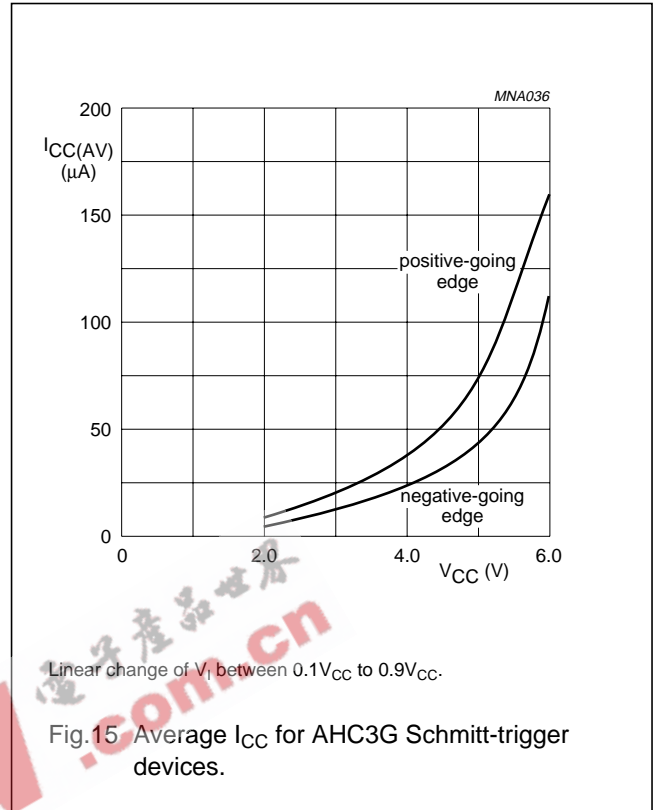

Inverting Schmitt trigger

74AHC3G14; 74AHCT3G14

PACKAGE OUTLINES

TSSOP8: plastic thin shrink small outline package; 8 leads; body width 3 mm; lead length 0.5 mm SOT505-2

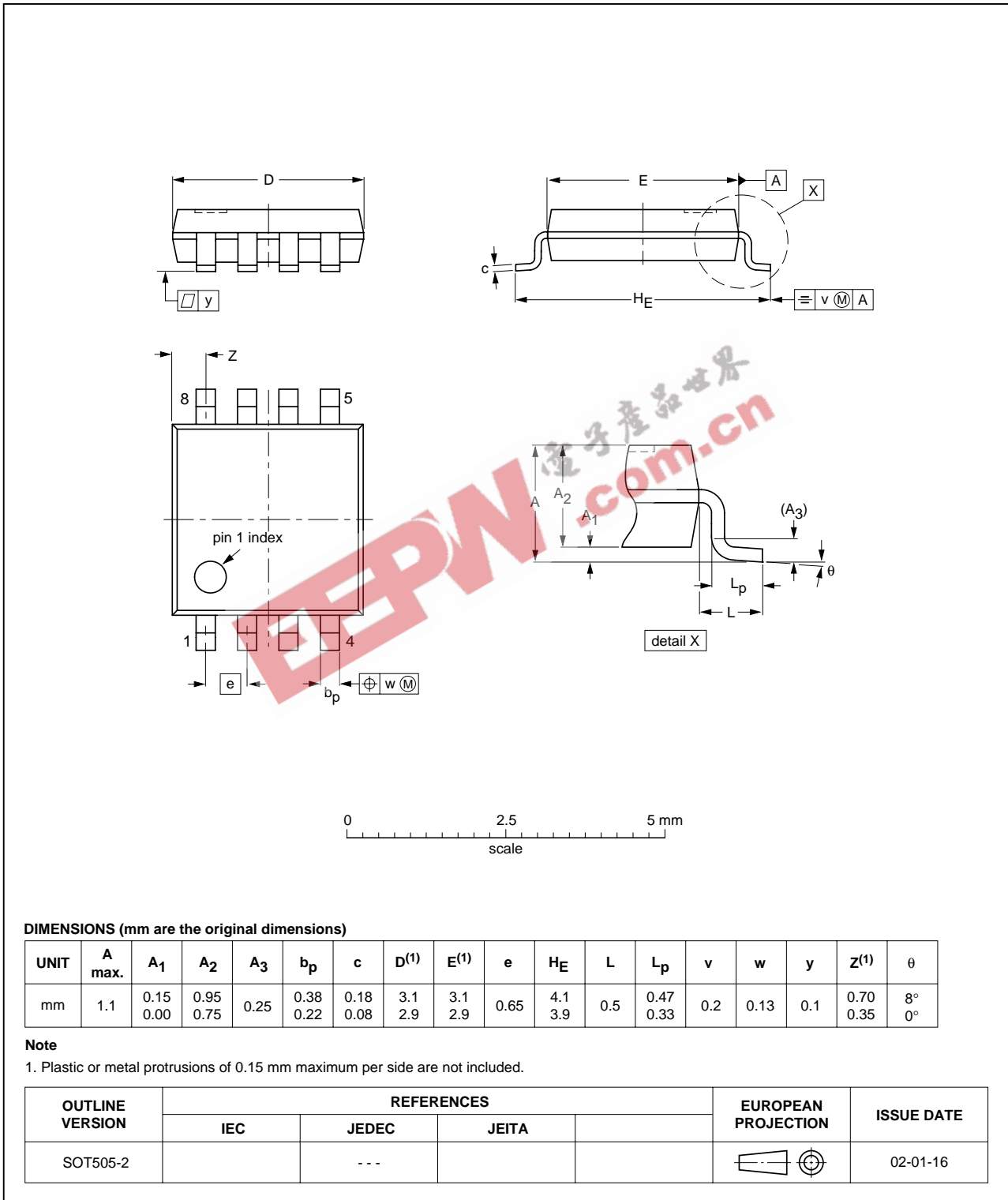

Inverting Schmitt trigger

74AHC3G14; 74AHCT3G14

VSSOP8: plastic very thin shrink small outline package; 8 leads; body width 2.3 mm

SOT765-1

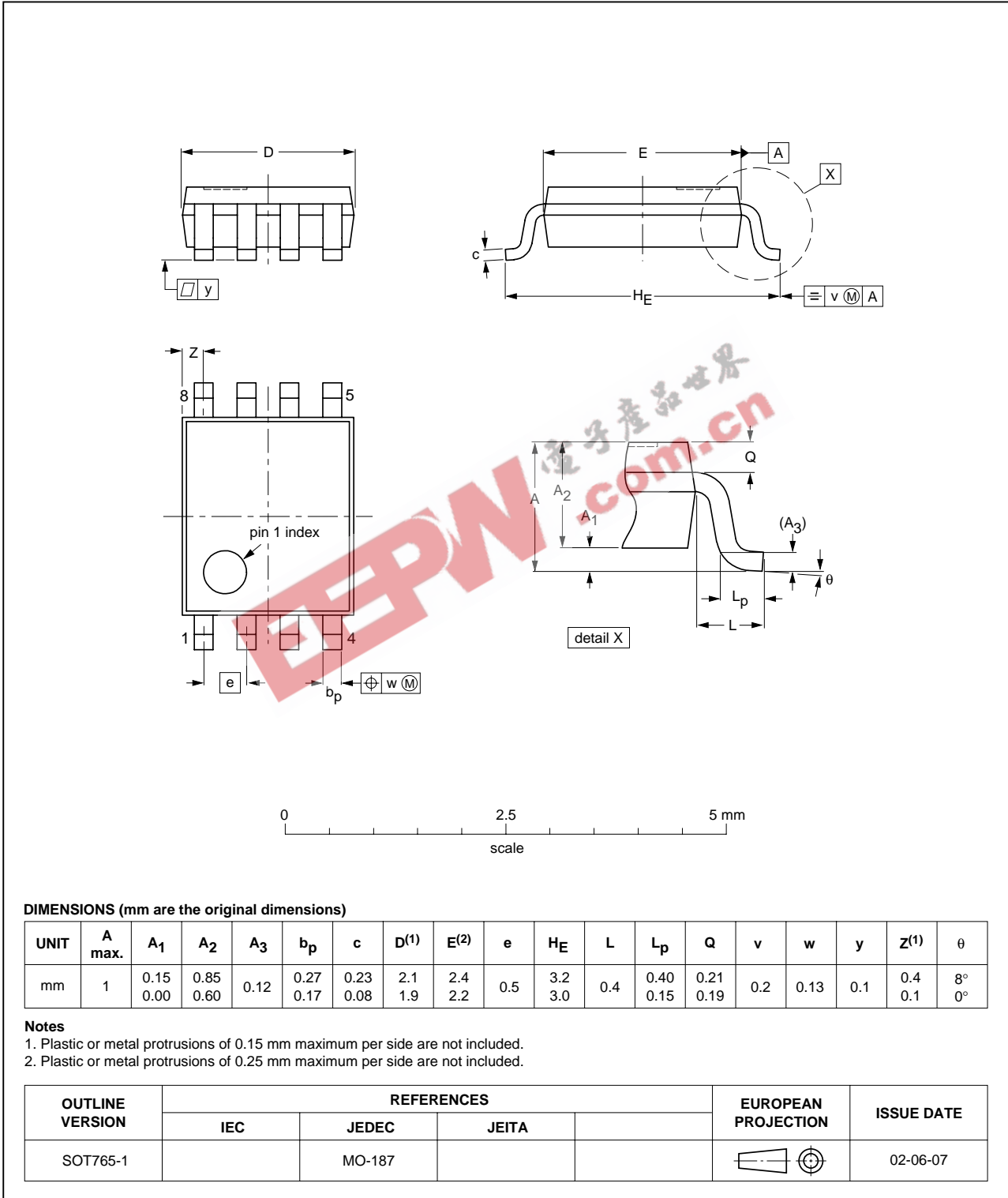

Inverting Schmitt trigger

74AHC3G14; 74AHCT3G14

XSON8: plastic extremely thin small outline package; no leads; 8 terminals; body 0.95 x 1.95 x 0.5 mm

SOT833-1

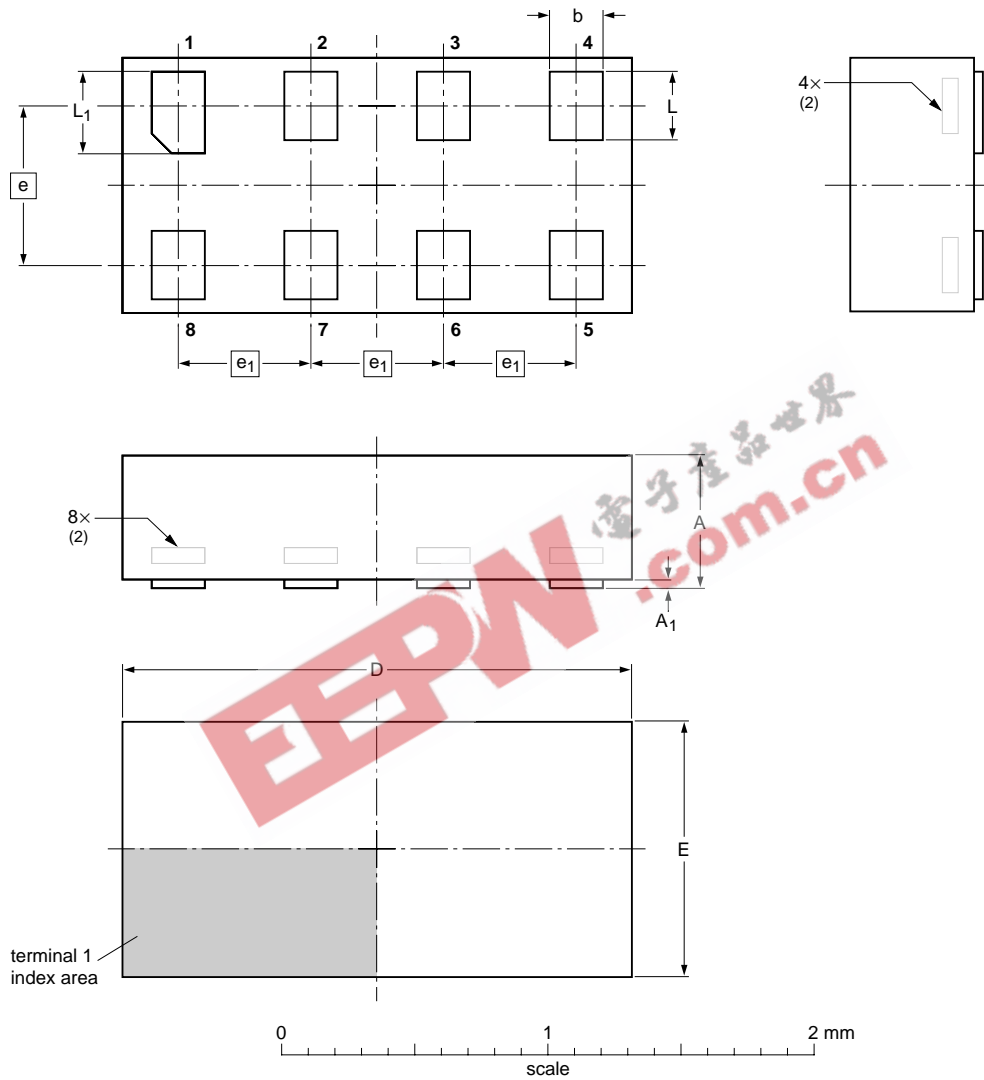

DIMENSIONS (mm are the original dimensions)

| UNIT | A ⁽¹⁾ max | A ₁ max | b | D | E | e | e ₁ | L | L ₁ |
|------|-------------------------|-----------------------|--------------|------------|------------|-----|----------------|--------------|----------------|
| mm | 0.5 | 0.04 | 0.25 0.17 | 2.0 1.9 | 1.0 0.9 | 0.6 | 0.5 | 0.35 0.27 | 0.40 0.32 |

Notes

- Including plating thickness.
- Can be visible in some manufacturing processes.

| OUTLINE VERSION | REFERENCES | | | EUROPEAN PROJECTION | ISSUE DATE |
|-----------------|------------|--------|-------|---------------------|----------------------|
| | IEC | JEDEC | JEITA | | |
| SOT833-1 | --- | MO-252 | --- | | 04-07-15 04-07-22 |

Inverting Schmitt trigger

74AHC3G14; 74AHCT3G14

DATA SHEET STATUS

| LEVEL | DATA SHEET STATUS ⁽¹⁾ | PRODUCT STATUS ⁽²⁾⁽³⁾ | DEFINITION |
|-------|----------------------------------|----------------------------------|--|
| I | Objective data | Development | This data sheet contains data from the objective specification for product development. Philips Semiconductors reserves the right to change the specification in any manner without notice. |
| II | Preliminary data | Qualification | This data sheet contains data from the preliminary specification. Supplementary data will be published at a later date. Philips Semiconductors reserves the right to change the specification without notice, in order to improve the design and supply the best possible product. |
| III | Product data | Production | This data sheet contains data from the product specification. Philips Semiconductors reserves the right to make changes at any time in order to improve the design, manufacturing and supply. Relevant changes will be communicated via a Customer Product/Process Change Notification (CPCN). |

Notes

1. Please consult the most recently issued data sheet before initiating or completing a design.
2. The product status of the device(s) described in this data sheet may have changed since this data sheet was published. The latest information is available on the Internet at URL <http://www.semiconductors.philips.com>.
3. For data sheets describing multiple type numbers, the highest-level product status determines the data sheet status.

DEFINITIONS

Short-form specification — The data in a short-form specification is extracted from a full data sheet with the same type number and title. For detailed information see the relevant data sheet or data handbook.

Limiting values definition — Limiting values given are in accordance with the Absolute Maximum Rating System (IEC 60134). Stress above one or more of the limiting values may cause permanent damage to the device. These are stress ratings only and operation of the device at these or at any other conditions above those given in the Characteristics sections of the specification is not implied. Exposure to limiting values for extended periods may affect device reliability.

Application information — Applications that are described herein for any of these products are for illustrative purposes only. Philips Semiconductors make no representation or warranty that such applications will be suitable for the specified use without further testing or modification.

DISCLAIMERS

Life support applications — These products are not designed for use in life support appliances, devices, or systems where malfunction of these products can reasonably be expected to result in personal injury. Philips Semiconductors customers using or selling these products for use in such applications do so at their own risk and agree to fully indemnify Philips Semiconductors for any damages resulting from such application.

Right to make changes — Philips Semiconductors reserves the right to make changes in the products - including circuits, standard cells, and/or software - described or contained herein in order to improve design and/or performance. When the product is in full production (status 'Production'), relevant changes will be communicated via a Customer Product/Process Change Notification (CPCN). Philips Semiconductors assumes no responsibility or liability for the use of any of these products, conveys no licence or title under any patent, copyright, or mask work right to these products, and makes no representations or warranties that these products are free from patent, copyright, or mask work right infringement, unless otherwise specified.

Philips Semiconductors – a worldwide company

Contact information

For additional information please visit <http://www.semiconductors.philips.com>. Fax: +31 40 27 24825
For sales offices addresses send e-mail to: sales.addresses@www.semiconductors.philips.com.

EEPW.com.cn 电子世界

© Koninklijke Philips Electronics N.V. 2004

SCA76

All rights are reserved. Reproduction in whole or in part is prohibited without the prior written consent of the copyright owner.

The information presented in this document does not form part of any quotation or contract, is believed to be accurate and reliable and may be changed without notice. No liability will be accepted by the publisher for any consequence of its use. Publication thereof does not convey nor imply any license under patent- or other industrial or intellectual property rights.

Printed in The Netherlands

R44/02/pp21

Date of release: 2004 Oct 18

Document order number: 9397 750 13741

Let's make things better.

**Philips
Semiconductors**



PHILIPS