

74LVX273

Low Voltage Octal D-Type Flip-Flop

General Description

The LVX273 has eight edge-triggered D-type flip-flops with individual D inputs and Q outputs. The common buffered Clock (CP) and Master Reset (\overline{MR}) input load and reset (clear) all flip-flops simultaneously.

The register is fully edge-triggered. The state of each D input, one setup time before the LOW-to-HIGH clock transition, is transferred to the corresponding flip-flop's Q output.

All outputs will be forced LOW independently of Clock or Data inputs by a LOW voltage level on the MR input. The device is useful for applications where the true output only is required and the Clock and Master Reset are common to all storage elements. The inputs tolerate up to 7V allowing interface of 5V systems to 3V systems.

Features

- Input voltage translation from 5V to 3V
- Ideal for low power/low noise 3.3V applications
- Guaranteed simultaneous switching noise level and dynamic threshold performance

Ordering Code:

Order Number	Package Number	Package Description
74LVX273M	M20B	20-Lead Small Outline Integrated Circuit (SOIC), JEDEC MS-013, 0.300" Wide
74LVX273SJ	M20D	Pb-Free 20-Lead Small Outline Package (SOP), EIAJ TYPE II, 5.3mm Wide
74LVX273MTC	MTC20	20-Lead Thin Shrink Small Outline Package (TSSOP), JEDEC MO-153, 4.4mm Wide

Devices also available in Tape and Reel. Specify by appending letter suffix "X" to the ordering code.
Pb-Free package per JEDEC J-STD-020B.

Logic Symbols

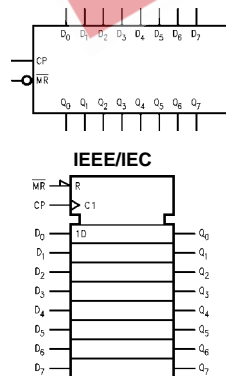

Connection Diagram

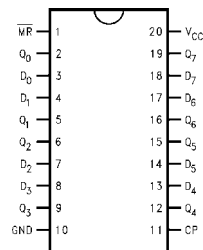

Pin Descriptions

Pin Names	Description
D ₀ -D ₇	Data Inputs
\overline{MR}	Master Reset
CP	Clock Pulse Input
Q ₀ -Q ₇	Data Outputs

Truth Table

Operating Mode	Inputs			Outputs
	\overline{MR}	CP	D _n	Q _n
Reset (Clear)	L	X	X	L
Load '1'	H	↗	H	H
Load '0'	H	↗	L	L

H = HIGH Voltage Level
L = LOW Voltage Level
X = Immaterial
↗ = LOW-to-HIGH Transition

74LVX273

Logic Diagram

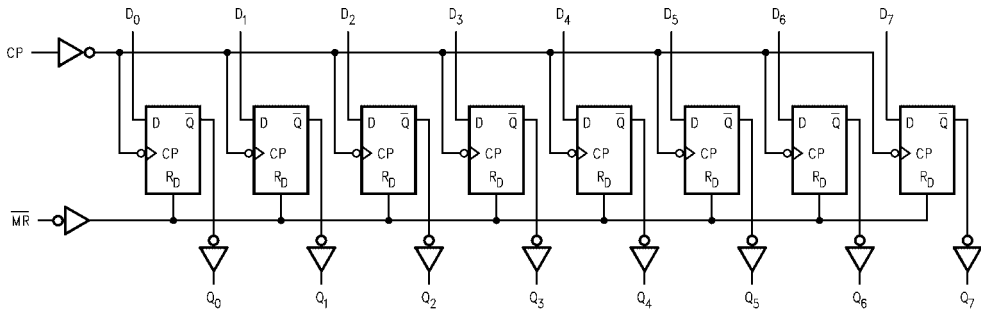

Please note that this diagram is provided only for the understanding of logic operations and should not be used to estimate propagation delays.



Absolute Maximum Ratings (Note 1)

Supply Voltage (V_{CC})	-0.5V to +7.0V
DC Input Diode Current (I_{IK})	
$V_I = -0.5V$	-20 mA
DC Input Voltage (V_I)	-0.5V to 7V
DC Output Diode Current (I_{OK})	
$V_O = -0.5V$	-20 mA
$V_O = V_{CC} + 0.5V$	+20 mA
DC Output Voltage (V_O)	-0.5V to $V_{CC} + 0.5V$
DC Output Source or Sink Current (I_O)	± 25 mA
DC V_{CC} or Ground Current (I_{CC} or I_{GND})	± 75 mA
Storage Temperature (T_{STG})	-65°C to +150°C
Power Dissipation	180 mW

Recommended Operating Conditions (Note 2)

Supply Voltage (V_{CC})	2.0V to 3.6V
Input Voltage (V_I)	0V to 5.5V
Output Voltage (V_O)	0V to V_{CC}
Operating Temperature (T_A)	-40°C to +85°C
Input Rise and Fall Time ($\Delta t/\Delta V$)	0 ns/V to 100 ns/V

Note 1: The "Absolute Maximum Ratings" are those values beyond which the safety of the device cannot be guaranteed. The device should not be operated at these limits. The parametric values defined in the Electrical Characteristics tables are not guaranteed at the absolute maximum ratings. The "Recommended Operating Conditions" table will define the conditions for actual device operation.

Note 2: Unused inputs must be held HIGH or LOW. They may not float.

DC Electrical Characteristics

Symbol	Parameter	V_{CC}	$T_A = +25^\circ\text{C}$			$T_A = -40^\circ\text{C to } +85^\circ\text{C}$		Units	Conditions
			Min	Typ	Max	Min	Max		
V_{IH}	HIGH Level Input Voltage	2.0	1.5			1.5	V		
		3.0	2.0			2.0			
		3.6	2.4			2.4			
V_{IL}	LOW Level Input Voltage	2.0		0.5		0.5	V		
		3.0		0.8		0.8			
		3.6		0.8		0.8			
V_{OH}	HIGH Level Output Voltage	2.0	1.9	2.0		1.9	V	$V_{IN} = V_{IH}$ or V_{IL} $I_{OH} = -50 \mu\text{A}$ $I_{OH} = -50 \mu\text{A}$ $I_{OH} = -4 \text{mA}$	
		3.0	2.9	3.0		2.9			
		3.0	2.58			2.48			
V_{OL}	LOW Level Output Voltage	2.0		0.0	0.1		V	$V_{IN} = V_{IH}$ or V_{IL} $I_{OL} = 50 \mu\text{A}$ $I_{OL} = 50 \mu\text{A}$ $I_{OL} = 4 \text{mA}$	
		3.0		0.0	0.1				
		3.0		0.36	0.44				
I_{OZ}	3-STATE Output Off-State Current	3.6		± 0.25		± 2.5	μA	$V_{IN} = V_{IH}$ or V_{IL} $V_{OUT} = V_{CC}$ or GND	
I_{IN}	Input Leakage Current	3.6			± 0.1	± 1.0	μA	$V_{IN} = 5.5V$ or GND	
I_{CC}	Quiescent Supply Current	3.6			4.0	40.0	μA	$V_{IN} = V_{CC}$ or GND	

Noise Characteristics (Note 3)

Symbol	Parameter	V_{CC} (V)	$T_A = 25^\circ\text{C}$		Units	C_L (pF)
			Typ	Limit		
V_{OLP}	Quiet Output Maximum Dynamic V_{OL}	3.3	0.5	0.8	V	50
V_{OLV}	Quiet Output Minimum Dynamic V_{OL}	3.3	-0.5	-0.8	V	50
V_{IHD}	Minimum HIGH Level Dynamic Input Voltage	3.3		2.0	V	50
V_{ILD}	Maximum LOW Level Dynamic Input Voltage	3.3		0.8	V	50

Note 3: Input $t_r = t_f = 3\text{ns}$

AC Electrical Characteristics									
Symbol	Parameter	V _{CC} (V)	T _A = +25°C			T _A = -40°C to +85°C		Units	C _L (pF)
			Min	Typ	Max	Min	Max		
t _{PLH}	Propagation Delay Time CP to Q _n	2.7		9.0	16.9	1.0	20.5	ns	15
t _{PHL}				11.5	20.0	1.0	24.0		50
		3.3 ± 0.3		7.1	11.0	1.0	13.0		15
				9.6	14.5	1.0	16.5		50
t _{PHL}	Propagation Delay MR to Q _n	2.7		9.3	17.8	1.0	20.5	ns	15
				11.8	21.1	1.0	24.0		50
		3.3 ± 0.3		7.3	11.5	1.0	13.5		15
				9.8	15.0	1.0	17.0		50
t _S	Setup Time D _n to CP	2.7	8.0			9.5		ns	
		3.3 ± 0.3	5.5			6.5			
t _H	Hold Time D _n to CP	2.7	1.0			1.0		ns	
		3.3 ± 0.3	1.0			1.0			
t _{REC}	Removal Time MR to CP	2.7	4.0			4.0		ns	
		3.3 ± 0.3	2.5			2.5			
t _W	Clock Pulse Width	2.7	8.0			9.5		ns	
		3.3 ± 0.3	5.5			6.5			
t _W	MR Pulse Width	2.7	7.5			8.5		ns	
		3.3 ± 0.3	5.0			6.0			
f _{MAX}	Maximum Clock Frequency	2.7	55	110		45		MHz	15
			45	60		40			50
		3.3 ± 0.3	95	150		80			15
			60	90		50			50
t _{OSLH}	Output to Output	2.7			1.5		1.5	ns	50
t _{OSSL}	Skew (Note 4)	3.3			1.5		1.5		

Note 4: Parameter guaranteed by design. t_{OSLH} = |t_{PLHm} - t_{PLHn}|, t_{OSSL} = |t_{PHLm} - t_{PHLn}|

Capacitance

Symbol	Parameter	T _A = +25°C			T _A = -40°C to +85°C		Units
		Min	Typ	Max	Min	Max	
C _{IN}	Input Capacitance		4	10		10	pF
C _{OUT}	Output Capacitance		6				pF
C _{PD}	Power Dissipation Capacitance (Note 5)		31				pF

Note 5: C_{PD} is defined as the value of the internal equivalent capacitance which is calculated from the operating current consumption without load.

Average operating current can be obtained by the equation: $I_{CC(opr)} = \frac{C_{PD} \times V_{CC} \times f_{IN} + I_{CC}}{8}$ (per F/F)

Physical Dimensions inches (millimeters) unless otherwise noted



**20-Lead Small Outline Integrated Circuit (SOIC), JEDEC MS-013, 0.300" Wide
Package Number M20B**

Physical Dimensions inches (millimeters) unless otherwise noted (Continued)



LAND PATTERN RECOMMENDATION

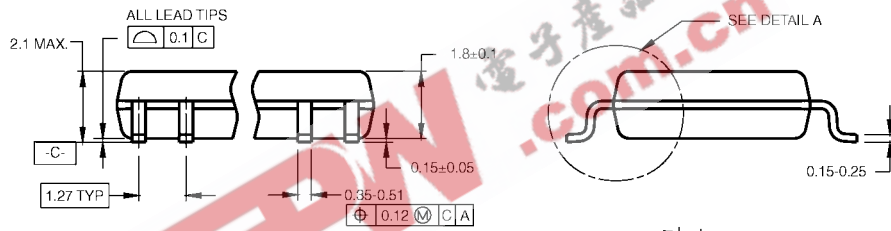

DIMENSIONS ARE IN MILLIMETERS

- NOTES:
- A. CONFORMS TO EIAJ EDR-7320 REGISTRATION, ESTABLISHED IN DECEMBER, 1996.
 - B. DIMENSIONS ARE IN MILLIMETERS.
 - C. DIMENSIONS ARE EXCLUSIVE OF BURRS, MOLD FLASH, AND TIE BAR EXTRUSIONS.

M20DRevB1

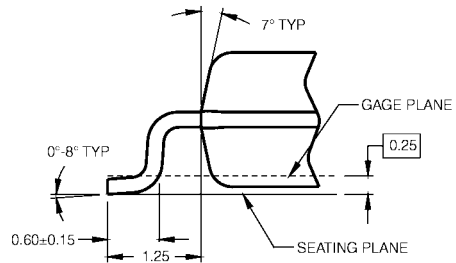

DETAIL A

**Pb-Free 20-Lead Small Outline Package (SOP), EIAJ TYPE II, 5.3mm Wide
Package Number M20D**

Physical Dimensions inches (millimeters) unless otherwise noted (Continued)

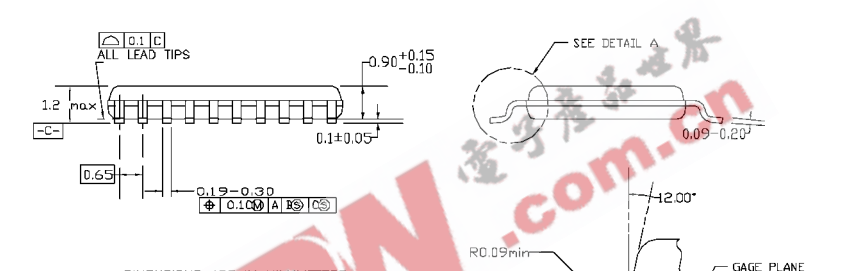
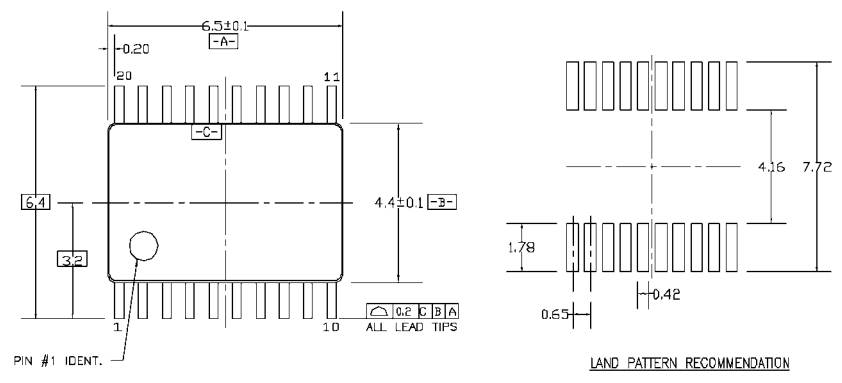

DIMENSIONS ARE IN MILLIMETERS

- NOTES:
- A. CONFORMS TO JEDEC REGISTRATION MO-153, VARIATION AC, REF NOTE 6, DATE 7/93.
 - B. DIMENSIONS ARE IN MILLIMETERS.
 - C. DIMENSIONS ARE EXCLUSIVE OF BURRS, MOLDS FLASH, AND THE LEAD EXTRUSIONS.
 - D. DIMENSIONS AND TOLERANCES PER ANSI Y14.5M, 1982.

MTC20REV D1

20-Lead Thin Shrink Small Outline Package (TSSOP), JEDEC MO-153, 4.4mm Wide Package Number MTC20

Fairchild does not assume any responsibility for use of any circuitry described, no circuit patent licenses are implied and Fairchild reserves the right at any time without notice to change said circuitry and specifications.

LIFE SUPPORT POLICY

FAIRCHILD'S PRODUCTS ARE NOT AUTHORIZED FOR USE AS CRITICAL COMPONENTS IN LIFE SUPPORT DEVICES OR SYSTEMS WITHOUT THE EXPRESS WRITTEN APPROVAL OF THE PRESIDENT OF FAIRCHILD SEMICONDUCTOR CORPORATION. As used herein:

1. Life support devices or systems are devices or systems which, (a) are intended for surgical implant into the body, or (b) support or sustain life, and (c) whose failure to perform when properly used in accordance with instructions for use provided in the labeling, can be reasonably expected to result in a significant injury to the user.
2. A critical component in any component of a life support device or system whose failure to perform can be reasonably expected to cause the failure of the life support device or system, or to affect its safety or effectiveness.

www.fairchildsemi.com