

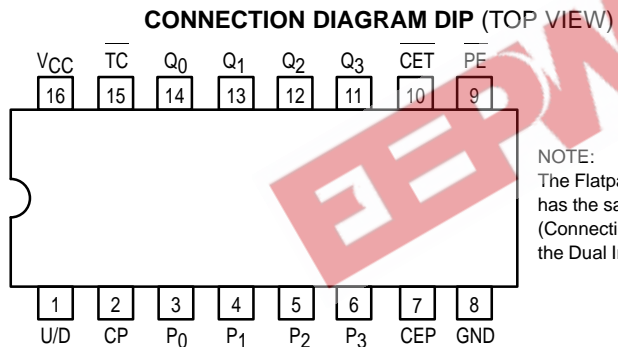

BCD DECADE/MODULO 16 BINARY SYNCHRONOUS BI-DIRECTIONAL COUNTERS

The SN54/74LS168 and SN54/74LS169 are fully synchronous 4-stage up/down counters featuring a preset capability for programmable operation, carry lookahead for easy cascading and a U/D input to control the direction of counting. The SN54/74LS168 counts in a BCD decade (8, 4, 2, 1) sequence, while the SN54/74LS169 operates in a Modulo 16 binary sequence. All state changes, whether in counting or parallel loading, are initiated by the LOW-to-HIGH transition of the clock.

- Low Power Dissipation 100 mW Typical
- High-Speed Count Frequency 30 MHz Typical
- Fully Synchronous Operation
- Full Carry Lookahead for Easy Cascading
- Single Up/Down Control Input
- Positive Edge-Trigger Operation
- Input Clamp Diodes Limit High-Speed Termination Effects



NOTE:
The Flatpak version has the same pinouts (Connection Diagram) as the Dual In-Line Package.

PIN NAMES

<u>CEP</u>	Count Enable Parallel (Active LOW) Input
<u>CET</u>	Count Enable Trickle (Active LOW) Input
<u>CP</u>	Clock Pulse (Active positive going edge) Input
<u>PE</u>	Parallel Enable (Active LOW) Input
U/D	Up-Down Count Control Input
P ₀ -P ₃	Parallel Data Inputs
Q ₀ -Q ₃	Flip-Flop Outputs
TC	Terminal Count (Active LOW) Output

NOTES:

- 1 TTL Unit Load (U.L.) = 40 μ A HIGH/1.6 mA LOW.
- The Output LOW drive factor is 2.5 U.L. for Military (54) and 5 U.L. for Commercial (74) Temperature Ranges.

LOADING (Note a)

	HIGH	LOW
<u>CEP</u>	0.5 U.L.	0.25 U.L.
<u>CET</u>	1.0 U.L.	0.5 U.L.
<u>CP</u>	0.5 U.L.	0.25 U.L.
<u>PE</u>	0.5 U.L.	0.25 U.L.
U/D	0.5 U.L.	0.25 U.L.
P ₀ -P ₃	0.5 U.L.	0.25 U.L.
Q ₀ -Q ₃	10 U.L.	5 (2.5) U.L.
TC	10 U.L.	5 (2.5) U.L.

**SN54/74LS168
SN54/74LS169**

**BCD DECADE/MODULO
16 BINARY SYNCHRONOUS
BI-DIRECTIONAL COUNTERS**

LOW POWER SCHOTTKY

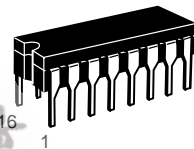

**J SUFFIX
CERAMIC
CASE 620-09**

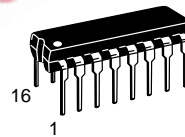

**N SUFFIX
PLASTIC
CASE 648-08**

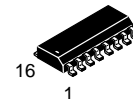

**D SUFFIX
SOIC
CASE 751B-03**

ORDERING INFORMATION

SN54LSXXXJ	Ceramic
SN74LSXXXN	Plastic
SN74LSXXXD	SOIC

LOGIC SYMBOL

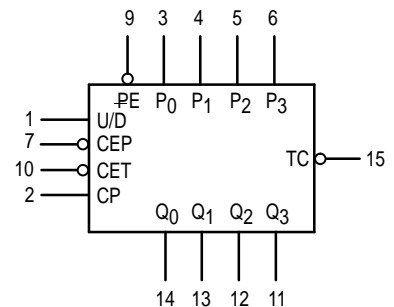

V_{CC} = PIN 16
GND = PIN 8

SN54/74LS168 • SN54/74LS169

STATE DIAGRAMS

SN54/74LS168
UP/DOWN DECADE COUNTER

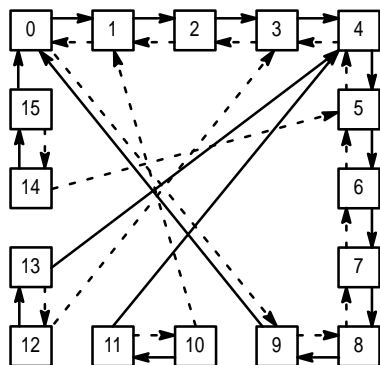

SN54/74LS168

UP: $TC = \overline{Q_0} \cdot \overline{Q_3} \cdot (U/D)$
 DOWN: $TC = Q_0 \cdot Q_1 \cdot Q_2 \cdot Q_3 \cdot (U/D)$

SN54/74LS169

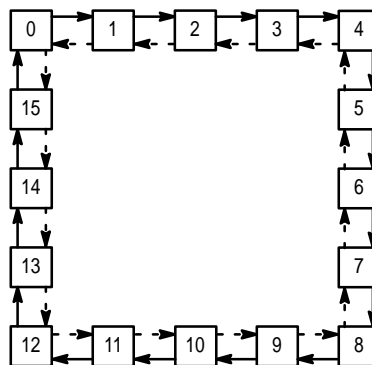

SN54/74LS169

UP: $TC = \overline{Q_0} \cdot \overline{Q_1} \cdot \overline{Q_2} \cdot \overline{Q_3} \cdot (U/D)$
 DOWN: $TC = Q_0 \cdot Q_1 \cdot Q_2 \cdot Q_3 \cdot (U/D)$

LOGIC DIAGRAMS

SN54/74LS168

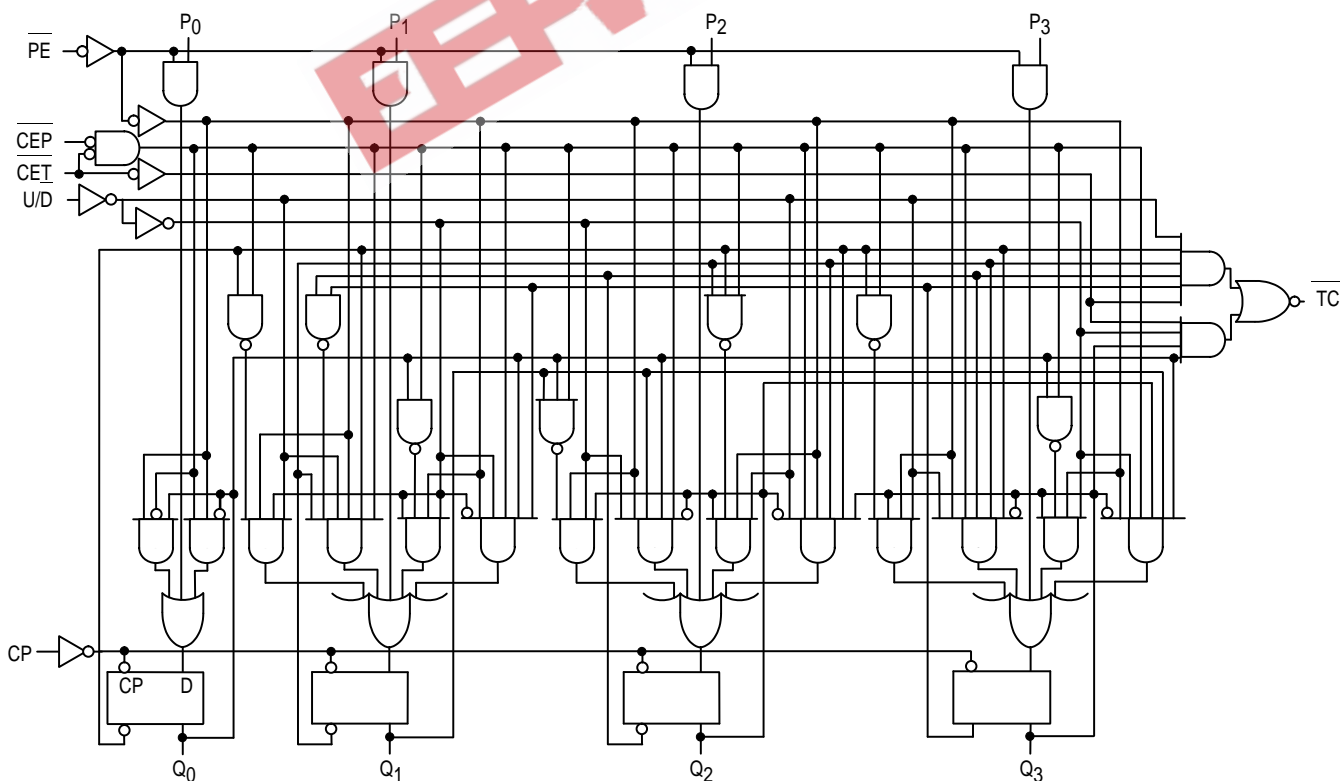

SN54/74LS168 • SN54/74LS169

LOGIC DIAGRAMS (continued)

SN54/74LS169

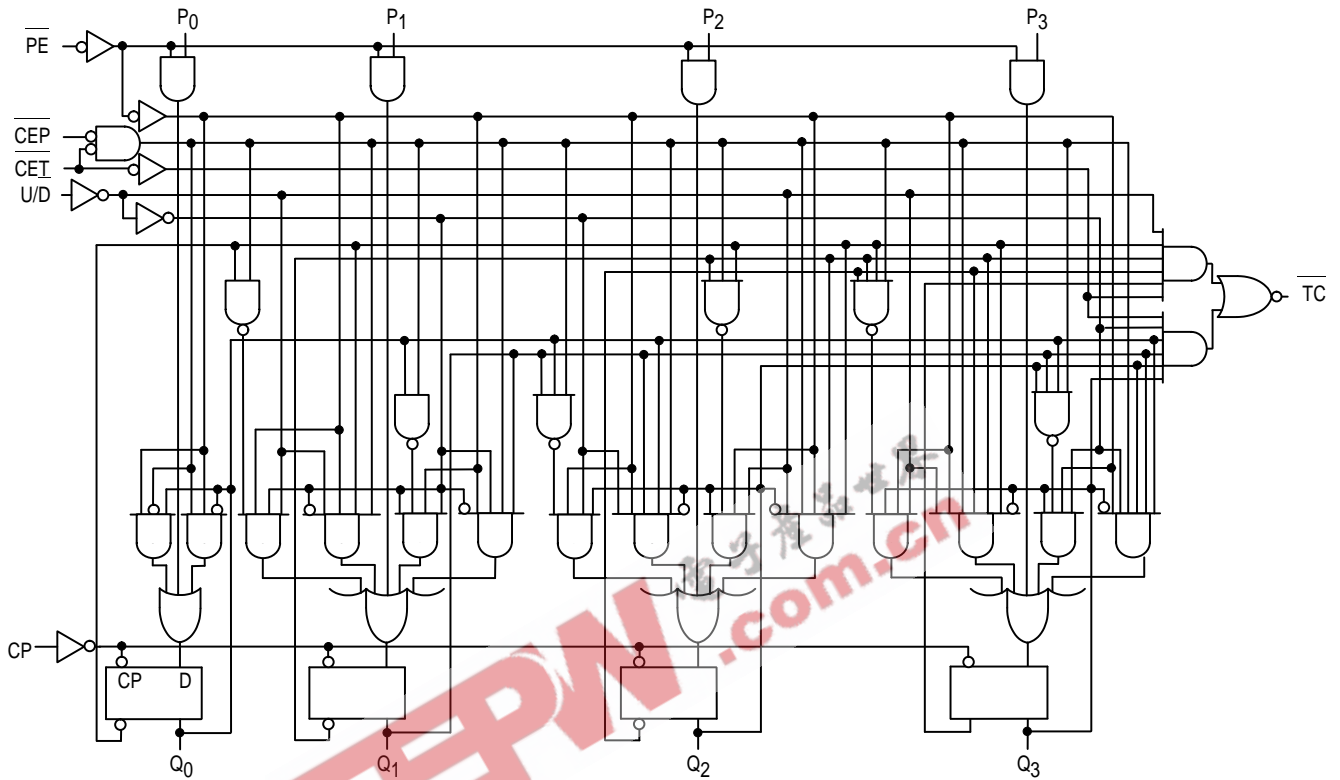

GUARANTEED OPERATING RANGES

Symbol	Parameter		Min	Typ	Max	Unit
V _{CC}	Supply Voltage	54	4.5	5.0	5.5	V
		74	4.75	5.0	5.25	
T _A	Operating Ambient Temperature Range	54	-55	25	125	°C
		74	0	25	70	
I _{OH}	Output Current — High	54, 74			-0.4	mA
I _{OL}	Output Current — Low	54			4.0	mA
		74			8.0	

SN54/74LS168 • SN54/74LS169

DC CHARACTERISTICS OVER OPERATING TEMPERATURE RANGE (unless otherwise specified)

Symbol	Parameter	Limits			Unit	Test Conditions	
		Min	Typ	Max			
V _{IH}	Input HIGH Voltage	2.0			V	Guaranteed Input HIGH Voltage for All Inputs	
V _{IL}	Input LOW Voltage	54		0.7	V	Guaranteed Input LOW Voltage for All Inputs	
		74		0.8			
V _{IK}	Input Clamp Diode Voltage		-0.65	-1.5	V	V _{CC} = MIN, I _{IN} = -18 mA	
V _{OH}	Output HIGH Voltage	54	2.5	3.5	V	V _{CC} = MIN, I _{OH} = MAX, V _{IN} = V _{IH} or V _{IL} per Truth Table	
		74	2.7	3.5	V		
V _{OL}	Output LOW Voltage	54, 74		0.25	0.4	V	I _{OL} = 4.0 mA V _{CC} = V _{CC} MIN, V _{IN} = V _{IL} or V _{IH} per Truth Table
		74		0.35	0.5	V	
I _{IH}	Input HIGH Current Other Inputs CET Input				20 40	μA	V _{CC} = MAX, V _{IN} = 2.7 V
	Other Input CET Input				0.1 0.2	mA	V _{CC} = MAX, V _{IN} = 7.0 V
I _{IL}	Input LOW Current Other Input CET Input				-0.4 -0.8	mA	V _{CC} = MAX, V _{IN} = 0.4 V
I _{OS}	Short Circuit Current (Note 1)	-20			-100	mA	V _{CC} = MAX
I _{CC}	Power Supply Current				34	mA	V _{CC} = MAX

Note 1: Not more than one output should be shorted at one time, nor for more than 1 second.

FUNCTIONAL DESCRIPTION

The SN54/74LS168 and SN54/74LS169 use edge-triggered D-type flip-flops that have no constraints on changing the control or data input signals in either state of the Clock. The only requirement is that the various inputs attain the desired state at least a set-up time before the rising edge of the clock and remain valid for the recommended hold time thereafter.

The parallel load operation takes precedence over the other operations, as indicated in the Mode Select Table. When PE is LOW, the data on the P₀-P₃ inputs enters the flip-flops on the next rising edge of the Clock. In order for counting to occur, both CEP and CET must be LOW and PE must be HIGH. The U/D input then determines the direction of counting.

The Terminal Count (TC) output is normally HIGH and goes LOW, provided that CET is LOW, when a counter reaches zero in the COUNT DOWN mode or reaches 15 (9 for the SN54/74LS168) in the COUNT UP mode. The TC output state is not a function of the Count Enable Parallel (CEP) input level. The TC output of the SN54/74LS168 decade counter can also be LOW in the illegal states 11, 13 and 15, which can occur when power is turned on or via parallel loading. If illegal state occurs, the SN54/74LS168 will return to the legitimate sequence within two counts. Since the TC signal is derived by decoding the flip-flop states, there exists the possibility of decoding spikes on TC. For this reason the use of TC as a clock signal is not recommended.

MODE SELECT TABLE

PE	CEP	CET	U/D	Action on Rising Clock Edge
L	X	X	X	Load (P _n → Q _n)
H	L	L	H	Count Up (increment)
H	L	L	L	Count Down (decrement)
H	H	X	X	No Change (Hold)
H	X	H	X	No Change (Hold)

H = HIGH Voltage Level
L = LOW Voltage Level
X = Immaterial

SN54/74LS168 • SN54/74LS169

AC CHARACTERISTICS (T_A = 25°C, V_{CC} = 5.0 V)

Symbol	Parameter	Limits			Unit	Test Conditions
		Min	Typ	Max		
f _{MAX}	Maximum Clock Frequency	25	32		MHz	V _{CC} = 5.0 V C _L = 15 pF
t _{PLH} t _{PHL}	Propagation Delay, Clock to TC		23 23	35 35	ns	
t _{PLH} t _{PHL}	Propagation Delay, Clock to any Q		13 15	20 23	ns	
t _{PLH} t _{PHL}	Propagation Delay, CET to TC		15 15	20 20	ns	
t _{PLH} t _{PHL}	Propagation Delay, U/D to TC		17 19	25 29	ns	

AC SETUP REQUIREMENTS (T_A = 25°C)

Symbol	Parameter	Limits			Unit	Test Conditions
		Min	Typ	Max		
t _W	Clock Pulse Width	25			ns	V _{CC} = 5.0 V
t _s	Setup Time, Data or Enable	20			ns	
t _s	Setup Time PE	25			ns	
t _s	Setup Time U/D	30			ns	
t _h	Hold Time Any Input	0			ns	

SN54/74LS168 • SN54/74LS169

AC WAVEFORMS

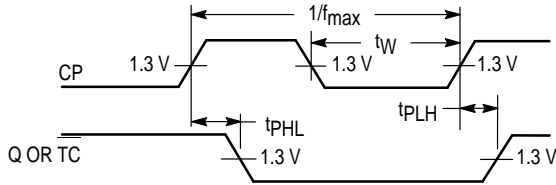

Figure 1. Clock to Output Delays, Count Frequency, and Clock Pulse Width

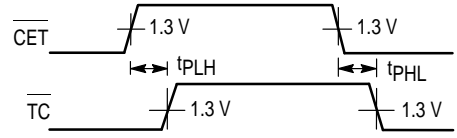

Figure 2. Count Enable Trickle Input To Terminal Count Output Delays

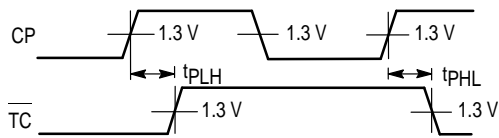

Figure 3. Clock to Terminal Delays

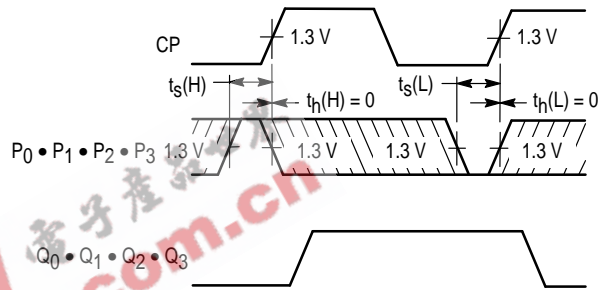
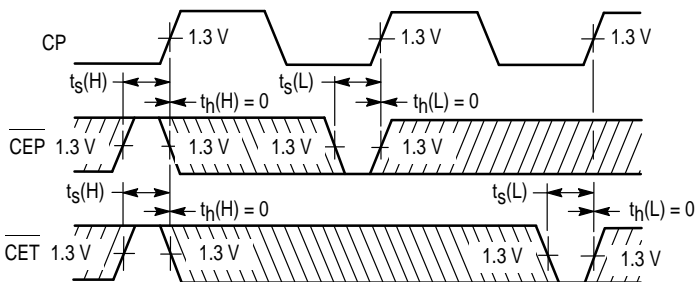
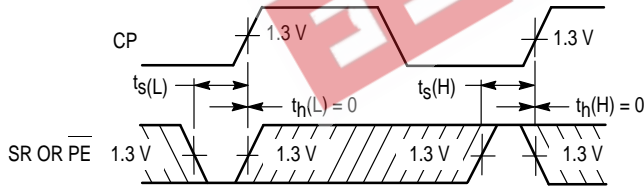

Figure 4. Setup Time (t_s) and Hold (t_h) for Parallel Data Inputs



The shaded areas indicate when the input is permitted to change for predictable output performance.

Figure 5. Setup Time and Hold Time for Count Enable and Parallel Enable Inputs, and Up-Down Control Inputs

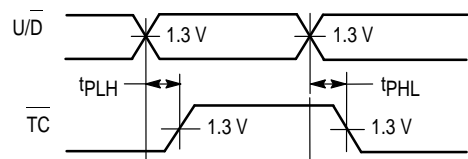

Figure 6. Up-Down Input to Terminal Count Output Delays