

74LCX74

Low Voltage Dual D-Type Positive Edge-Triggered Flip-Flop with 5V Tolerant Inputs

General Description

The LCX74 is a dual D-type flip-flop with Asynchronous Clear and Set inputs and complementary (Q, \bar{Q}) outputs. Information at the input is transferred to the outputs on the positive edge of the clock pulse. After the Clock Pulse input threshold voltage has been passed, the Data input is locked out and information present will not be transferred to the outputs until the next rising edge of the Clock Pulse input.

Asynchronous Inputs:

- LOW input to \bar{S}_D (Set) sets Q to HIGH level
- LOW input to \bar{C}_D (Clear) sets Q to LOW level
- Clear and Set are independent of clock
- Simultaneous LOW on \bar{C}_D and \bar{S}_D makes both Q and \bar{Q} HIGH

Features

- 5V tolerant inputs
- 2.3V–3.6V V_{CC} specifications provided
- 7.0 ns t_{PD} max ($V_{CC} = 3.3V$), 10 μA I_{CC} max
- Power down high impedance inputs and outputs
- ± 24 mA output drive ($V_{CC} = 3.0V$)
- Implements patented noise/EMI reduction circuitry
- Latch-up performance exceeds JEDEC 78 conditions
- ESD performance:
 - Human body model > 2000V
 - Machine model > 200V
- Leadless Pb-Free DQFN package

Ordering Code:

Order Number	Package Number	Package Description
74LCX74M	M14A	14-Lead Small Outline Integrated Circuit (SOIC), JEDEC MS-012, 0.150" Narrow
74LCX74MX_NL (Note 2)	M14A	Pb-Free 14-Lead Small Outline Integrated Circuit (SOIC), JEDEC MS-012, 0.150" Narrow
74LCX74SJ	M14D	Pb-Free 14-Lead Small Outline Package (SOP), EIAJ TYPE II, 5.3mm Wide
74LCX74BQX (Note 1)	MLP014A	Pb-Free 14-Terminal Depopulated Quad Very-Thin Flat Pack No Leads (DQFN), JEDEC MO-241, 2.5 x 3.0mm
74LCX74MTC	MTC14	14-Lead Thin Shrink Small Outline Package (TSSOP), JEDEC MO-153, 4.4mm Wide
74LCX74MTCX_NL (Note 2)	MTC14	Pb-Free 14-Lead Thin Shrink Small Outline Package (TSSOP), JEDEC MO-153, 4.4mm Wide

Devices also available in Tape and Reel. Specify by appending the suffix letter "X" to the ordering code.
Pb-Free package per JEDEC J-STD-020B.

Note 1: DQFN package available in Tape and Reel only.

Note 2: "_NL" indicates Pb-Free package (per JEDEC J-STD-020B). Device available in Tape and Reel only.

Logic Symbols

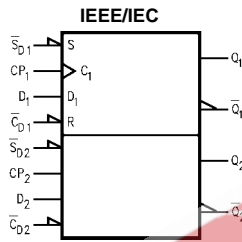
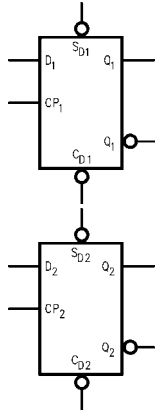

Connection Diagrams

Pin Assignments for SOIC, SOP, and TSSOP

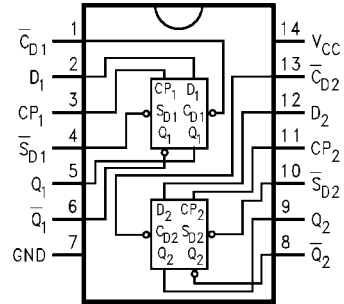

Pad Assignment for DQFN

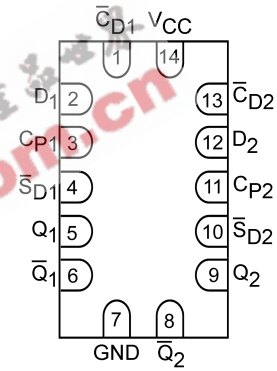

(Top View)

Pin Descriptions

Pin Names	Description
D ₁ , D ₂	Data Inputs
CP ₁ , CP ₂	Clock Pulse Inputs
\bar{C}_{D1} , \bar{C}_{D2}	Direct Clear Inputs
\bar{S}_{D1} , \bar{S}_{D2}	Direct Set Inputs
Q ₁ , \bar{Q}_1 , Q ₂ , \bar{Q}_2	Outputs

Truth Table

(Each Half)

Inputs				Outputs	
\bar{S}_D	\bar{C}_D	CP	D	Q	\bar{Q}
L	H	X	X	H	L
H	L	X	X	L	H
L	L	X	X	H	H
H	H	↗	H	H	L
H	H	↗	L	L	H
H	H	L	X	Q ₀	\bar{Q}_0

H = HIGH Voltage Level
 L = LOW Voltage Level
 X = Immaterial
 ↗ = LOW-to-HIGH Clock Transition
 Q₀(\bar{Q}_0) = Previous Q(\bar{Q}) before LOW-to-HIGH Transition of Clock

Absolute Maximum Ratings (Note 3)						
Symbol	Parameter	Value	Conditions	Units		
V_{CC}	Supply Voltage	-0.5 to +7.0		V		
V_I	DC Input Voltage	-0.5 to +7.0		V		
V_O	DC Output Voltage	-0.5 to $V_{CC} + 0.5$	Output in HIGH or LOW State (Note 4)	V		
I_{IK}	DC Input Diode Current	-50	$V_I < GND$	mA		
I_{OK}	DC Output Diode Current	-50	$V_O < GND$	mA		
		+50	$V_O > V_{CC}$	mA		
I_O	DC Output Source/Sink Current	± 50		mA		
I_{CC}	DC Supply Current per Supply Pin	± 100		mA		
I_{GND}	DC Ground Current per Ground Pin	± 100		mA		
T_{STG}	Storage Temperature	-65 to +150		°C		
Recommended Operating Conditions (Note 4)						
Symbol	Parameter	Min	Max	Units		
V_{CC}	Supply Voltage	Operating	2.0	3.6	V	
		Data Retention	1.5	3.6		
V_I	Input Voltage	0	5.5	V		
V_O	Output Voltage	0	V_{CC}	V		
I_{OH}/I_{OL}	Output Current	$V_{CC} = 3.0V - 3.6V$	± 24	mA		
		$V_{CC} = 2.7V - 3.0V$	± 12			
		$V_{CC} = 2.3V - 2.7V$	± 8			
T_A	Free-Air Operating Temperature	-40	85	°C		
$\Delta t/\Delta V$	Input Edge Rate, $V_{IN} = 0.8V - 2.0V$, $V_{CC} = 3.0V$	0	10	ns/V		
<p>Note 3: The Absolute Maximum Ratings are those values beyond which the safety of the device cannot be guaranteed. The device should not be operated at these limits. The parametric values defined in the Electrical Characteristics tables are not guaranteed at the Absolute Maximum Ratings. The "Recommended Operating Conditions" table will define the conditions for actual device operation.</p> <p>Note 4: I_O Absolute Maximum Rating must be observed.</p> <p>Note 5: Unused inputs must be held HIGH or LOW. They may not float.</p>						
DC Electrical Characteristics						
Symbol	Parameter	Conditions	V_{CC} (V)	$T_A = -40^\circ C$ to $+85^\circ C$		Units
				Min	Max	
V_{IH}	HIGH Level Input Voltage		2.3 - 2.7	1.7		V
			2.7 - 3.6	2.0		
V_{IL}	LOW Level Input Voltage		2.3 - 2.7		0.7	V
			2.3 - 3.6		0.8	
V_{OH}	HIGH Level Output Voltage	$I_{OH} = -100\mu A$	2.3 - 3.6	$V_{CC} - 0.2$		V
		$I_{OH} = -8\text{ mA}$	2.3	1.8		
		$I_{OH} = -12\text{ mA}$	2.7	2.2		
		$I_{OH} = -18\text{ mA}$	3.0	2.4		
		$I_{OH} = -24\text{ mA}$	3.0	2.2		
V_{OL}	LOW Level Output Voltage	$I_{OL} = 100\mu A$	2.3 - 3.6		0.2	V
		$I_{OL} = 8\text{ mA}$	2.3		0.6	
		$I_{OL} = 12\text{ mA}$	2.7		0.4	
		$I_{OL} = 16\text{ mA}$	3.0		0.4	
		$I_{OL} = 24\text{ mA}$	3.0		0.55	
I_I	Input Leakage Current	$0 \leq V_I \leq 5.5V$	2.3 - 3.6		± 5.0	μA
I_{OFF}	Power-Off Leakage Current	V_I or $V_O = 5.5V$	0		10	μA
I_{CC}	Quiescent Supply Current	$V_I = V_{CC}$ or GND	2.3 - 3.6		10	μA
		$3.6V \leq V_I \leq 5.5V$	2.3 - 3.6		± 10	
ΔI_{CC}	Increase in I_{CC} per Input	$V_{IH} = V_{CC} - 0.6V$	2.3 - 3.6		500	μA

AC Electrical Characteristics								
Symbol	Parameter	$T_A = -40^\circ\text{C to } +85^\circ\text{C}, R_L = 500\Omega$						Units
		$V_{CC} = 3.3V \pm 0.3V$		$V_{CC} = 2.7V$		$V_{CC} = 2.5V \pm 0.2V$		
		$C_L = 50\text{ pF}$		$C_L = 50\text{ pF}$		$C_L = 30\text{ pF}$		
		Min	Max	Min	Max	Min	Max	
t_{MAX}	Maximum Clock Frequency	150		150		150		MHz
t_{PHL}	Propagation Delay	1.5	7.0	1.5	8.0	1.5	8.4	ns
t_{PLH}	CP_n to Q_n or \bar{Q}_n	1.5	7.0	1.5	8.0	1.5	8.4	
t_{PHL}	Propagation Delay	1.5	7.0	1.5	8.0	1.5	8.4	ns
t_{PLH}	\bar{C}_{Dn} or \bar{S}_{Dn} to Q_n or \bar{Q}_n	1.5	7.0	1.5	8.0	1.5	8.4	
t_S	Setup Time	2.5		2.5		4.0		ns
t_H	Hold Time	1.5		1.5		2.0		ns
t_W	Pulse Width CP	3.3		3.3		4.0		ns
t_W	Pulse Width and \bar{C}_D, \bar{S}_D	3.3		3.6		4.0		ns
t_{REC}	Recovery Time	2.5		3.0		4.5		ns
t_{OSHL}	Output to Output Skew		1.0					ns
t_{OSLH}	(Note 6)		1.0					

Note 6: Skew is defined as the absolute value of the difference between the actual propagation delay for any two separate outputs of the same device. The specification applies to any outputs switching in the same direction, either HIGH-to-LOW (t_{OSHL}) or LOW-to-HIGH (t_{OSLH}).

Dynamic Switching Characteristics

Symbol	Parameter	Conditions	V_{CC} (V)	$T_A = 25^\circ\text{C}$		Unit
				Typical		
V_{OLP}	Quiet Output Dynamic Peak V_{OL}	$C_L = 50\text{ pF}, V_{IH} = 3.3V, V_{IL} = 0V$ $C_L = 30\text{ pF}, V_{IH} = 2.5V, V_{IL} = 0V$	3.3 2.5	0.8 0.6		V
V_{OLV}	Quiet Output Dynamic Peak V_{OL}	$C_L = 50\text{ pF}, V_{IH} = 3.3V, V_{IL} = 0V$ $C_L = 30\text{ pF}, V_{IH} = 2.5V, V_{IL} = 0V$	3.3 2.5	-0.8 -0.6		V

Capacitance

Symbol	Parameter	Conditions	Typical	Units
C_{IN}	Input Capacitance	$V_{CC} = \text{Open}, V_I = 0V \text{ or } V_{CC}$	7	pF
C_{OUT}	Output Capacitance	$V_{CC} = 3.3V, V_I = 0V \text{ or } V_{CC}$	8	pF
C_{PD}	Power Dissipation Capacitance	$V_{CC} = 3.3V, V_I = 0V \text{ or } V_{CC}, f = 10\text{ MHz}$	25	pF

AC Loading and Waveforms Generic for LCX Family

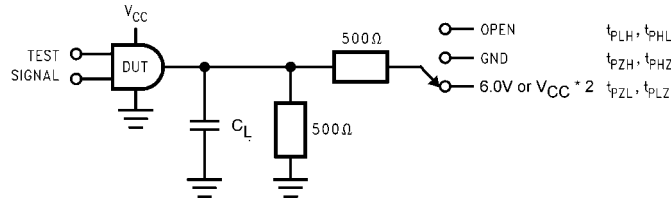
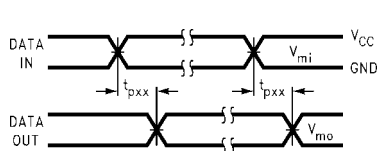
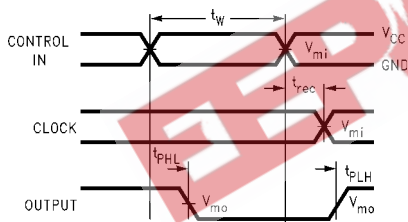

FIGURE 1. AC Test Circuit
(C_L includes probe and jig capacitance)

Test	Switch
t_{PLH}, t_{PHL}	Open
t_{PZL}, t_{PLZ}	6V at $V_{CC} = 3.3 \pm 0.3V$ $V_{CC} \times 2$ at $V_{CC} = 2.5 \pm 0.2V$
t_{PZH}, t_{PHZ}	GND



Waveform for Inverting and Non-Inverting Functions



Propagation Delay, Pulse Width and t_{rec} Waveforms

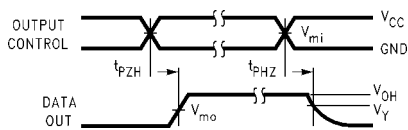

3-STATE Output High Enable and Disable Times for Logic



3-STATE Output Low Enable and Disable Times for Logic

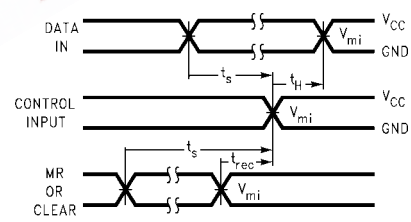

Setup Time, Hold Time and Recovery Time for Logic

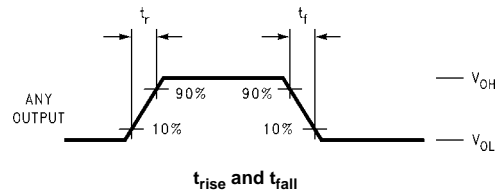

FIGURE 2. Waveforms
(Input Pulse Characteristics; $f = 1\text{MHz}$, $t_r = t_f = 3\text{ns}$)

Symbol	V_{CC}		
	$3.3V \pm 0.3V$	$2.7V$	$2.5V \pm 0.2V$
V_{mi}	1.5V	1.5V	$V_{CC}/2$
V_{mo}	1.5V	1.5V	$V_{CC}/2$
V_x	$V_{OL} + 0.3V$	$V_{OL} + 0.3V$	$V_{OL} + 0.15V$
V_y	$V_{OH} - 0.3V$	$V_{OH} - 0.3V$	$V_{OH} - 0.15V$

Schematic Diagram Generic for LCX Family



Tape and Reel Specification

Tape Format for DQFN

Package Designator	Tape Section	Number Cavities	Cavity Status	Cover Tape Status
BQX	Leader (Start End)	125 (typ)	Empty	Sealed
	Carrier	2500/3000	Filled	Sealed
	Trailer (Hub End)	75 (typ)	Empty	Sealed

TAPE DIMENSIONS inches (millimeters)

PKG. SIZE	DIM.A ₀	DIM.B ₀	DIM.K ₀
3.5 X 4.5	3.8 ± 0.1	4.8 ± 0.1	0.9 ± 0.1
3.0 X 3.0	3.3 ± 0.1	3.3 ± 0.1	0.9 ± 0.1
2.5 X 4.5	2.8 ± 0.1	4.8 ± 0.1	0.9 ± 0.1
2.5 X 3.5	2.8 ± 0.1	3.8 ± 0.1	0.9 ± 0.1
2.5 X 3.0	2.8 ± 0.1	3.3 ± 0.1	0.9 ± 0.1
2.5 X 2.5	2.8 ± 0.1	2.8 ± 0.1	0.9 ± 0.1

DIMENSIONS ARE IN MILLIMETERS

- NOTES: unless otherwise specified
- Cumulative pitch for feeding holes and cavities (chip pockets) not to exceed 0.008[0.20] over 10 pitch span.
 - Smallest allowable bending radius.
 - Thru hole inside cavity is centered within cavity.
 - Tolerance is ±0.002[0.05] for these dimensions on all 12mm tapes.
 - A₀ and B₀ measured on a plane 0.120[0.30] above the bottom of the pocket.
 - K₀ measured from a plane on the inside bottom of the pocket to the top surface of the carrier.
 - Pocket position relative to sprocket hole measured as true position of pocket. Not pocket hole.
 - Controlling dimension is millimeter. Dimension in inches rounded.

REEL DIMENSIONS inches (millimeters)

Tape Size	A	B	C	D	N	W1	W2
12 mm	13.0 (330)	0.059 (1.50)	0.512 (13.00)	0.795 (20.20)	7.008 (178)	0.488 (12.4)	0.724 (18.4)

Physical Dimensions inches (millimeters) unless otherwise noted

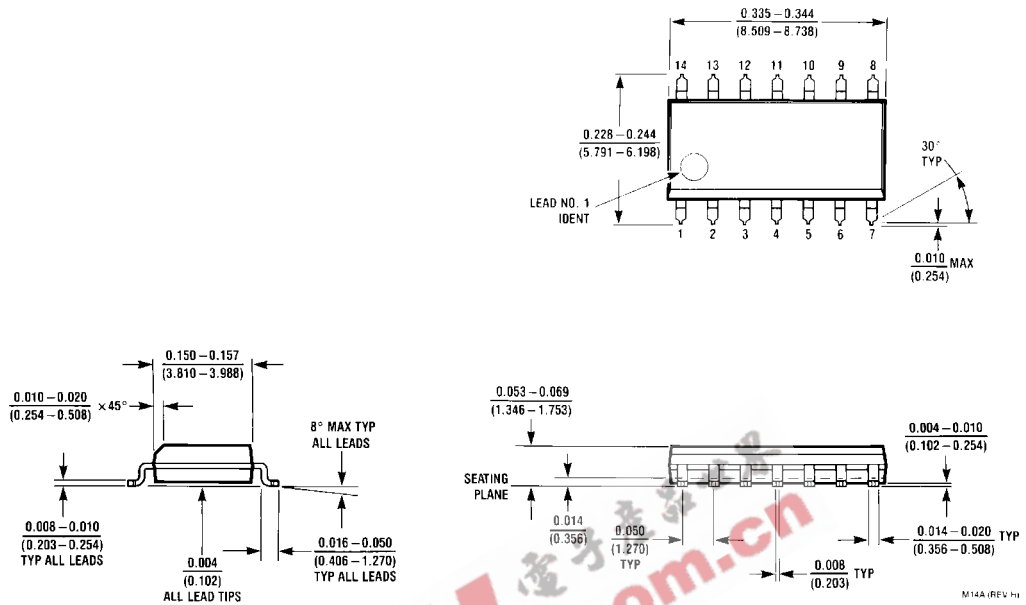

14-Lead Small Outline Integrated Circuit (SOIC), JEDEC MS-012, 0.150" Narrow Package Number M14A

Physical Dimensions inches (millimeters) unless otherwise noted (Continued)

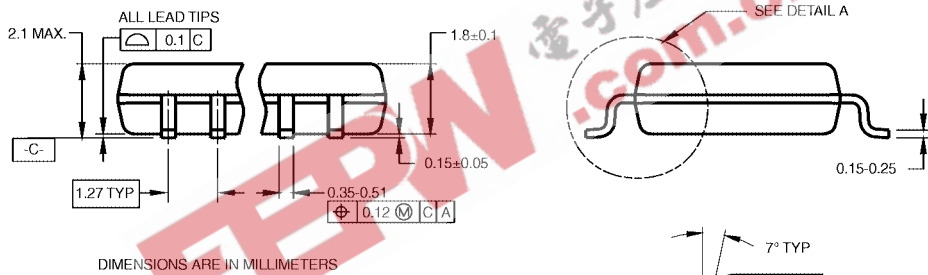
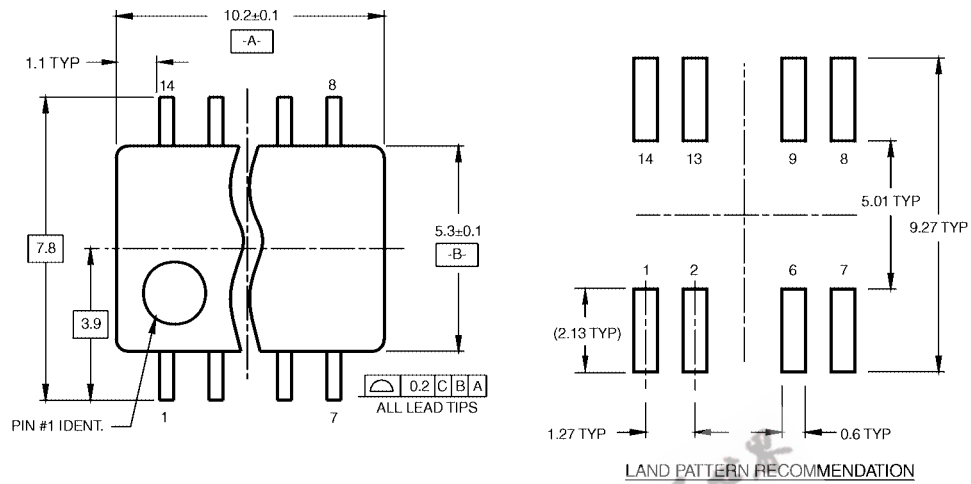

- NOTES:
- A. CONFORMS TO EIAJ EDR-7320 REGISTRATION, ESTABLISHED IN DECEMBER, 1998.
 - B. DIMENSIONS ARE IN MILLIMETERS.
 - C. DIMENSIONS ARE EXCLUSIVE OF BURRS, MOLD FLASH, AND TIE BAR EXTRUSIONS.

M14DRevB1

**Pb-Free 14-Lead Small Outline Package (SOP), EIAJ TYPE II, 5.3mm Wide
Package Number M14D**

Physical Dimensions inches (millimeters) unless otherwise noted (Continued)

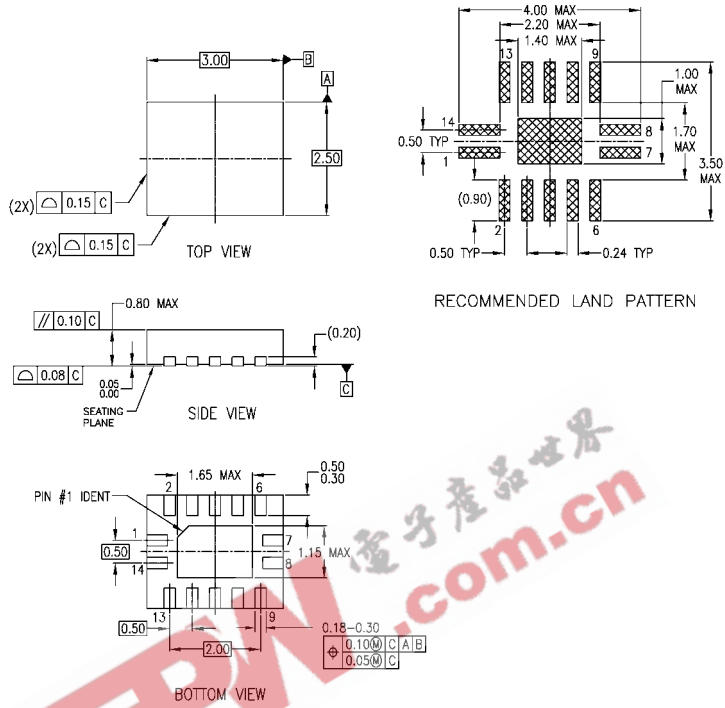

- NOTES:
- A. CONFORMS TO JEDEC REGISTRATION MO-241, VARIATION AA
 - B. DIMENSIONS ARE IN MILLIMETERS.
 - C. DIMENSIONS AND TOLERANCES PER ASME Y14.5M, 1994

MLP014ArevA

Pb-Free 14-Terminal Depopulated Quad Very-Thin Flat Pack No Leads (DQFN), JEDEC MO-241, 2.5 x 3.0mm Package Number MLP014A

Physical Dimensions inches (millimeters) unless otherwise noted (Continued)

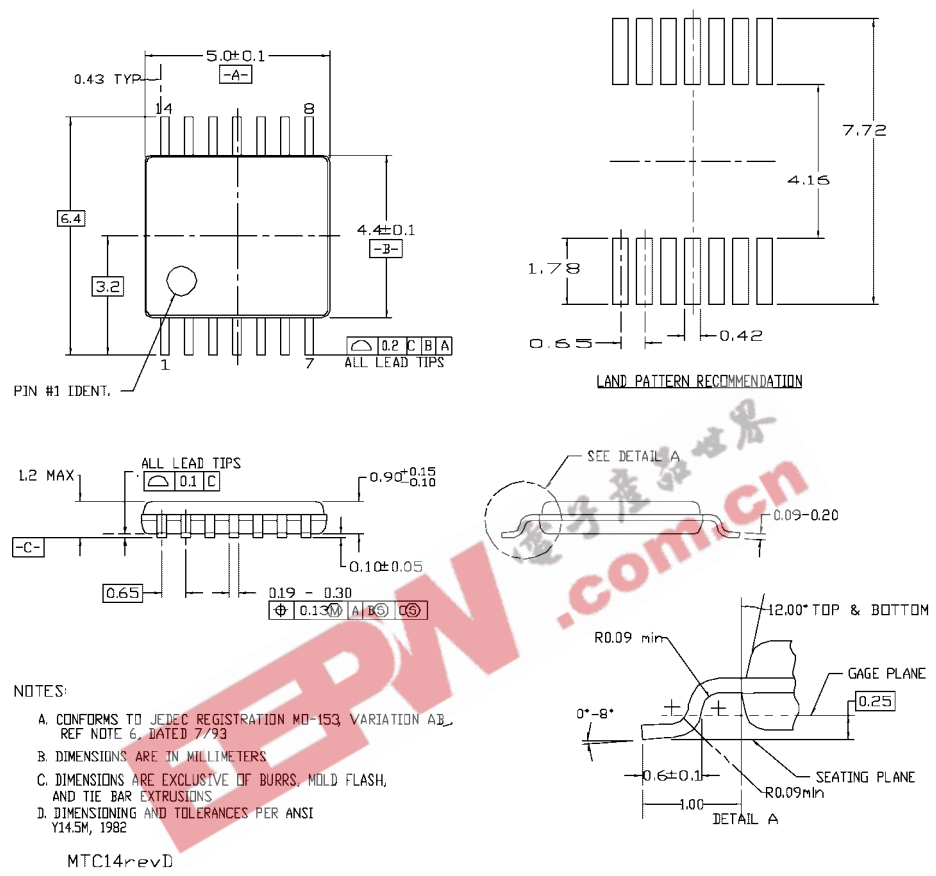

NOTES:
 A. CONFORMS TO JEDEC REGISTRATION MO-153, VARIATION AB, REF NOTE 6, DATED 7/93
 B. DIMENSIONS ARE IN MILLIMETERS
 C. DIMENSIONS ARE EXCLUSIVE OF BURRS, MOLD FLASH, AND TIE BAR EXTRUSIONS
 D. DIMENSIONING AND TOLERANCES PER ANSI Y14.5M, 1982

MTC14revD

14-Lead Thin Shrink Small Outline Package (TSSOP), JEDEC MO-153, 4.4mm Wide Package Number MTC14

Fairchild does not assume any responsibility for use of any circuitry described, no circuit patent licenses are implied and Fairchild reserves the right at any time without notice to change said circuitry and specifications.

LIFE SUPPORT POLICY

FAIRCHILD'S PRODUCTS ARE NOT AUTHORIZED FOR USE AS CRITICAL COMPONENTS IN LIFE SUPPORT DEVICES OR SYSTEMS WITHOUT THE EXPRESS WRITTEN APPROVAL OF THE PRESIDENT OF FAIRCHILD SEMICONDUCTOR CORPORATION. As used herein:

1. Life support devices or systems are devices or systems which, (a) are intended for surgical implant into the body, or (b) support or sustain life, and (c) whose failure to perform when properly used in accordance with instructions for use provided in the labeling, can be reasonably expected to result in a significant injury to the user.
2. A critical component in any component of a life support device or system whose failure to perform can be reasonably expected to cause the failure of the life support device or system, or to affect its safety or effectiveness.

www.fairchildsemi.com