



SCCS054 - August 1994 - Revised March 2000

CY74FCT16373T CY74FCT162373T

16-Bit Latches

Features

- FCT-E speed at 3.4 ns
- Power-off disable outputs permits live insertion
- Edge-rate control circuitry for significantly improved noise characteristics
- Typical output skew < 250 ps
- ESD > 2000V
- TSSOP (19.6-mil pitch) and SSOP (25-mil pitch) packages
- Industrial temperature range of -40°C to $+85^{\circ}\text{C}$
- $V_{CC} = 5\text{V} \pm 10\%$

CY74FCT16373T Features:

- 64 mA sink current, 32 mA source current
- Typical V_{OLP} (ground bounce) < 1.0V at $V_{CC} = 5\text{V}$, $T_A = 25^{\circ}\text{C}$

CY74FCT162373T Features:

- Balanced 24 mA output drivers
- Reduced system switching noise
- Typical V_{OLP} (ground bounce) < 0.6V at $V_{CC} = 5\text{V}$, $T_A = 25^{\circ}\text{C}$

Functional Description

CY74FCT16373T and CY74FCT162373T are 16-bit D-type latches designed for use in bus applications requiring high speed and low power. These devices can be used as two independent 8-bit latches or as a single 16-bit latch by connecting the Output Enable (\overline{OE}) and Latch (LE) inputs. Flow-through pinout and small shrink packaging aid in simplifying board layout. The output buffers are designed with power-off disable feature that allows live insertion of boards.

The CY74FCT16373T is ideally suited for driving high-capacitance loads and low-impedance backplanes.

The CY74FCT162373T has 24-mA balanced output drivers with current limiting resistors in the outputs. This reduces the need for external terminating resistors and provides for minimal undershoot and reduced ground bounce. The CY74FCT162373T is ideal for driving transmission lines.

Logic Block Diagrams

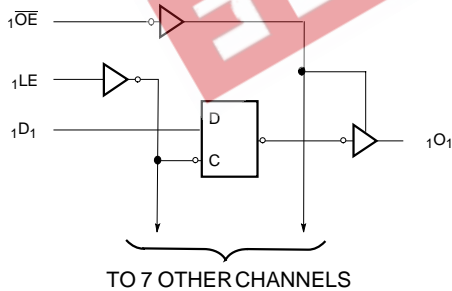

FCT162373-1

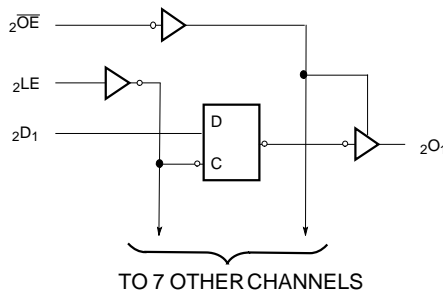

FCT162373-2

Pin Configuration

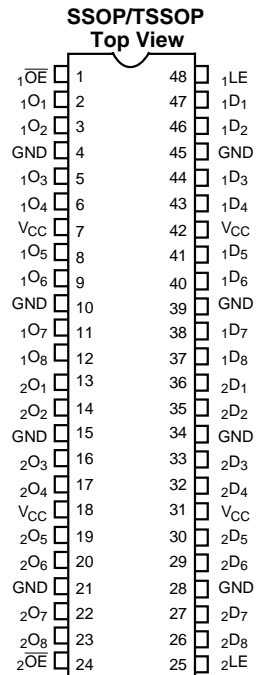

FCT162373-3

Pin Description

Name	Description
D	Data Inputs
LE	Latch Enable Inputs (Active HIGH)
\overline{OE}	Output Enable Inputs (Active LOW)
O	Three-State Outputs

Function Table^[1]

Inputs			Outputs
D	LE	\overline{OE}	O
H	H	L	H
L	H	L	L
X	L	L	Q ₀
X	X	H	Z

Maximum Ratings^[2, 3]

(Above which the useful life may be impaired. For user guidelines, not tested.)

Storage Temperature Com'l -55°C to +125°C

Ambient Temperature with

Power Applied..... Com'l -55°C to +125°C

DC Input Voltage-0.5V to +7.0V

DC Output Voltage-0.5V to +7.0V

DC Output Current

(Maximum Sink Current/Pin)-60 to +120 mA

Power Dissipation 1.0W

Static Discharge Voltage.....>2001V
(per MIL-STD-883, Method 3015)

Operating Range

Range	Ambient Temperature	V _{CC}
Industrial	-40°C to +85°C	5V ± 10%

Electrical Characteristics Over the Operating Range

Parameter	Description	Test Conditions	Min.	Typ. ^[4]	Max.	Unit
V _{IH}	Input HIGH Voltage		2.0			V
V _{IL}	Input LOW Voltage				0.8	V
V _H	Input Hysteresis ^[5]			100		mV
V _{IK}	Input Clamp Diode Voltage	V _{CC} =Min., I _{IN} =-18 mA		-0.7	-1.2	V
I _{IH}	Input HIGH Current	V _{CC} =Max., V _I =V _{CC}			±1	μA
I _{IL}	Input LOW Current	V _{CC} =Max., V _I =GND			±1	μA
I _{OZH}	High Impedance Output Current (Three-State Output pins)	V _{CC} =Max., V _{OUT} =2.7V			±1	μA
I _{OZL}	High Impedance Output Current (Three-State Output pins)	V _{CC} =Max., V _{OUT} =0.5V			±1	μA
I _{OS}	Short Circuit Current ^[6]	V _{CC} =Max., V _{OUT} =GND	-80	-140	-200	mA
I _O	Output Drive Current ^[6]	V _{CC} =Max., V _{OUT} =2.5V	-50		-180	mA
I _{OFF}	Power-Off Disable	V _{CC} =0V, V _{OUT} ≤4.5V ^[7]			±1	μA

Output Drive Characteristics for CY74FCT16373T

Parameter	Description	Test Conditions	Min.	Typ. ^[4]	Max.	Unit
V _{OH}	Output HIGH Voltage	V _{CC} =Min., I _{OH} =-3 mA	2.5	3.5		V
		V _{CC} =Min., I _{OH} =-15 mA	2.4	3.5		V
		V _{CC} =Min., I _{OH} =-32 mA	2.0	3.0		V
V _{OL}	Output LOW Voltage	V _{CC} =Min., I _{OL} =64 mA		0.2	0.55	V

Notes:

- H = HIGH Voltage Level. L = LOW Voltage Level. X = Don't Care. Z = High Impedance. Q₀=Previous state of flip-flop.
- Operation beyond the limits set forth may impair the useful life of the device. Unless otherwise noted, these limits are over the operating free-air temperature range.
- Unused inputs must always be connected to an appropriate logic voltage level, preferably either V_{CC} or ground.
- Typical values are at V_{CC}=5.0V, T_A= +25°C ambient.
- This parameter is specified but not tested.
- Not more than one output should be shorted at a time. Duration of short should not exceed one second. The use of high-speed test apparatus and/or sample and hold techniques are preferable in order to minimize internal chip heating and more accurately reflect operational values. Otherwise prolonged shorting of a high output may raise the chip temperature well above normal and thereby cause invalid readings in other parametric tests. In any sequence of parameter tests, I_{OS} tests should be performed last.
- Tested at +25°C.

Output Drive Characteristics for CY74FCT162373T

Parameter	Description	Test Conditions	Min.	Typ. ^[4]	Max.	Unit
I _{ODL}	Output LOW Current ^[6]	V _{CC} =5V, V _{IN} =V _{IH} or V _{IL} , V _{OUT} =1.5V	60	115	150	mA
I _{ODH}	Output HIGH Current ^[6]	V _{CC} =5V, V _{IN} =V _{IH} or V _{IL} , V _{OUT} =1.5V	-60	-115	-150	mA
V _{OH}	Output HIGH Voltage	V _{CC} =Min., I _{OH} =-24 mA	2.4	3.3		V
V _{OL}	Output LOW Voltage	V _{CC} =Min., I _{OL} =24 mA		0.3	0.55	V

Capacitance^[5] (T_A = +25°C, f = 1.0 MHz)

Parameter	Description	Test Conditions	Typ. ^[4]	Max.	Unit
C _{IN}	Input Capacitance	V _{IN} = 0V	4.5	6.0	pF
C _{OUT}	Output Capacitance	V _{OUT} = 0V	5.5	8.0	pF

Power Supply Characteristics

Parameter	Description	Test Conditions	Typ. ^[4]	Max.	Unit	
I _{CC}	Quiescent Power Supply Current	V _{CC} =Max. V _{IN} ≤0.2V, V _{IN} ≥V _{CC} -0.2V	5	500	μA	
ΔI _{CC}	Quiescent Power Supply Current (TTL inputs HIGH)	V _{CC} =Max. V _{IN} =3.4V ^[8]	0.5	1.5	mA	
I _{CCD}	Dynamic Power Supply Current ^[9]	V _{CC} =Max., One Input Toggling, 50% Duty Cycle, Outputs Open, OE=GND	60	100	μA/MHz	
I _C	Total Power Supply Current ^[10]	V _{CC} =Max., f ₁ =10 MHz, 50% Duty Cycle, Outputs Open, One Bit Toggling, OE=GND, LE=V _{CC}	V _{IN} =V _{CC} or V _{IN} =GND	0.6	1.5	mA
			V _{IN} =3.4V or V _{IN} =GND	0.9	2.3	mA
		V _{CC} =Max., f ₁ =2.5 MHz, 50% Duty Cycle, Outputs Open, Sixteen Bits Toggling, OE=GND, LE=V _{CC}	V _{IN} =V _{CC} or V _{IN} =GND	2.4	4.5 ^[11]	mA
			V _{IN} =3.4V or V _{IN} =GND	6.4	16.5 ^[11]	mA

Notes:

8. Per TTL driven input (V_{IN}=3.4V); all other inputs at V_{CC} or GND.
9. This parameter is not directly testable, but is derived for use in Total Power Supply calculations.
10. I_C = I_{QUIESCENT} + I_{INPUTS} + I_{DYNAMIC}
 $I_C = I_{CC} + \Delta I_{CC} D_H N_T + I_{CCD} (f_0/2 + f_1 N_1)$
 I_{CC} = Quiescent Current with CMOS input levels
 ΔI_{CC} = Power Supply Current for a TTL HIGH input (V_{IN}=3.4V)
 D_H = Duty Cycle for TTL inputs HIGH
 N_T = Number of TTL inputs at D_H
 I_{CCD} = Dynamic Current caused by an input transition pair (HLH or LHL)
 f₀ = Clock frequency for registered devices, otherwise zero
 f₁ = Input signal frequency
 N₁ = Number of inputs changing at f₁
 All currents are in milliamps and all frequencies are in megahertz.
11. Values for these conditions are examples of the I_{CC} formula. These limits are specified but not tested.

Switching Characteristics Over the Operating Range^[12]

Parameter	Description	CY74FCT16373AT CY74FCT162373AT		Unit	Fig. No. ^[13]
		Min.	Max.		
t _{PLH} t _{PHL}	Propagation Delay D to O	1.5	5.2	ns	1, 3
t _{PLH} t _{PHL}	Propagation Delay LE to O	2.0	6.7	ns	1, 5
t _{PZH} t _{PZL}	Output Enable Time	1.5	6.1	ns	1, 7, 8
t _{PHZ} t _{PLZ}	Output Disable Time	1.5	5.5	ns	1, 7, 8
t _{SU}	Set-Up Time HIGH or LOW, D to LE	2.0		ns	9
t _H	Hold Time HIGH or LOW, D to LE	1.5		ns	9
t _W	LE Pulse Width HIGH	3.3		ns	5
t _{SK(O)}	Output Skew ^[14]		0.5	ns	—

Parameter	Description	CY74FCT16373CT CY74FCT162373CT		CY74FCT16373ET CY74FCT162373ET		Unit	Fig. No. ^[13]
		Min.	Max.	Min.	Max.		
t _{PLH} t _{PHL}	Propagation Delay D to O	1.5	4.2	1.5	3.4	ns	1, 3
t _{PLH} t _{PHL}	Propagation Delay LE to O	2.0	5.5	2.0	3.7	ns	1, 5
t _{PZH} t _{PZL}	Output Enable Time	1.5	5.5	1.5	4.4	ns	1, 7, 8
t _{PHZ} t _{PLZ}	Output Disable Time	1.5	5.0	1.5	3.6	ns	1, 7, 8
t _{SU}	Set-Up Time HIGH or LOW, D to LE	2.0		1.0		ns	9
t _H	Hold Time HIGH or LOW, D to LE	1.5		1.0		ns	9
t _W	LE Pulse Width HIGH	3.3		3.0		ns	5
t _{SK(O)}	Output Skew ^[14]		0.5		0.5	ns	—

Notes:

12. Minimum limits are specified but not tested on Propagation Delays.
13. See "Parameter Measurement Information" in the General Information section.
14. Skew between any two outputs of the same package switching in the same direction. This parameter is ensured by design.

Ordering Information CY74FCT16373

Speed (ns)	Ordering Code	Package Name	Package Type	Operating Range
3.4	CY74FCT16373ETPACT	Z48	48-Lead (240-Mil) TSSOP	Industrial
	CY74FCT16373ETPVC/PVCT	O48	48-Lead (300-Mil) SSOP	
4.2	CY74FCT16373CTPACT	Z48	48-Lead (240-Mil) TSSOP	Industrial
	CY74FCT16373CTPVC/PVCT	O48	48-Lead (300-Mil) SSOP	
5.2	CY74FCT16373ATPACT	Z48	48-Lead (240-Mil) TSSOP	Industrial
	CY74FCT16373ATPVC/PVCT	O48	48-Lead (300-Mil) SSOP	

Ordering Information CY74FCT162373

Speed (ns)	Ordering Code	Package Name	Package Type	Operating Range
3.4	74FCT162373ETPACT	Z48	48-Lead (240-Mil) TSSOP	Industrial
	CY74FCT162373ETPVC	O48	48-Lead (300-Mil) SSOP	
	74FCT162373ETPVCT	O48	48-Lead (300-Mil) SSOP	
4.2	74FCT162373CTPACT	Z48	48-Lead (240-Mil) TSSOP	Industrial
	CY74FCT162373CTPVC	O48	48-Lead (300-Mil) SSOP	
	74FCT162373CTPVCT	O48	48-Lead (300-Mil) SSOP	
5.2	74FCT162373ATPACT	Z48	48-Lead (240-Mil) TSSOP	Industrial
	CY74FCT162373ATPVC	O48	48-Lead (300-Mil) SSOP	
	74FCT162373ATPVCT	O48	48-Lead (300-Mil) SSOP	

Package Diagrams

48-Lead Shrunken Small Outline Package O48

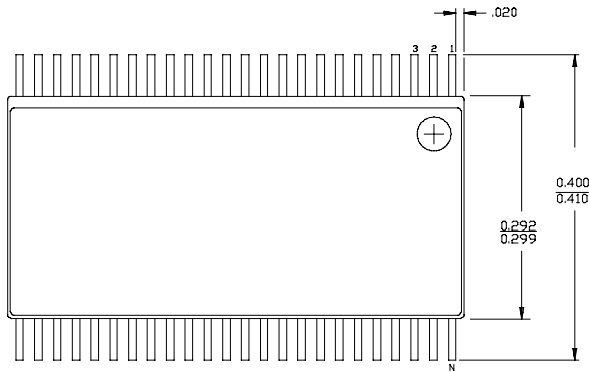

DIMENSIONS IN INCHES MIN.
MAX.

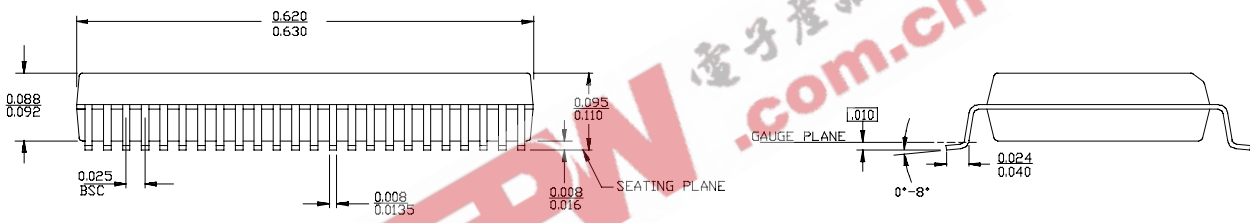

48-Lead Thin Shrunken Small Outline Package Z48

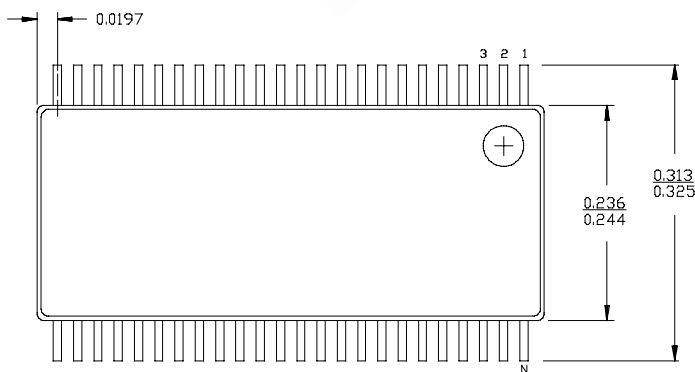

DIMENSIONS IN INCHES MIN.
MAX.

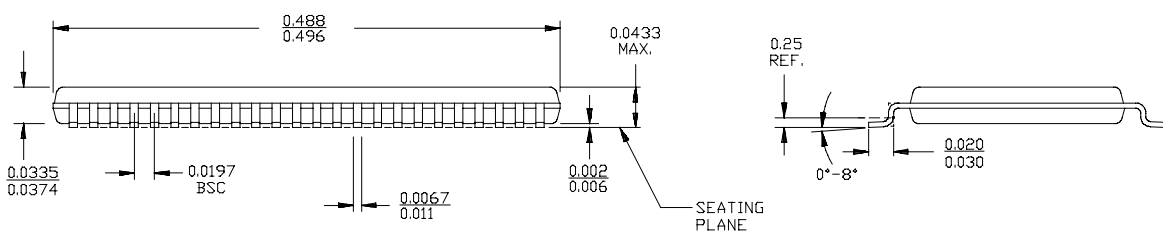

IMPORTANT NOTICE

Texas Instruments and its subsidiaries (TI) reserve the right to make changes to their products or to discontinue any product or service without notice, and advise customers to obtain the latest version of relevant information to verify, before placing orders, that information being relied on is current and complete. All products are sold subject to the terms and conditions of sale supplied at the time of order acknowledgement, including those pertaining to warranty, patent infringement, and limitation of liability.

TI warrants performance of its semiconductor products to the specifications applicable at the time of sale in accordance with TI's standard warranty. Testing and other quality control techniques are utilized to the extent TI deems necessary to support this warranty. Specific testing of all parameters of each device is not necessarily performed, except those mandated by government requirements.

CERTAIN APPLICATIONS USING SEMICONDUCTOR PRODUCTS MAY INVOLVE POTENTIAL RISKS OF DEATH, PERSONAL INJURY, OR SEVERE PROPERTY OR ENVIRONMENTAL DAMAGE ("CRITICAL APPLICATIONS"). TI SEMICONDUCTOR PRODUCTS ARE NOT DESIGNED, AUTHORIZED, OR WARRANTED TO BE SUITABLE FOR USE IN LIFE-SUPPORT DEVICES OR SYSTEMS OR OTHER CRITICAL APPLICATIONS. INCLUSION OF TI PRODUCTS IN SUCH APPLICATIONS IS UNDERSTOOD TO BE FULLY AT THE CUSTOMER'S RISK.

In order to minimize risks associated with the customer's applications, adequate design and operating safeguards must be provided by the customer to minimize inherent or procedural hazards.

TI assumes no liability for applications assistance or customer product design. TI does not warrant or represent that any license, either express or implied, is granted under any patent right, copyright, mask work right, or other intellectual property right of TI covering or relating to any combination, machine, or process in which such semiconductor products or services might be or are used. TI's publication of information regarding any third party's products or services does not constitute TI's approval, warranty or endorsement thereof.