

74LVX163 Low Voltage Synchronous Binary Counter with Synchronous Clear

General Description

The LVX163 is a synchronous modulo-16 binary counter. This device is synchronously presettable for application in programmable dividers and has two types of Count Enable inputs plus a Terminal Count output for versatility in forming multistage counters. The CLK input is active on the rising edge. Both PE and CLR inputs are active on low logic levels. Presetting is synchronous to rising edge of CLK and the Clear function of the LVX163 is synchronous to CLK. Two enable inputs (ENP and ENT) and Carry Output are provided to enable easy cascading of counters, which facilitates easy implementation of n-bit counters without using external gates.

The inputs tolerate voltages up to 7V allowing the interface of 5V systems to 3V systems.

Features

- Input voltage level translation from 5V to 3V
- Ideal for low power/low noise 3.3V applications
- Available in SOIC JEDEC, SOIC EIAJ, and TSSOP packages
- Guaranteed simultaneous switching noise and dynamic threshold performance

Logic Symbols

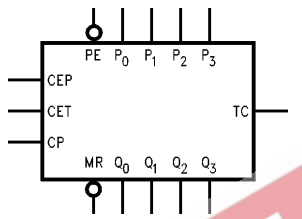

TL/F/12157-1

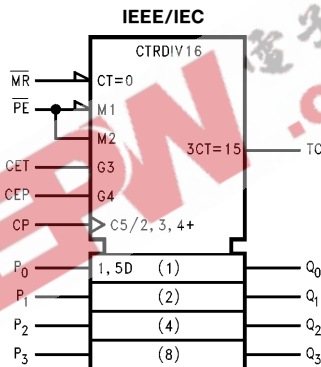

TL/F/12157-2

Connection Diagram

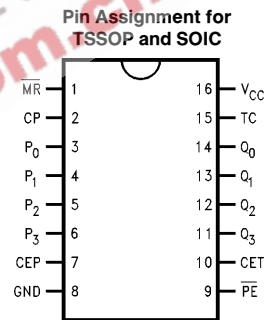

TL/F/12157-3

	SOIC JEDEC	SOIC EIAJ	TSSOP
Order Number	74LVX163M 74LVX163MX	74LVX163SJ 74LVX163SJX	74LVX163MTC 74LVX163MTCX
See NS Package Number	M16A	M16D	MTC16

Pin Names	Description
CEP	Count Enable Parallel Input
CET	Count Enable Trickle Input
CP	Clock Pulse Input
MR	Synchronous Master Reset Input
P ₀ -P ₃	Parallel Data Inputs
PE	Parallel Enable Inputs
Q ₀ -Q ₃	Flip-Flop Outputs
TC	Terminal Count Output

Functional Description

The LVX163 counts in modulo-16 binary sequence. From state 15 (HHHH) it increments to state 0 (LLLL). The clock inputs of all flip-flops are driven in parallel through a clock buffer. Thus all changes of the Q outputs occur as a result of, and synchronous with, the LOW-to-HIGH transition of the CP input signal. The circuits have four fundamental modes of operation, in order of precedence: synchronous reset, parallel load, count-up and hold. Four control inputs—Synchronous Reset (\overline{MR}), Parallel Enable (\overline{PE}), Count Enable Parallel (CEP) and Count Enable Trickle (CET)—determine the mode of operation, as shown in the Mode Select Table. A LOW signal on \overline{MR} overrides counting and parallel loading and allows all outputs to go LOW on the next rising edge of CP. A LOW signal on \overline{PE} overrides counting and allows information on the Parallel Data (P_n) inputs to be loaded into the flip-flops on the next rising edge of CP. With \overline{PE} and \overline{MR} HIGH, CEP and CET permit counting when both are HIGH. Conversely, a LOW signal on either CEP or CET inhibits counting.

The LVX163 uses D-type edge-triggered flip-flops and changing the \overline{MR} , \overline{PE} , CEP and CET inputs when the CP is in either state does not cause errors, provided that the recommended setup and hold times, with respect to the rising edge of CP, are observed.

The Terminal Count (TC) output is HIGH when CET is HIGH and counter is in state 15. To implement synchronous multi-stage counters, the TC outputs can be used with the CEP and CET inputs in two different ways.

Figure 1 shows the connections for simple ripple carry, in which the clock period must be longer than the CP to TC delay of the first stage, plus the cumulative CET to TC delays of the intermediate stages, plus the CET to CP setup time of the last stage. This total delay plus setup time sets the upper limit on clock frequency. For faster clock rates, the carry lookahead connections shown in Figure 2 are recommended. In this scheme the ripple delay through the intermediate stages commences with the same clock that causes the first stage to tick over from max to min in the Up mode, or min to max in the Down mode, to start its final cycle. Since this final cycle takes 16 clocks to complete, there is plenty of time for the ripple to progress through the intermediate stages. The critical timing that limits the clock period is the CP to TC delay of the first stage plus the CEP to CP setup time of the last stage. The TC output is subject to decoding spikes due to internal race conditions and is therefore not recommended for use as a clock or asynchro-

nous reset for flip-flops, registers or counters. When the Output Enable (\overline{OE}) is LOW, the parallel data outputs O_0 – O_3 are active and follow the flip-flop Q outputs. A HIGH signal on \overline{OE} forces O_0 – O_3 to the High Z state but does not prevent counting, loading or resetting.

$$\text{Logic Equations: Count Enable} = \text{CEP} \cdot \text{CET} \cdot \overline{\text{PE}}$$

$$\text{TC} = Q_0 \cdot Q_1 \cdot Q_2 \cdot Q_3 \cdot \text{CET}$$

Mode Select Table

\overline{MR}	\overline{PE}	CET	CEP	Action on the Rising Clock Edge (\nearrow)
L	X	X	X	Reset (Clear)
H	L	X	X	Load ($P_n \rightarrow Q_n$)
H	H	H	H	Count (Increment)
H	H	L	X	No Change (Hold)
H	H	X	L	No Change (Hold)

H = HIGH Voltage Level
L = LOW Voltage Level
X = Immaterial

State Diagram

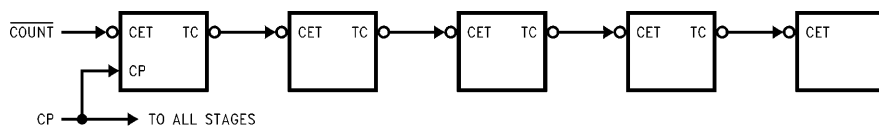
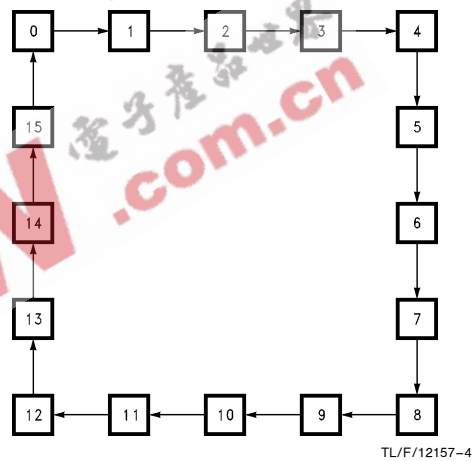

FIGURE 1

TL/F/12157-5

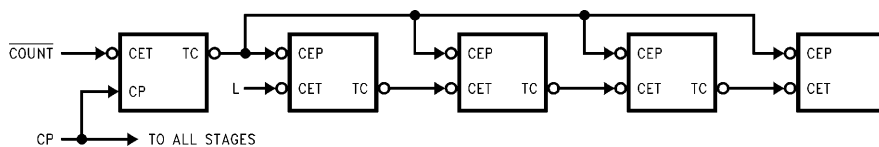
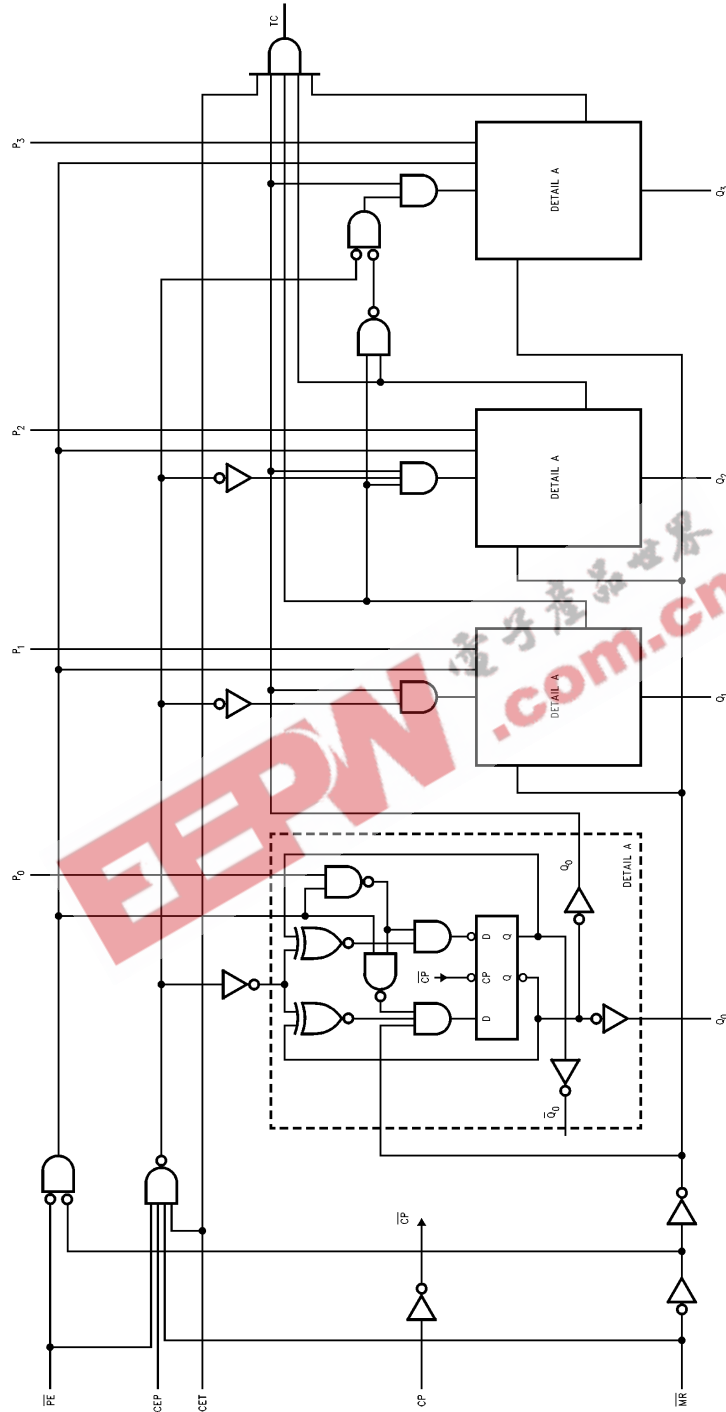

FIGURE 2

TL/F/12157-6

Block Diagram



TL/F/12157-7

Please note that this diagram is provided only for the understanding of logic operations and should not be used to estimate propagation delays.

Absolute Maximum Ratings (Note)

Supply Voltage (V_{CC})	-0.5V to +7.0V
DC Input Diode Current (I_{IK})	-20 mA
$V_I = -0.5V$	
DC Input Voltage (V_I)	-0.5V to 7V
DC Output Diode Current (I_{OK})	-20 mA
$V_O = -0.5V$	
$V_O = V_{CC} + 0.5V$	+20 mA
DC Output Voltage (V_O)	-0.5V to $V_{CC} + 0.5V$
DC Output Source or Sink Current (I_O)	± 25 mA
DC V_{CC} or Ground Current (I_{CC} or I_{GND})	± 50 mA
Storage Temperature (T_{STG})	-65°C to +150°C
Power Dissipation	180 mW

Note: The "Absolute Maximum Ratings" are those values beyond which the safety of the device cannot be guaranteed. The device should not be operated at these limits. The parametric values defined in the "Electrical Characteristics" table are not guaranteed at the absolute maximum ratings. The "Recommended Operating Conditions" table will define the conditions for actual device operation.

Recommended Operating Conditions

Supply Voltage (V_{CC})	2.0V to 3.6V
Input Voltage (V_I)	0V to 5.5V
Output Voltage (V_O)	0V to V_{CC}
Operating Temperature (T_A)	-40°C to +85°C
Input Rise and Fall Time ($\Delta t_r/\Delta t_f$)	0 ns/V to 100 ns/V

DC Electrical Characteristics

Symbol	Parameter	V_{CC}	74LVX163			74LVX163		Units	Conditions
			$T_A = +25^\circ\text{C}$			$T_A = -40^\circ\text{C to } +85^\circ\text{C}$			
			Min	Typ	Max	Min	Max		
V_{IH}	High Level Input Voltage	2.0 3.0 3.6	1.5 2.0 2.4			1.5 2.0 2.4	V		
V_{IL}	Low Level Input Voltage	2.0 3.0 3.6		0.5 0.8 0.8		0.5 0.8 0.8	V		
V_{OH}	High Level Output Voltage	2.0 3.0 3.0	1.9 2.9 2.58	2.0 3.0		1.9 2.9 2.48	V	$V_{IN} = V_{IL}$ or V_{IH} $I_{OH} = -50 \mu\text{A}$ $I_{OH} = -50 \mu\text{A}$ $I_{OH} = -4 \text{mA}$	
V_{OL}	Low Level Output Voltage	2.0 3.0 3.0		0.0 0.0 0.36		0.1 0.1 0.44	V	$V_{IN} = V_{IL}$ or V_{IH} $I_{OL} = 50 \mu\text{A}$ $I_{OL} = 50 \mu\text{A}$ $I_{OL} = 4 \text{mA}$	
I_{IN}	Input Leakage Current	3.6		± 0.1		± 1.0	μA	$V_{IN} = 5.5V$ or GND	
I_{CC}	Quiescent Supply Current	3.6		2.0		20.0	μA	$V_{IN} = V_{CC}$ or GND	

Noise Characteristics						
Symbol	Parameter	V _{CC} (V)	LVX163		Units	C _L (pF)
			T _A = 25°C			
			Typ	Limits		
V _{OLP} *	Quiet Output Maximum Dynamic V _{OL}	3.3	0.2	0.5	V	50
V _{OLV} *	Quiet Output Minimum Dynamic V _{OL}	3.3	-0.2	-0.5	V	50
V _{IHD} *	Minimum High Level Dynamic Input Voltage	3.3		2.0	V	50
V _{ILD} *	Maximum Low Level Dynamic Input Voltage	3.3		0.8	V	50

*Parameter guaranteed by design.

AC Electrical Characteristics									
Symbol	Parameter	V _{CC} (V)	LVX163			LVX163		Units	Conditions
			T _A = 25°C			T _A = -40°C to +85°C			
			Min	Typ	Max	Min	Max		
t _{PLH} , t _{PHL}	Propagation Delay Time (CP-Q _n)	2.7	9.0	14.0	1.0	16.0	ns	C _L = 15 pF	
			11.3	17.0	1.0	19.0		C _L = 50 pF	
		3.3 ± 0.3	8.3	12.8	1.0	15.0	ns	C _L = 15 pF	
			10.8	16.3	1.0	18.5		C _L = 50 pF	
t _{PLH} , t _{PHL}	Propagation Delay Time (CP-TC, Count)	2.7	9.5	14.3	1.0	16.7	ns	C _L = 15 pF	
			12.5	18.5	1.0	20.5		C _L = 50 pF	
		3.3 ± 0.3	8.7	13.6	1.0	16.0	ns	C _L = 15 pF	
			11.2	17.1	1.0	19.5		C _L = 50 pF	
t _{PLH} , t _{PHL}	Propagation Delay Time (CP-TC, Load)	2.7	11.4	18.0	1.0	21.0	ns	C _L = 15 pF	
			14.0	21.0	1.0	24.0		C _L = 50 pF	
		3.3 ± 0.3	11.0	17.2	1.0	20.0	ns	C _L = 15 pF	
			13.5	20.7	1.0	23.5		C _L = 50 pF	
t _{PLH} , t _{PHL}	Propagation Delay Time (CET-TC)	2.7	8.6	13.5	1.0	15.0	ns	C _L = 15 pF	
			11.0	16.5	1.0	18.5		C _L = 50 pF	
		3.3 ± 0.3	7.5	12.3	1.0	14.5	ns	C _L = 15 pF	
			10.5	15.8	1.0	18.0		C _L = 50 pF	
f _{max}	Maximum Clock Frequency	2.7	75	115	65	MHz	C _L = 15 pF		
			50	80	45		C _L = 50 pF		
		3.3 ± 0.3	80	130	70	MHz	C _L = 15 pF		
			55	85	50		C _L = 50 pF		
C _{IN}	Input Capacitance		4	10	10	pF	V _{CC} = Open		
C _{PD}	Power Dissipation Capacitance		23			pF	(Note 1)		

Note 1: C_{PD} is defined as the value of the internal equivalent capacitance which is calculated from the operating current consumption without load. Average operating current can be obtained by the equation: I_{CC (opr)} = C_{PD} * V_{CC} * f_{IN} + I_{CC}.
When the outputs drive a capacitive load, total current consumption is the sum of C_{PD} and ΔI_{CC} which is obtained from the following formula:

$$\Delta I_{CC} = F_{CP} \cdot V_{CC} \left(\frac{C_{Q0}}{2} + \frac{C_{Q1}}{4} + \frac{C_{Q2}}{8} + \frac{C_{Q3}}{16} + \frac{C_{TC}}{16} \right)$$

C_{Q0}-C_{Q3} and C_{TC} are the capacitances at Q0-Q3 and TC, respectively. F_{CP} is the input frequency of the CP.

AC Operating Requirements

Symbol	Parameter	V _{CC} (V)	LVX163	LVX163	Units	Conditions
			T _A = 25°C	T _A = -40°C to +85°C		
			Guaranteed Minimum			
t _S	Minimum Setup Time (P _n -CP)	2.7 3.3 ± 0.3	5.5 5.5	6.5 6.5	ns	
t _S	Minimum Setup Time (PE-CP)	2.7 3.3 ± 0.3	8.0 8.0	9.5 9.5	ns	
t _S	Minimum Setup Time (CEP or CET-CP)	2.7 3.3 ± 0.3	7.5 7.5	9.0 9.0	ns	
t _S	Minimum Setup Time (MR-CP)	2.7 3.3 ± 0.3	4.0 4.0	4.0 4.0	ns	
t _H	Minimum Hold Time (P _n -CP)	2.7 3.3 ± 0.3	1.0 1.0	1.0 1.0	ns	
t _H	Minimum Hold Time (PE-CP)	2.7 3.3 ± 0.3	1.0 1.0	1.0 1.0	ns	
t _H	Minimum Hold Time (CEP or CET-CP)	2.7 3.3 ± 0.3	1.0 1.0	1.0 1.0	ns	
t _H	Minimum Hold Time (MR-CP)	2.7 3.3 ± 0.3	1.5 1.5	1.5 1.5	ns	
t _{W(L)} t _{W(H)}	Minimum Pulse Width CP (Count)	2.7 3.3 ± 0.3	5.0 5.0	5.0 5.0	ns	

Ordering Information

The device number is used to form part of a simplified purchasing code, where the package type and temperature range are defined as follows:

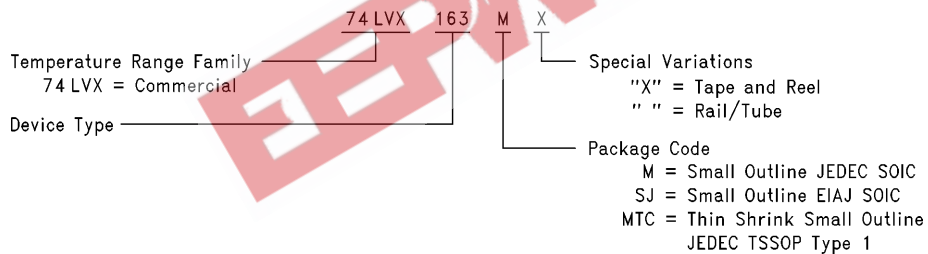

TL/F/12157-8

Physical Dimensions inches (millimeters) unless otherwise noted

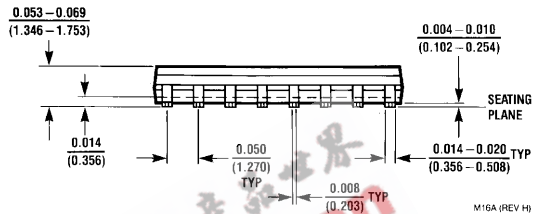
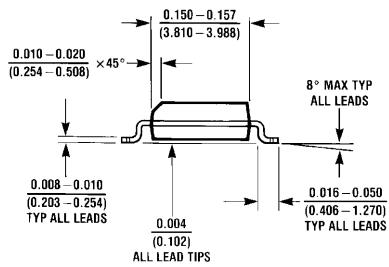
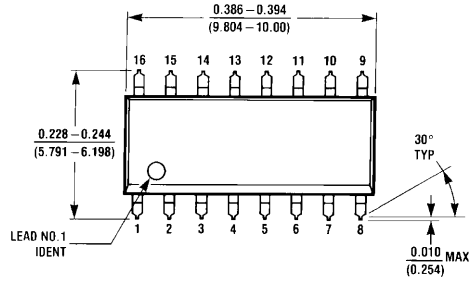

16-Lead Molded JEDEC SOIC
Order Number 74LVX163M
NS Package Number M16A

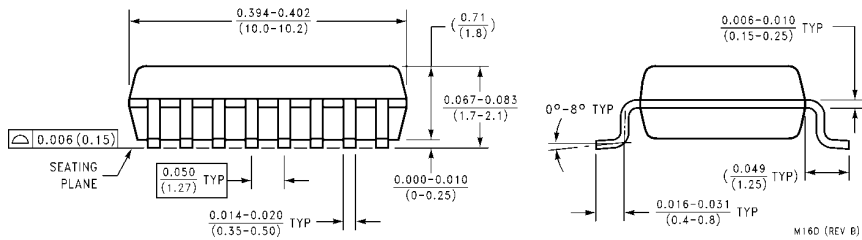
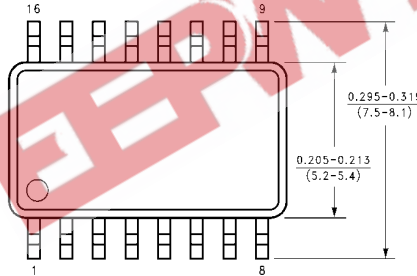

16-Lead Molded EIAJ SOIC
Order Number 74LVX163SJ
NS Package Number M16D

Physical Dimensions inches (millimeters) unless otherwise noted (Continued)

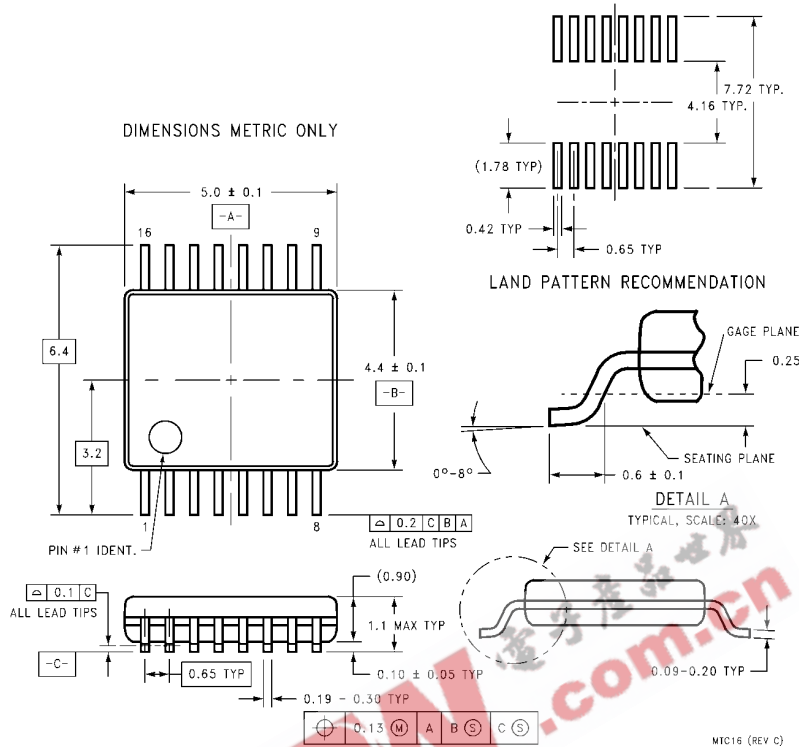

16-Lead Molded JEDEC Type 1 TSSOP
Order Number 74LVX163MTC
NS Package Number MTC16

MTC16 (REV C)

LIFE SUPPORT POLICY

NATIONAL'S PRODUCTS ARE NOT AUTHORIZED FOR USE AS CRITICAL COMPONENTS IN LIFE SUPPORT DEVICES OR SYSTEMS WITHOUT THE EXPRESS WRITTEN APPROVAL OF THE PRESIDENT OF NATIONAL SEMICONDUCTOR CORPORATION. As used herein:

1. Life support devices or systems are devices or systems which, (a) are intended for surgical implant into the body, or (b) support or sustain life, and whose failure to perform, when properly used in accordance with instructions for use provided in the labeling, can be reasonably expected to result in a significant injury to the user.
2. A critical component is any component of a life support device or system whose failure to perform can be reasonably expected to cause the failure of the life support device or system, or to affect its safety or effectiveness.



National Semiconductor Corporation
Americas
 Tel: 1(800) 272-9959
 Fax: 1(800) 737-7018
 Email: support@nsc.com

<http://www.national.com>

National Semiconductor Europe

Fax: +49 (0) 180-530 85 86
 Email: europe.support@nsc.com
 Deutsch Tel: +49 (0) 180-530 85 85
 English Tel: +49 (0) 180-532 78 32
 Français Tel: +49 (0) 180-532 93 58
 Italiano Tel: +49 (0) 180-534 16 80

National Semiconductor Southeast Asia

Fax: (852) 2376 3901
 Email: sea.support@nsc.com

National Semiconductor Japan Ltd.

Tel: 81-3-5620-7561
 Fax: 81-3-5620-6179