

DATA SHEET

EEPW 电子产品世界
.com.cn

74HC14; 74HCT14 Hex inverting Schmitt trigger

Product specification
Supersedes data of 1997 Aug 26

2003 Oct 30

Hex inverting Schmitt trigger

74HC14; 74HCT14

FEATURES

- Applications:
 - Wave and pulse shapers
 - Astable multivibrators
 - Monostable multivibrators.
- Complies with JEDEC standard no. 7A
- ESD protection:
HBM EIA/JESD22-A114-A exceeds 2000 V
MM EIA/JESD22-A115-A exceeds 200 V.
- Specified from -40 to $+85$ °C and -40 to $+125$ °C.

DESCRIPTION

The 74HC14 and 74HCT14 are high-speed Si-gate CMOS devices and are pin compatible with low power Schottky TTL (LSTTL). They are specified in compliance with JEDEC standard no. 7A.

The 74HC14 and 74HCT14 provide six inverting buffers with Schmitt-trigger action. They are capable of transforming slowly changing input signals into sharply defined, jitter-free output signals.

QUICK REFERENCE DATA

GND = 0 V; $T_{amb} = 25$ °C; $t_r = t_f = 6$ ns

SYMBOL	PARAMETER	CONDITIONS	TYPICAL		UNIT
			HC	HCT	
t_{PHL}/t_{PLH}	propagation delay nA to nY	$C_L = 15$ pF; $V_{CC} = 5$ V	12	17	ns
C_I	input capacitance		3.5	3.5	pF
C_{PD}	power dissipation capacitance per gate	notes 1 and 2	7	8	pF

Notes

1. C_{PD} is used to determine the dynamic power dissipation (P_D in μ W):

$$P_D = C_{PD} \times V_{CC}^2 \times f_i \times N + \Sigma(C_L \times V_{CC}^2 \times f_o)$$
 where:
 f_i = input frequency in MHz;
 f_o = output frequency in MHz;
 C_L = output load capacitance in pF;
 V_{CC} = supply voltage in Volts;
 N = total load switching outputs;
 $\Sigma(C_L \times V_{CC}^2 \times f_o)$ = sum of the outputs.
2. For type 74HC14 the condition is $V_I = \text{GND to } V_{CC}$.
 For type 74HCT14 the condition is $V_I = \text{GND to } V_{CC} - 1.5$ V.

Hex inverting Schmitt trigger

74HC14; 74HCT14

FUNCTION TABLE

INPUT	OUTPUT
nA	nY
L	H
H	L

Note

1. H = HIGH voltage level;
L = LOW voltage level.

ORDERING INFORMATION

TYPE NUMBER	PACKAGE				
	TEMPERATURE RANGE	PINS	PACKAGE	MATERIAL	CODE
74HC14D	-40 to +125 °C	14	SO14	plastic	SOT108-1
74HCT14D	-40 to +125 °C	14	SO14	plastic	SOT108-1
74HC14DB	-40 to +125 °C	14	SSOP14	plastic	SOT337-1
74HCT14DB	-40 to +125 °C	14	SSOP14	plastic	SOT337-1
74HC14N	-40 to +125 °C	14	DIP14	plastic	SOT27-1
74HCT14N	-40 to +125 °C	14	DIP14	plastic	SOT27-1
74HC14PW	-40 to +125 °C	14	TSSOP14	plastic	SOT402-1
74HCT14PW	-40 to +125 °C	14	TSSOP14	plastic	SOT402-1
74HC14BQ	-40 to +125 °C	14	DHVQFN14	plastic	SOT762-1
74HCT14BQ	-40 to +125 °C	14	DHVQFN14	plastic	SOT762-1

PINNING

PIN	SYMBOL	DESCRIPTION
1	1A	data input
2	1Y	data output
3	2A	data input
4	2Y	data output
5	3A	data input
6	3Y	data output
7	GND	ground (0 V)
8	4Y	data output
9	4A	data input
10	5Y	data output
11	5A	data input
12	6Y	data output
13	6A	data input
14	V _{CC}	supply voltage

Hex inverting Schmitt trigger

74HC14; 74HCT14

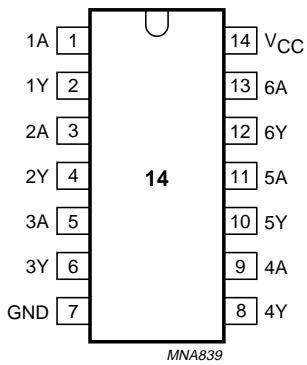
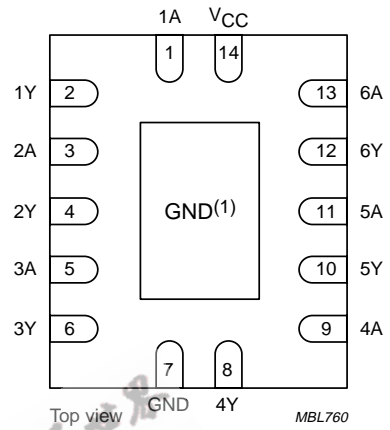

Fig.1 Pin configuration.



(1) The die substrate is attached to this pad using conductive die attach material. It can not be used as a supply pin or input.

Fig.2 Pin configuration DHVQFN14.

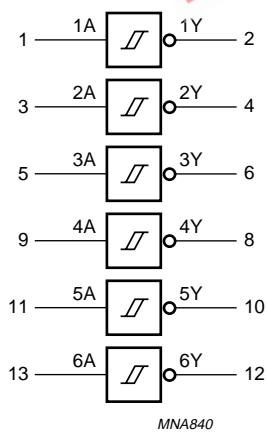

Fig.3 Logic symbol.

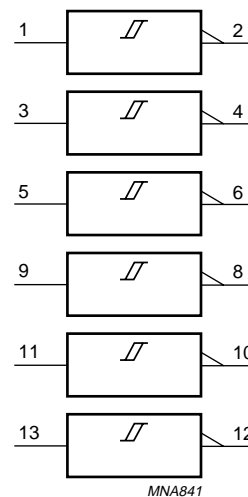
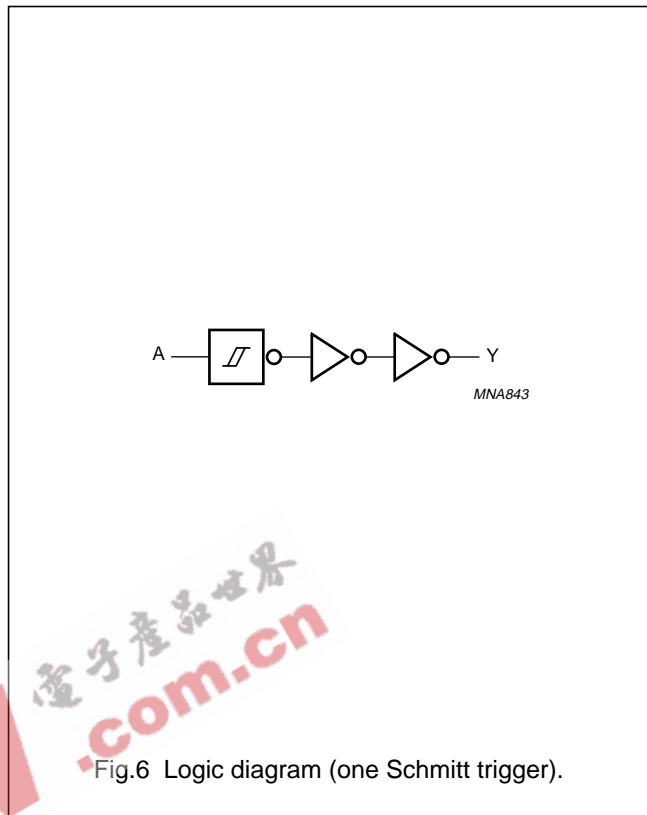
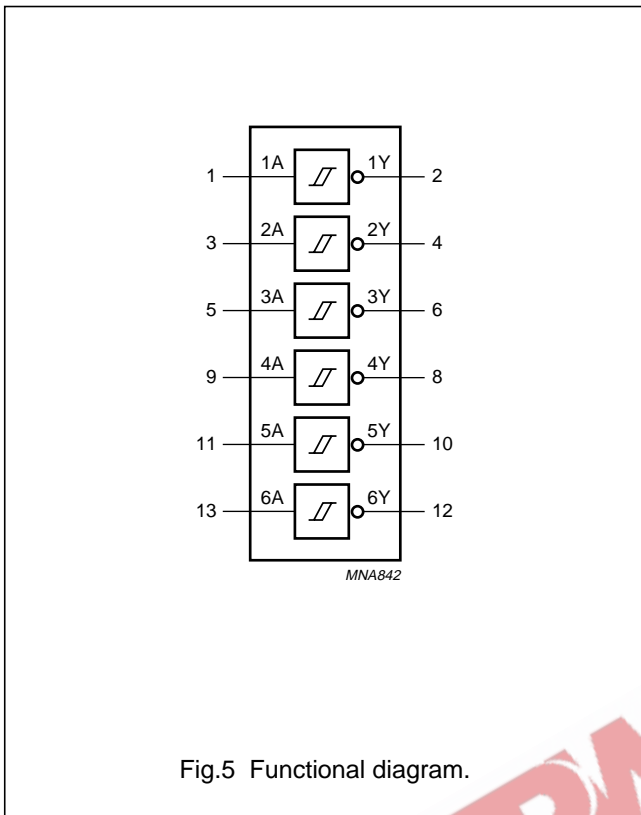

Fig.4 IEC logic symbol.

Hex inverting Schmitt trigger

74HC14; 74HCT14



EEPW.com.cn
电子產品世界

Hex inverting Schmitt trigger

74HC14; 74HCT14

RECOMMENDED OPERATING CONDITIONS

SYMBOL	PARAMETER	CONDITIONS	74HC14			74HCT14			UNIT
			MIN.	TYP.	MAX.	MIN.	TYP.	MAX.	
V_{CC}	supply voltage		2.0	5.0	6.0	4.5	5.0	5.5	V
V_I	input voltage		0	–	V_{CC}	0	–	V_{CC}	V
V_O	output voltage		0	–	V_{CC}	0	–	V_{CC}	V
T_{amb}	operating ambient temperature	see DC and AC characteristics per device	–40	+25	+85	–40	+25	+85	°C
			–40	–	+125	–40	–	+125	°C

LIMITING VALUES

In accordance with the Absolute Maximum System (IEC 60134); voltages are referenced to GND (ground = 0 V).

SYMBOL	PARAMETER	CONDITIONS	MIN.	MAX.	UNIT
V_{CC}	supply voltage		–0.5	+7	V
I_{IK}	input diode current	$V_I < -0.5\text{ V}$ or $V_I > V_{CC} + 0.5\text{ V}$	–	± 20	mA
I_{OK}	output diode current	$V_O < -0.5\text{ V}$ or $V_O > V_{CC} + 0.5\text{ V}$	–	± 20	mA
I_O	output source or sink current	$-0.5\text{ V} < V_O < V_{CC} + 0.5\text{ V}$	–	± 25	mA
$I_{CC}; I_{GND}$	V_{CC} or GND current		–	50	mA
T_{stg}	storage temperature		–65	+150	°C
P_{tot}	power dissipation	$T_{amb} = -40\text{ to }+125\text{ °C}$			
		DIP14 packages; note 1	–	750	mW
		Other packages; note 2	–	500	mW

Notes

- For DIP14 packages: above 70 °C the value of P_D derates linearly with 12 mW/K.
- For SO14 packages: above 70 °C the value of P_D derates linearly with 8 mW/K.
For (T)SSOP14 packages: above 60 °C the value of P_D derates linearly with 5.5 mW/K.
For DHVQFN14 packages: above 60 °C the value of P_D derates linearly with 4.5 mW/K.

Hex inverting Schmitt trigger

74HC14; 74HCT14

DC CHARACTERISTICS

Type 74HC14

At recommended operating conditions; voltages are referenced to GND (ground = 0 V).

SYMBOL	PARAMETER	TEST CONDITIONS		MIN.	TYP. ⁽¹⁾	MAX.	UNIT
		OTHER	V _{CC} (V)				
T_{amb} = 25 °C							
V _{OH}	HIGH-level output voltage	V _I = V _{IH} or V _{IL}					
		I _O = -20 μA	2.0	1.9	2.0	–	V
		I _O = -20 μA	4.5	4.4	4.5	–	V
		I _O = -20 μA	6.0	5.9	6.0	–	V
		I _O = -4.0 mA	4.5	3.98	4.32	–	V
		I _O = -5.2 mA	6.0	5.48	5.81	–	V
V _{OL}	LOW-level output voltage	V _I = V _{IH} or V _{IL}					
		I _O = 20 μA	2.0	–	0	0.1	V
		I _O = 20 μA	4.5	–	0	0.1	V
		I _O = 20 μA	6.0	–	0	0.1	V
		I _O = 4.0 mA	4.5	–	0.15	0.26	V
		I _O = 5.2 mA	6.0	–	0.16	0.26	V
I _{LI}	input leakage current	V _I = V _{CC} or GND	6.0	–	–	0.1	μA
I _{CC}	quiescent supply current	V _I = V _{CC} or GND; I _O = 0	6.0	–	–	2.0	μA
T_{amb} = -40 to +85 °C							
V _{OH}	HIGH-level output voltage	V _I = V _{IH} or V _{IL}					
		I _O = -20 μA	2.0	1.9	–	–	V
		I _O = -20 μA	4.5	4.4	–	–	V
		I _O = -20 μA	6.0	5.9	–	–	V
		I _O = -4.0 mA	4.5	3.84	–	–	V
		I _O = -5.2 mA	6.0	5.34	–	–	V
V _{OL}	LOW-level output voltage	V _I = V _{IH} or V _{IL}					
		I _O = 20 μA	2.0	–	–	0.1	V
		I _O = 20 μA	4.5	–	–	0.1	V
		I _O = 20 μA	6.0	–	–	0.1	V
		I _O = 4.0 mA	4.5	–	–	0.33	V
		I _O = 5.2 mA	6.0	–	–	0.33	V
I _{LI}	input leakage current	V _I = V _{CC} or GND	6.0	–	–	1.0	μA
I _{CC}	quiescent supply current	V _I = V _{CC} or GND; I _O = 0	6.0	–	–	20	μA

Hex inverting Schmitt trigger

74HC14; 74HCT14

SYMBOL	PARAMETER	TEST CONDITIONS		MIN.	TYP. ⁽¹⁾	MAX.	UNIT
		OTHER	V _{CC} (V)				
T_{amb} = -40 to +125 °C							
V _{OH}	HIGH-level output voltage	V _I = V _{IH} or V _{IL}					
		I _O = -20 μA	2.0	1.9	-	-	V
		I _O = -20 μA	4.5	4.4	-	-	V
		I _O = -20 μA	6.0	5.9	-	-	V
		I _O = -4.0 mA	4.5	3.7	-	-	V
		I _O = -5.2 mA	6.0	5.2	-	-	V
V _{OL}	LOW-level output voltage	V _I = V _{IH} or V _{IL}					
		I _O = 20 μA	2.0	-	-	0.1	V
		I _O = 20 μA	4.5	-	-	0.1	V
		I _O = 20 μA	6.0	-	-	0.1	V
		I _O = 4.0 mA	4.5	-	-	0.4	V
		I _O = 5.2 mA	6.0	-	-	0.4	V
I _{LI}	input leakage current	V _I = V _{CC} or GND	6.0	-	-	1.0	μA
I _{CC}	quiescent supply current	V _I = V _{CC} or GND; I _O = 0	6.0	-	-	40	μA

Note

1. All typical values are measured at T_{amb} = 25 °C.

Hex inverting Schmitt trigger

74HC14; 74HCT14

Type 74HCT14

At recommended operating conditions; voltages are referenced to GND (ground = 0 V).

SYMBOL	PARAMETER	TEST CONDITIONS		MIN.	TYP. ⁽¹⁾	MAX.	UNIT
		OTHER	V _{CC} (V)				
T_{amb} = 25 °C							
V _{OH}	HIGH-level output voltage	V _I = V _{IH} or V _{IL}	4.5	4.4	4.5	–	V
		I _O = –20 µA I _O = –4.0 mA	4.5	3.98	4.32	–	V
V _{OL}	LOW-level output voltage	V _I = V _{IH} or V _{IL}	4.5	–	0	0.1	V
		I _O = 20 µA I _O = 4.0 mA	4.5	–	0.15	0.26	V
I _{LI}	input leakage current	V _I = V _{CC} or GND	5.5	–	–	0.1	µA
I _{CC}	quiescent supply current	V _I = V _{CC} or GND; I _O = 0	5.5	–	–	2.0	µA
ΔI _{CC}	additional supply current per input	V _I = V _{CC} – 2.1 V; I _O = 0	4.5 to 5.5	–	30	108	µA
T_{amb} = –40 to +85 °C							
V _{OH}	HIGH-level output voltage	V _I = V _{IH} or V _{IL}	4.5	4.4	–	–	V
		I _O = –20 µA I _O = –4.0 mA	4.5	3.84	–	–	V
V _{OL}	LOW-level output voltage	V _I = V _{IH} or V _{IL}	4.5	–	–	0.1	V
		I _O = 20 µA I _O = 4.0 mA	4.5	–	–	0.33	V
I _{LI}	input leakage current	V _I = V _{CC} or GND	5.5	–	–	1.0	µA
I _{CC}	quiescent supply current	V _I = V _{CC} or GND; I _O = 0	5.5	–	–	20	µA
ΔI _{CC}	additional supply current per input	V _I = V _{CC} – 2.1 V; I _O = 0	4.5 to 5.5	–	–	135	µA
T_{amb} = –40 to +125 °C							
V _{OH}	HIGH-level output voltage	V _I = V _{IH} or V _{IL}	4.5	4.4	–	–	V
		I _O = –20 µA I _O = –4.0 mA	4.5	3.7	–	–	V
V _{OL}	LOW-level output voltage	V _I = V _{IH} or V _{IL}	4.5	–	–	0.1	V
		I _O = 20 µA I _O = 4.0 mA	4.5	–	–	0.4	V
I _{LI}	input leakage current	V _I = V _{CC} or GND	5.5	–	–	1.0	µA
I _{CC}	quiescent supply current	V _I = V _{CC} or GND; I _O = 0	5.5	–	–	40	µA
ΔI _{CC}	additional supply current per input	V _I = V _{CC} – 2.1 V; I _O = 0	4.5 to 5.5	–	–	147	µA

Note1. All typical values are measured at T_{amb} = 25 °C.

Hex inverting Schmitt trigger

74HC14; 74HCT14

TRANSFER CHARACTERISTICS

Type 74HC

At recommended operating conditions; voltages are referenced to GND (ground = 0 V).

SYMBOL	PARAMETER	TEST CONDITIONS		MIN.	TYP.	MAX.	UNIT
		WAVEFORMS	V _{CC} (V)				
T_{amb} = 25 °C; note 1							
V _{T+}	positive-going threshold	Figs 7 and 8	2.0	0.7	1.18	1.5	V
			4.5	1.7	2.38	3.15	V
			6.0	2.1	3.14	4.2	V
V _{T-}	negative-going threshold	Figs 7 and 8	2.0	0.3	0.52	0.90	V
			4.5	0.9	1.40	2.00	V
			6.0	1.2	1.89	2.60	V
V _H	hysteresis (V _{T+} - V _{T-})	Figs 7 and 8	2.0	0.2	0.66	1.0	V
			4.5	0.4	0.98	1.4	V
			6.0	0.6	1.25	1.6	V
T_{amb} = -40 to +85 °C							
V _{T+}	positive-going threshold	Figs 7 and 8	2.0	0.7	–	1.5	V
			4.5	1.7	–	3.15	V
			6.0	2.1	–	4.2	V
V _{T-}	negative-going threshold	Figs 7 and 8	2.0	0.3	–	0.90	V
			4.5	0.90	–	2.00	V
			6.0	1.20	–	2.60	V
V _H	hysteresis (V _{T+} - V _{T-})	Figs 7 and 8	2.0	0.2	–	1.0	V
			4.5	0.4	–	1.4	V
			6.0	0.6	–	1.6	V
T_{amb} = -40 to +125 °C							
V _{T+}	positive-going threshold	Figs 7 and 8	2.0	0.7	–	1.5	V
			4.5	1.7	–	3.15	V
			6.0	2.1	–	4.2	V
V _{T-}	negative-going threshold	Figs 7 and 8	2.0	0.30	–	0.90	V
			4.5	0.90	–	2.00	V
			6.0	1.2	–	2.60	V
V _H	hysteresis (V _{T+} - V _{T-})	Figs 7 and 8	2.0	0.2	–	1.0	V
			4.5	0.4	–	1.4	V
			6.0	0.6	–	1.6	V

Note

1. All typical values are measured at T_{amb} = 25 °C.

Hex inverting Schmitt trigger

74HC14; 74HCT14

Family 74HCT

At recommended operating conditions: voltages are referenced to GND (ground = 0 V)

SYMBOL	PARAMETER	TEST CONDITIONS		MIN.	TYP.	MAX.	UNIT
		WAVEFORMS	V _{CC} (V)				
T_{amb} = 25 °C; note 1							
V _{T+}	positive-going threshold	Figs 7 and 8	4.5	1.2	1.41	1.9	V
			5.5	1.4	1.59	2.1	V
V _{T-}	negative-going threshold	Figs 7 and 8	4.5	0.5	0.85	1.2	V
			5.5	0.6	0.99	1.4	V
V _H	hysteresis (V _{T+} – V _{T-})	Figs 7 and 8	4.5	0.4	0.56	–	V
			5.5	0.4	0.60	–	V
T_{amb} = –40 to +85 °C							
V _{T+}	positive-going threshold	Figs 7 and 8	4.5	1.2	–	1.9	V
			5.5	1.4	–	2.1	V
V _{T-}	negative-going threshold	Figs 7 and 8	4.5	0.5	–	1.2	V
			5.5	0.6	–	1.4	V
V _H	hysteresis (V _{T+} – V _{T-})	Figs 7 and 8	4.5	0.4	–	–	V
			5.5	0.4	–	–	V
T_{amb} = –40 to +125 °C							
V _{T+}	positive-going threshold	Figs 7 and 8	4.5	1.2	–	1.9	V
			5.5	1.4	–	2.1	V
V _{T-}	negative-going threshold	Figs 7 and 8	4.5	0.5	–	1.2	V
			5.5	0.6	–	1.4	V
V _H	hysteresis (V _{T+} – V _{T-})	Figs 7 and 8	4.5	0.4	–	–	V
			5.5	0.4	–	–	V

Note

1. All typical values are measured at T_{amb} = 25 °C.

Hex inverting Schmitt trigger

74HC14; 74HCT14

AC CHARACTERISTICS

Type 74HC

GND = 0 V; $t_r = t_f = 6$ ns; $C_L = 50$ pF

SYMBOL	PARAMETER	TEST CONDITIONS		MIN.	TYP.	MAX.	UNIT
		WAVEFORMS	V_{CC} (V)				
$T_{amb} = 25$ °C; note 1							
t_{PHL}/t_{PLH}	propagation delay nA to nY	see Fig.9	2.0	–	41	125	ns
			4.5	–	15	25	ns
			6.0	–	12	21	ns
t_{THL}/t_{TLH}	output transition time	see Fig.9	2.0	–	19	75	ns
			4.5	–	7	15	ns
			6.0	–	6	13	ns
$T_{amb} = -40$ to $+85$ °C							
t_{PHL}/t_{PLH}	propagation delay nA to nY	see Fig.9	2.0	–	–	155	ns
			4.5	–	–	31	ns
			6.0	–	–	26	ns
t_{THL}/t_{TLH}	output transition time	see Fig.9	2.0	–	–	95	ns
			4.5	–	–	19	ns
			6.0	–	–	15	ns
$T_{amb} = -40$ to $+125$ °C							
t_{PHL}/t_{PLH}	propagation delay nA to nY	see Fig.9	2.0	–	–	190	ns
			4.5	–	–	38	ns
			6.0	–	–	32	ns
t_{THL}/t_{TLH}	output transition time	see Fig.9	2.0	–	–	110	ns
			4.5	–	–	22	ns
			6.0	–	–	19	ns

Note

1. All typical values are measured at $T_{amb} = 25$ °C.

Hex inverting Schmitt trigger

74HC14; 74HCT14

Type 74HCT

GND = 0 V; $t_r = t_f = 6 \text{ ns}$; $C_L = 50 \text{ pF}$

SYMBOL	PARAMETER	TEST CONDITIONS		MIN.	TYP.	MAX.	UNIT
		WAVEFORMS	V _{CC} (V)				
T_{amb} = 25 °C ; note 1							
t _{PHL} /t _{PLH}	propagation delay nA to nY	see Fig.9	4.5	–	20	34	ns
t _{THL} /t _{TLH}	output transition time	see Fig.9	4.5	–	7	15	ns
T_{amb} = –40 to +85 °C							
t _{PHL} /t _{PLH}	propagation delay nA to nY	see Fig.9	4.5	43	–	–	ns
t _{THL} /t _{TLH}	output transition time	see Fig.9	4.5	19	–	–	ns
T_{amb} = –40 to +125 °C							
t _{PHL} /t _{PLH}	propagation delay nA to nY	see Fig.9	4.5	–	–	51	ns
t _{THL} /t _{TLH}	output transition time	see Fig.9	4.5	–	–	22	ns

Note

1. All typical values are measured at T_{amb} = 25 °C.

TRANSFER CHARACTERISTIC WAVEFORMS

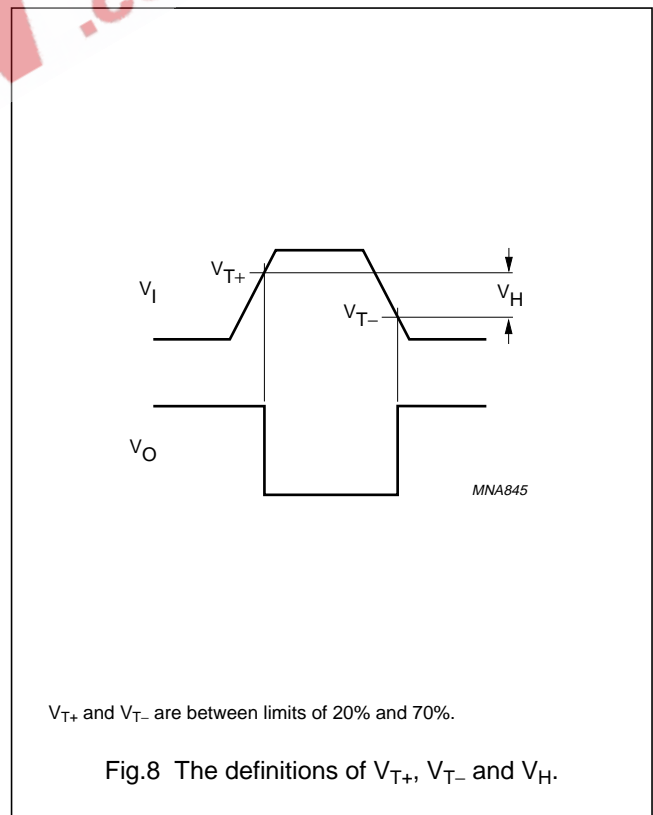
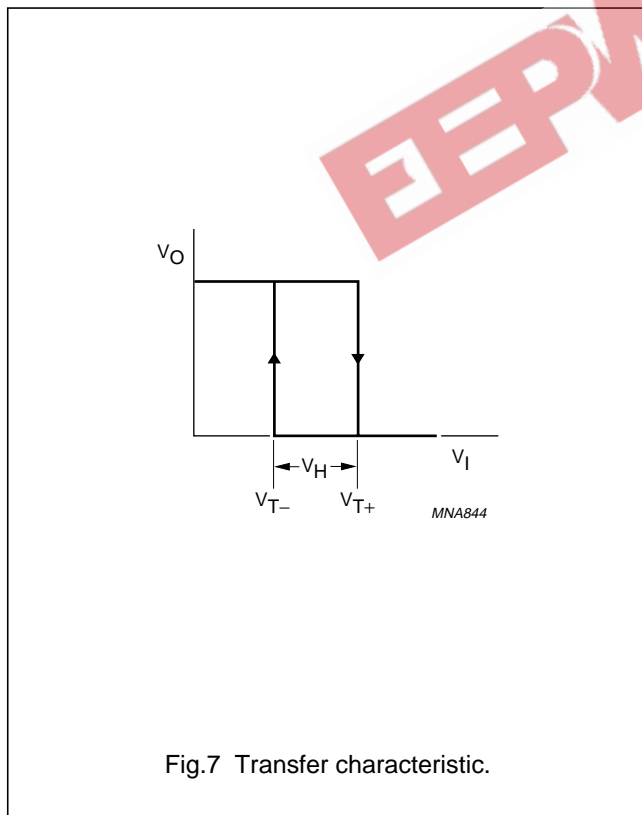

Hex inverting Schmitt trigger

74HC14; 74HCT14

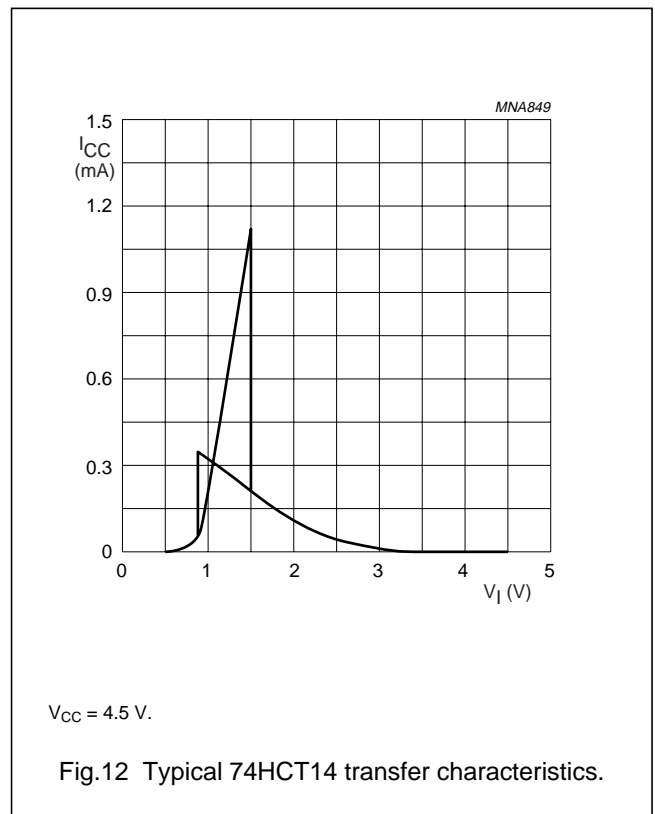
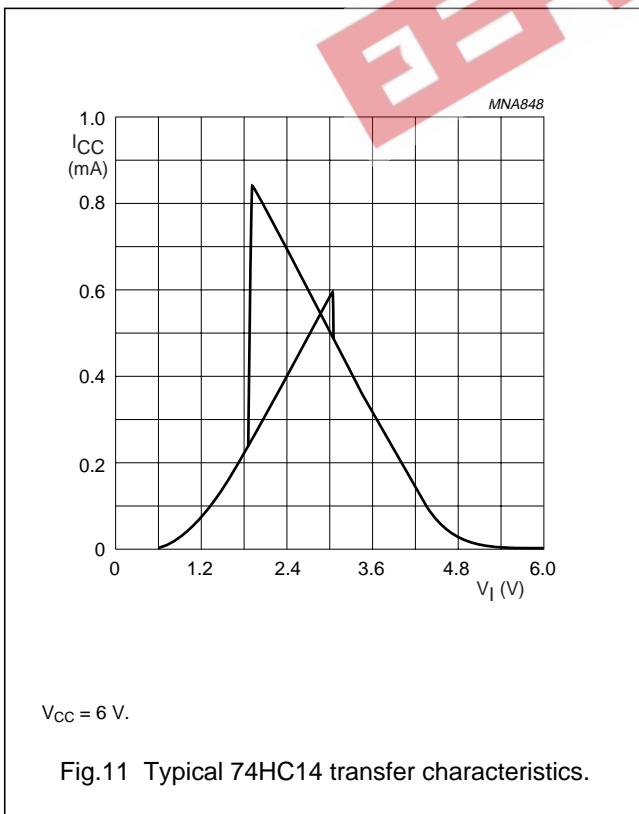
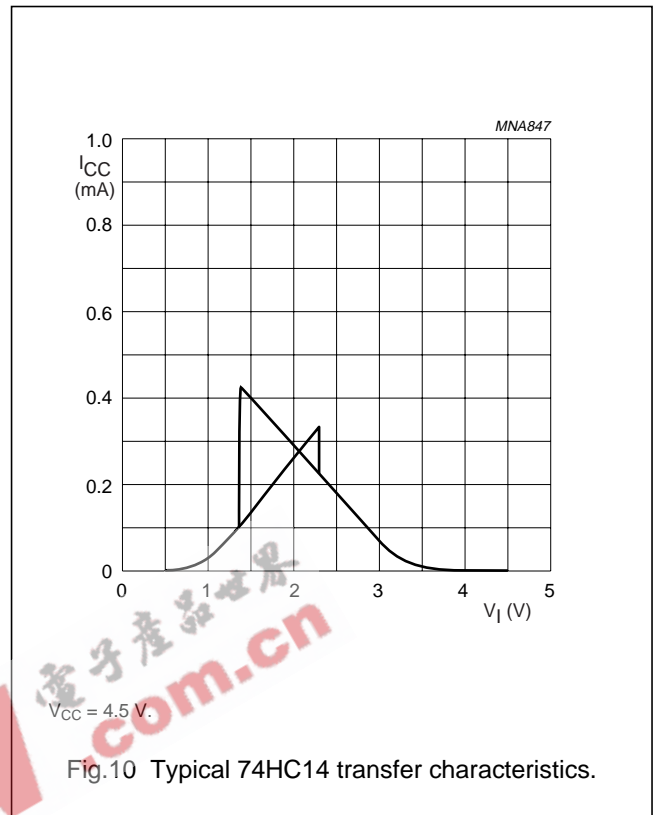
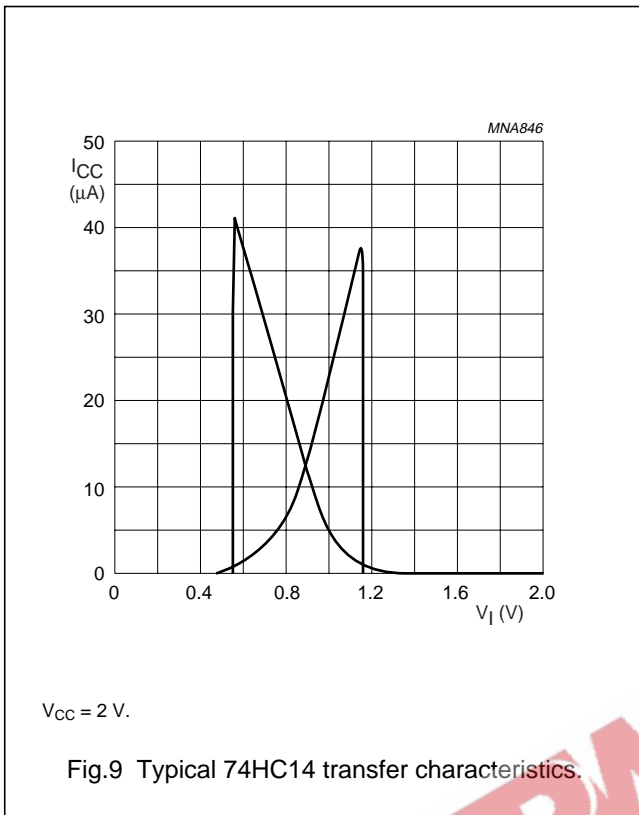

Hex inverting Schmitt trigger

74HC14; 74HCT14

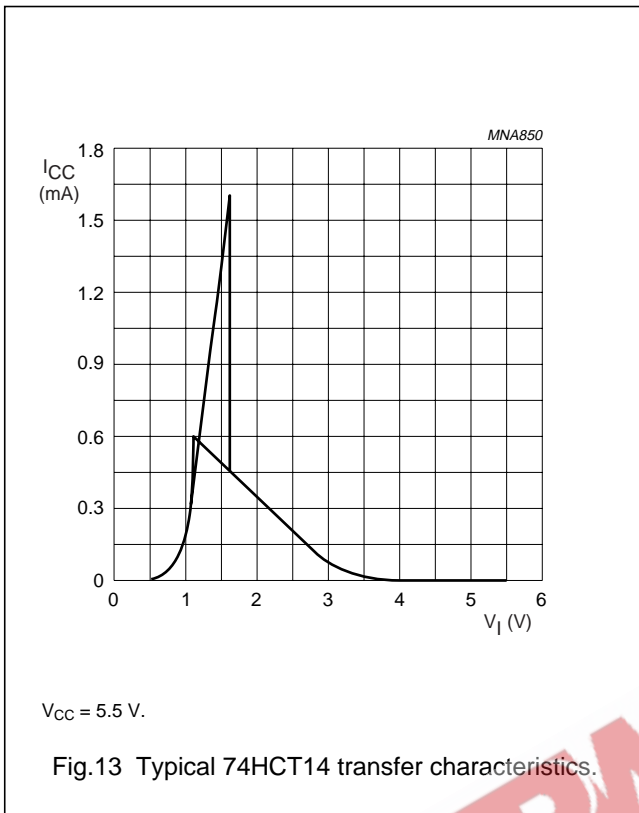

AC WAVEFORMS

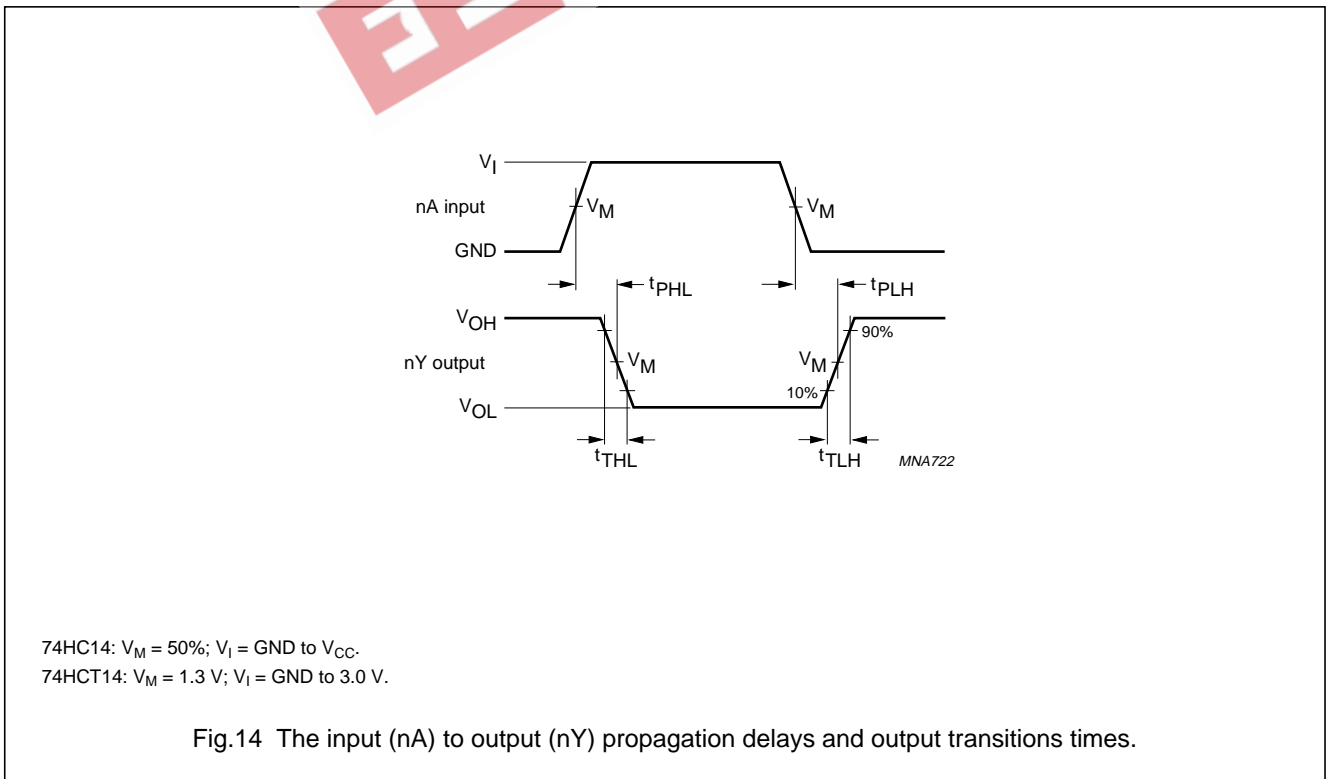

Hex inverting Schmitt trigger

74HC14; 74HCT14

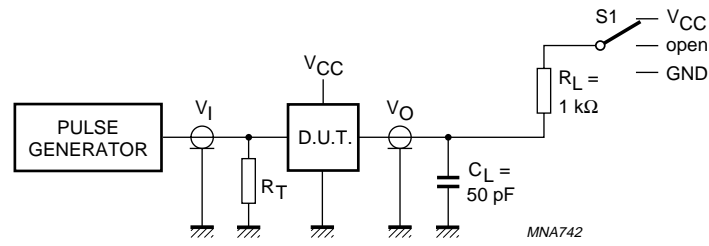

TEST	S1
t_{PLH}/t_{PHL}	open
t_{PLZ}/t_{PZL}	V_{CC}
t_{PHZ}/t_{PZH}	GND

Definitions for test circuit:

R_L = Load resistor.

C_L = load capacitance including jig and probe capacitance.

R_T = termination resistance should be equal to the output impedance Z_o of the pulse generator.

Fig.15 Load circuitry for switching times.

Hex inverting Schmitt trigger

74HC14; 74HCT14

APPLICATION INFORMATION

The slow input rise and fall times cause additional power dissipation. This can be calculated using the following formula:

$$P_{ad} = f_i \times (t_r \times I_{CC(AV)} + t_f \times I_{CC(AV)}) \times V_{CC}$$

Where:

P_{ad} = additional power dissipation (μW);

f_i = input frequency (MHz);

t_r = input rise time (μs); 10% to 90%;

t_f = input fall time (μs); 10% to 90%;

$I_{CC(AV)}$ = average additional supply current (μA).

$I_{CC(AV)}$ differs with positive or negative input transitions, as shown in Figs 16 and 17.

For 74HC/HCT14 used in a relaxation oscillator circuit, see Fig.18.

Note to application information

All values given are typical unless otherwise specified.

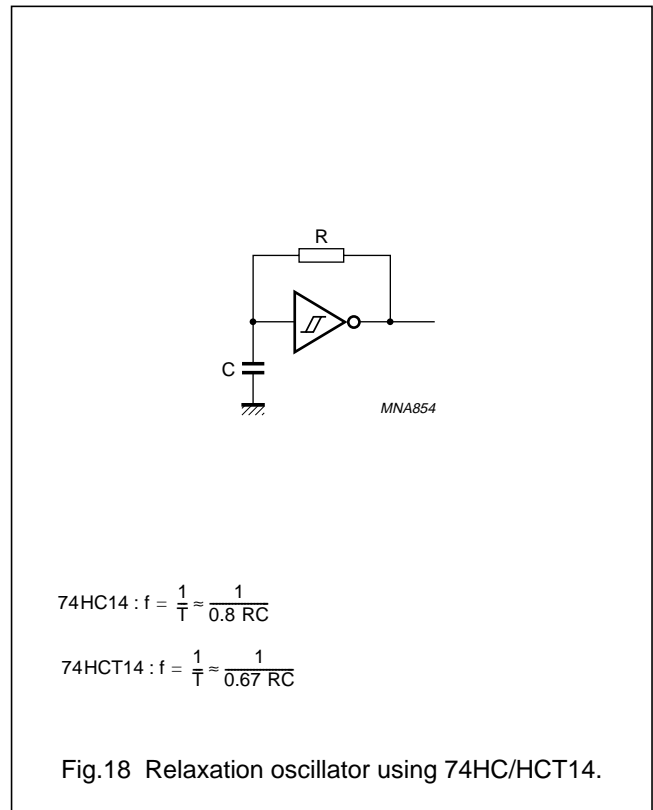
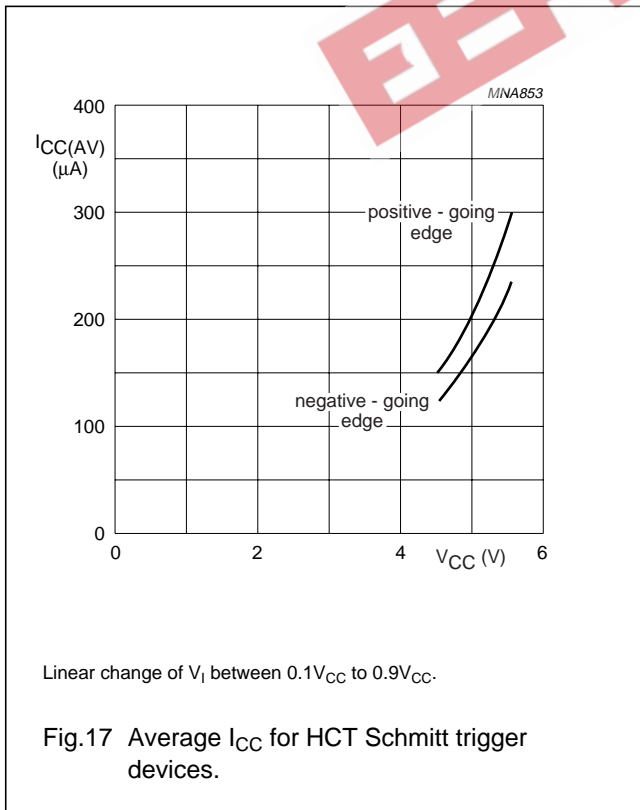
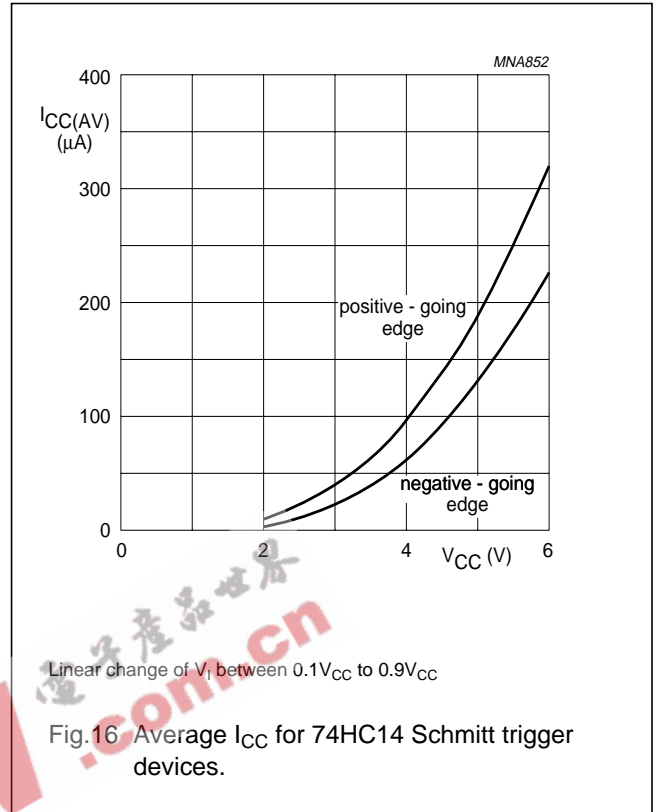

Hex inverting Schmitt trigger

74HC14; 74HCT14

PACKAGE OUTLINES

SO14: plastic small outline package; 14 leads; body width 3.9 mm

SOT108-1

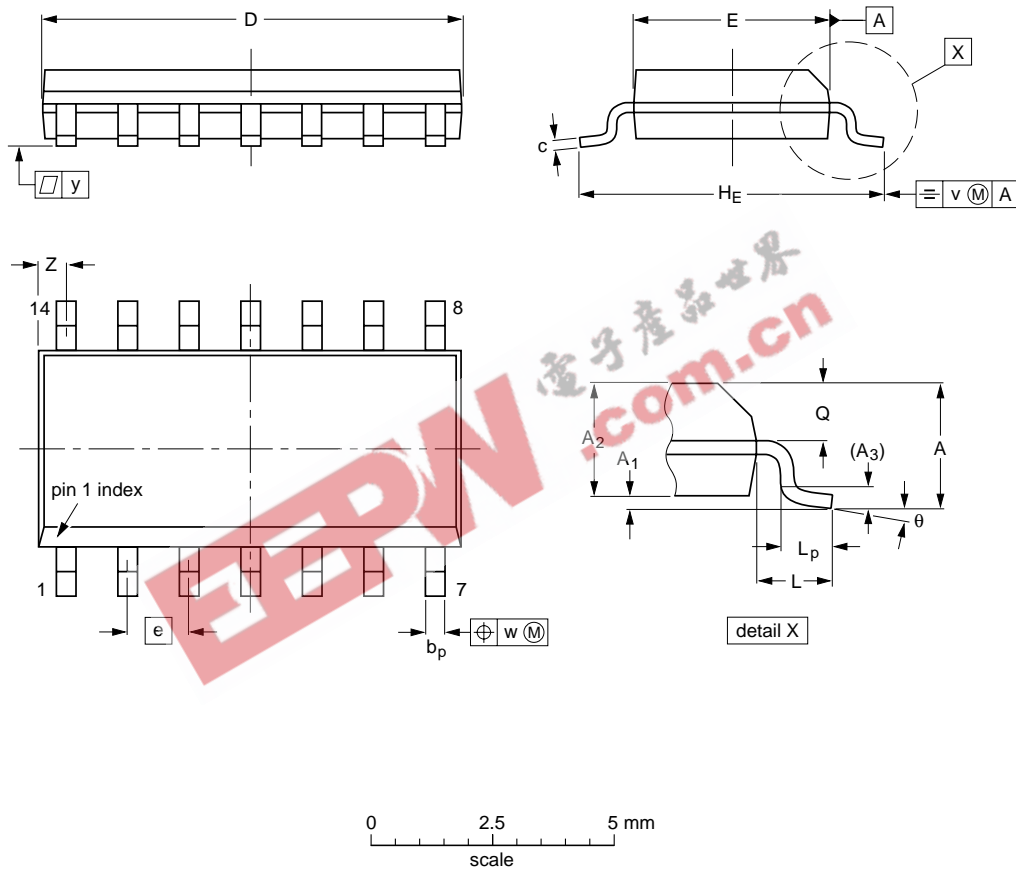

DIMENSIONS (inch dimensions are derived from the original mm dimensions)

UNIT	A max.	A ₁	A ₂	A ₃	b _p	c	D ⁽¹⁾	E ⁽¹⁾	e	H _E	L	L _p	Q	v	w	y	z ⁽¹⁾	θ
mm	1.75	0.25 0.10	1.45 1.25	0.25	0.49 0.36	0.25 0.19	8.75 8.55	4.0 3.8	1.27	6.2 5.8	1.05	1.0 0.4	0.7 0.6	0.25	0.25	0.1	0.7 0.3	8° 0°
inches	0.069	0.010 0.004	0.057 0.049	0.01	0.019 0.014	0.0100 0.0075	0.35 0.34	0.16 0.15	0.05	0.244 0.228	0.041	0.039 0.016	0.028 0.024	0.01	0.01	0.004	0.028 0.012	

Note

1. Plastic or metal protrusions of 0.15 mm (0.006 inch) maximum per side are not included.

OUTLINE VERSION	REFERENCES			EUROPEAN PROJECTION	ISSUE DATE
	IEC	JEDEC	JEITA		
SOT108-1	076E06	MS-012			99-12-27 03-02-19

Hex inverting Schmitt trigger

74HC14; 74HCT14

DIP14: plastic dual in-line package; 14 leads (300 mil)

SOT27-1

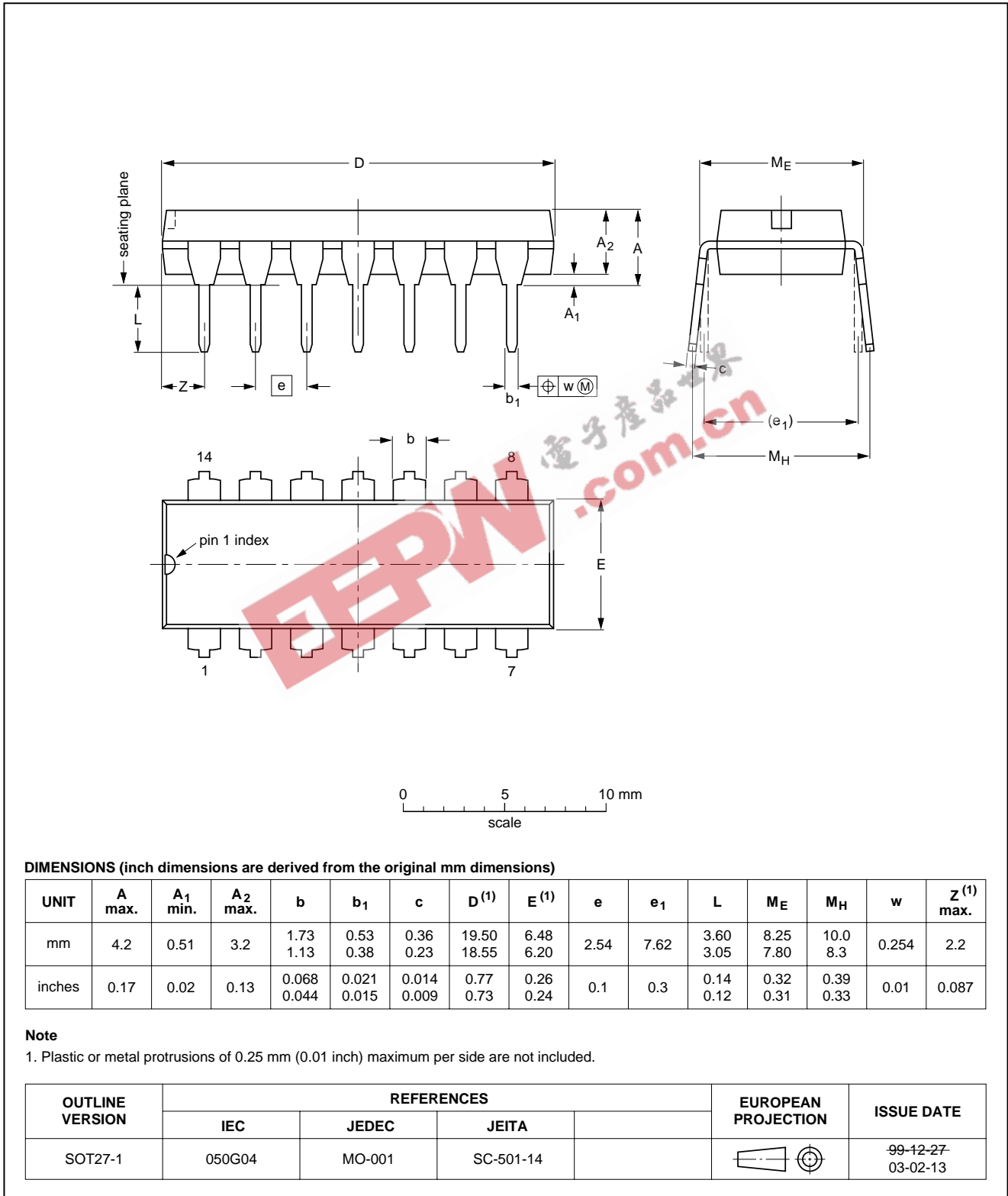

Hex inverting Schmitt trigger

74HC14; 74HCT14

TSSOP14: plastic thin shrink small outline package; 14 leads; body width 4.4 mm

SOT402-1

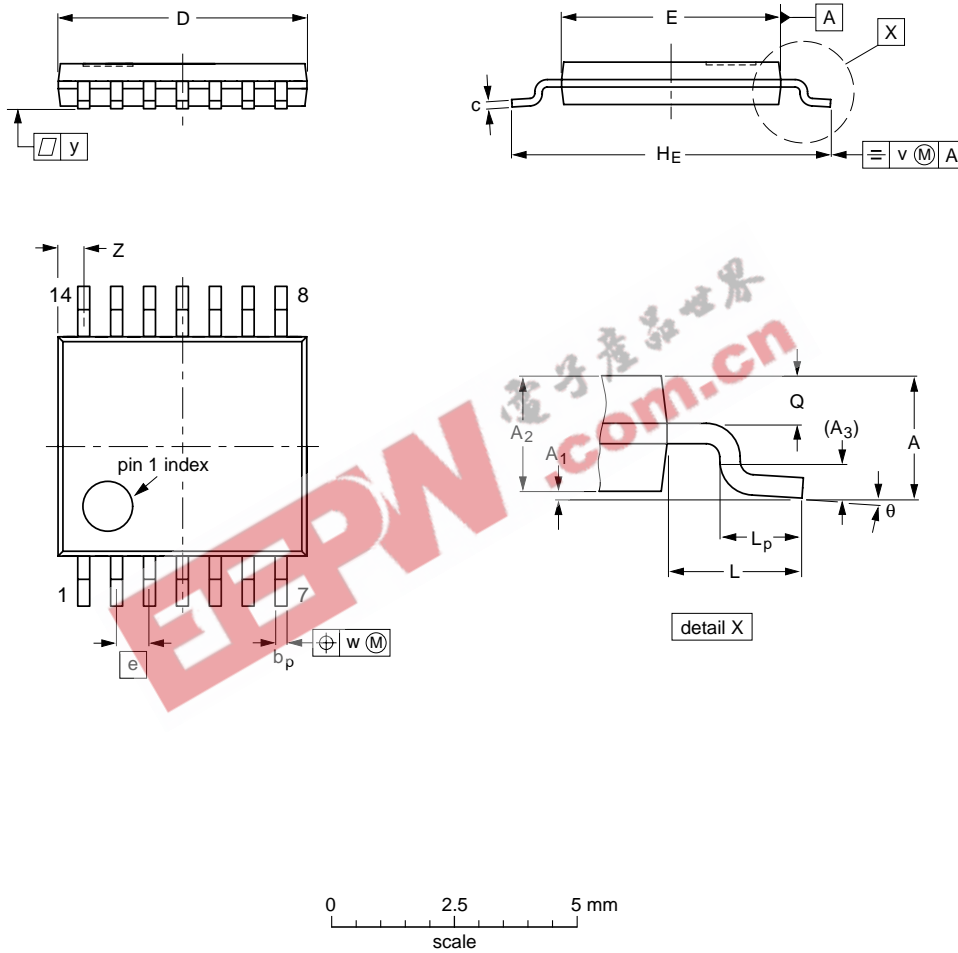

DIMENSIONS (mm are the original dimensions)

UNIT	A max.	A ₁	A ₂	A ₃	b _p	c	D ⁽¹⁾	E ⁽²⁾	e	H _E	L	L _p	Q	v	w	y	Z ⁽¹⁾	θ
mm	1.1	0.15 0.05	0.95 0.80	0.25	0.30 0.19	0.2 0.1	5.1 4.9	4.5 4.3	0.65	6.6 6.2	1	0.75 0.50	0.4 0.3	0.2	0.13	0.1	0.72 0.38	8° 0°

Notes

1. Plastic or metal protrusions of 0.15 mm maximum per side are not included.
2. Plastic interlead protrusions of 0.25 mm maximum per side are not included.

OUTLINE VERSION	REFERENCES				EUROPEAN PROJECTION	ISSUE DATE
	IEC	JEDEC	JEITA			
SOT402-1		MO-153				99-12-27 03-02-18

Hex inverting Schmitt trigger

74HC14; 74HCT14

DHVQFN14: plastic dual in-line compatible thermal enhanced very thin quad flat package; no leads; 14 terminals; body 2.5 x 3 x 0.85 mm

SOT762-1

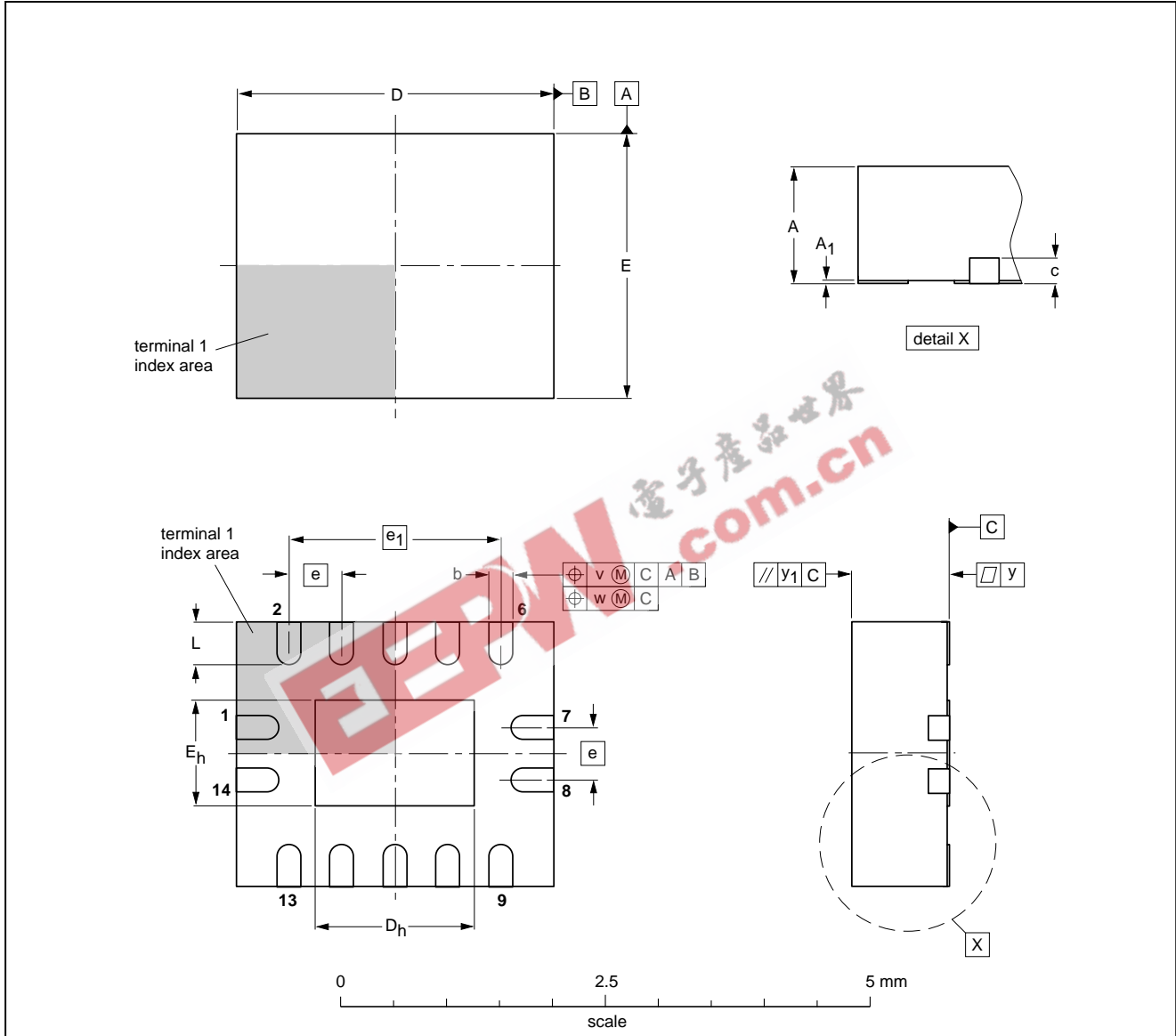

DIMENSIONS (mm are the original dimensions)

UNIT	A ⁽¹⁾ max.	A ₁	b	c	D ⁽¹⁾	D _h	E ⁽¹⁾	E _h	e	e ₁	L	v	w	y	y ₁
mm	1	0.05 0.00	0.30 0.18	0.2	3.1 2.9	1.65 1.35	2.6 2.4	1.15 0.85	0.5	2	0.5 0.3	0.1	0.05	0.05	0.1

Note

1. Plastic or metal protrusions of 0.075 mm maximum per side are not included.

OUTLINE VERSION	REFERENCES			EUROPEAN PROJECTION	ISSUE DATE
	IEC	JEDEC	JEITA		
SOT762-1	---	MO-241	---		02-10-17 03-01-27

Hex inverting Schmitt trigger

74HC14; 74HCT14

DATA SHEET STATUS

LEVEL	DATA SHEET STATUS ⁽¹⁾	PRODUCT STATUS ⁽²⁾⁽³⁾	DEFINITION
I	Objective data	Development	This data sheet contains data from the objective specification for product development. Philips Semiconductors reserves the right to change the specification in any manner without notice.
II	Preliminary data	Qualification	This data sheet contains data from the preliminary specification. Supplementary data will be published at a later date. Philips Semiconductors reserves the right to change the specification without notice, in order to improve the design and supply the best possible product.
III	Product data	Production	This data sheet contains data from the product specification. Philips Semiconductors reserves the right to make changes at any time in order to improve the design, manufacturing and supply. Relevant changes will be communicated via a Customer Product/Process Change Notification (CPCN).

Notes

1. Please consult the most recently issued data sheet before initiating or completing a design.
2. The product status of the device(s) described in this data sheet may have changed since this data sheet was published. The latest information is available on the Internet at URL <http://www.semiconductors.philips.com>.
3. For data sheets describing multiple type numbers, the highest-level product status determines the data sheet status.

DEFINITIONS

Short-form specification — The data in a short-form specification is extracted from a full data sheet with the same type number and title. For detailed information see the relevant data sheet or data handbook.

Limiting values definition — Limiting values given are in accordance with the Absolute Maximum Rating System (IEC 60134). Stress above one or more of the limiting values may cause permanent damage to the device. These are stress ratings only and operation of the device at these or at any other conditions above those given in the Characteristics sections of the specification is not implied. Exposure to limiting values for extended periods may affect device reliability.

Application information — Applications that are described herein for any of these products are for illustrative purposes only. Philips Semiconductors make no representation or warranty that such applications will be suitable for the specified use without further testing or modification.

DISCLAIMERS

Life support applications — These products are not designed for use in life support appliances, devices, or systems where malfunction of these products can reasonably be expected to result in personal injury. Philips Semiconductors customers using or selling these products for use in such applications do so at their own risk and agree to fully indemnify Philips Semiconductors for any damages resulting from such application.

Right to make changes — Philips Semiconductors reserves the right to make changes in the products - including circuits, standard cells, and/or software - described or contained herein in order to improve design and/or performance. When the product is in full production (status 'Production'), relevant changes will be communicated via a Customer Product/Process Change Notification (CPCN). Philips Semiconductors assumes no responsibility or liability for the use of any of these products, conveys no licence or title under any patent, copyright, or mask work right to these products, and makes no representations or warranties that these products are free from patent, copyright, or mask work right infringement, unless otherwise specified.

Philips Semiconductors – a worldwide company

Contact information

For additional information please visit <http://www.semiconductors.philips.com>. Fax: +31 40 27 24825
For sales offices addresses send e-mail to: sales.addresses@www.semiconductors.philips.com.

EEPW.com.cn 电子世界

© Koninklijke Philips Electronics N.V. 2003

SCA75

All rights are reserved. Reproduction in whole or in part is prohibited without the prior written consent of the copyright owner.

The information presented in this document does not form part of any quotation or contract, is believed to be accurate and reliable and may be changed without notice. No liability will be accepted by the publisher for any consequence of its use. Publication thereof does not convey nor imply any license under patent- or other industrial or intellectual property rights.

Printed in The Netherlands

613508/03/pp23

Date of release: 2003 Oct 30

Document order number: 9397 750 10497

Let's make things better.

**Philips
Semiconductors**



PHILIPS