

74LCX245

Low Voltage Bidirectional Transceiver with 5V Tolerant Inputs and Outputs

General Description

The LCX245 contains eight non-inverting bidirectional buffers with 3-STATE outputs and is intended for bus oriented applications. The device is designed for low voltage (2.5V and 3.3V) V_{CC} applications with capability of interfacing to a 5V signal environment. The T/\bar{R} input determines the direction of data flow through the device. The \overline{OE} input disables both the A and B ports by placing them in a high impedance state.

The LCX245 is fabricated with an advanced CMOS technology to achieve high speed operation while maintaining CMOS low power dissipation.

Features

- 5V tolerant inputs and outputs
- 2.3V to 3.6V V_{CC} specifications provided
- 7.0 ns t_{PD} max ($V_{CC} = 3.3V$), 10 μA I_{CC} max
- Power down high impedance inputs and outputs
- Supports live insertion/withdrawal (Note 1)
- ± 24 mA output drive ($V_{CC} = 3.0V$)
- Implements patented noise/EMI reduction circuitry
- Latch-up performance exceeds 500 mA
- ESD performance:
 - Human body model > 2000V
 - Machine model > 200V
- Leadless DQFN Pb-Free package

Note 1: To ensure the high-impedance state during power up or down, \overline{OE} should be tied to V_{CC} through a pull-up resistor: the minimum value or the resistor is determined by the current-sourcing capability of the driver.

Ordering Code:

Order Number	Package Number	Package Description
74LCX245WM (Note 2)	M20B	20-Lead Small Outline Integrated Circuit (SOIC), JEDEC MS-013, 0.300" Wide
74LCX245WMX_NL (Note 4)	M20B	Pb-Free 20-Lead Small Outline Integrated Circuit (SOIC), JEDEC MS-013, 0.300" Wide
74LCX245SJ (Note 2)	M20D	Pb-Free 20-Lead Small Outline Package (SOP), EIAJ TYPE II, 5.3mm Wide
74LCX245BQX (Note 3)	MLP020B	Pb-Free 20-Terminal Depopulated Quad Very-Thin Flat Pack No Leads (DQFN), JEDEC MO-241, 2.5 x 4.5mm
74LCX245MSA (Note 2)	MSA20	20-Lead Shrink Small Outline Package (SSOP), JEDEC MO-150, 5.3mm Wide
74LCX245MTC (Note 2)	MTC20	20-Lead Thin Shrink Small Outline Package (TSSOP), JEDEC MO-153, 4.4mm Wide
74LCX245MTCX_NL (Note 4)	MTC20	Pb-Free 20-Lead Thin Shrink Small Outline Package (TSSOP), JEDEC MO-153, 4.4mm Wide

Pb-Free package per JEDEC J-STD-020B.

Note 2: Devices also available in Tape and Reel. Specify by appending the suffix letter "X" to the ordering code.

Note 3: DQFN package available in Tape and Reel only.

Note 4: "_NL" indicates Pb-Free package (per JEDEC J-STD-020B). Device available in Tape and Reel only.

Logic Symbol

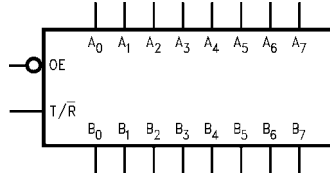

Pin Descriptions

Pin Names	Description
\overline{OE}	Output Enable Input
T/\overline{R}	Transmit/Receive Input
A_0-A_7	Side A Inputs or 3-STATE Outputs
B_0-B_7	Side B Inputs or 3-STATE Outputs

Truth Table

Inputs		Outputs
\overline{OE}	T/\overline{R}	
L	L	Bus $B_0 - B_7$ Data to Bus $A_0 - A_7$
L	H	Bus $A_0 - A_7$ Data to Bus $B_0 - B_7$
H	X	HIGH Z State on $A_0 - A_7, B_0 - B_7$ (Note 5)

H = HIGH Voltage Level
 L = LOW Voltage Level
 X = Immaterial
 Z = High Impedance

Note 5: Unused bus terminals during HIGH Z State must be held HIGH or LOW.

Connection Diagrams

Pin Assignments for SOIC, SOP, SSOP, and TSSOP

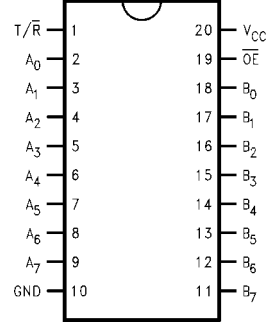

Pin Assignment for DQFN

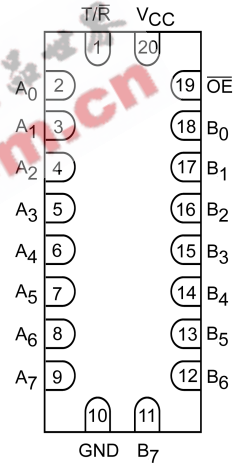

(Top Through View)

Logic Diagram

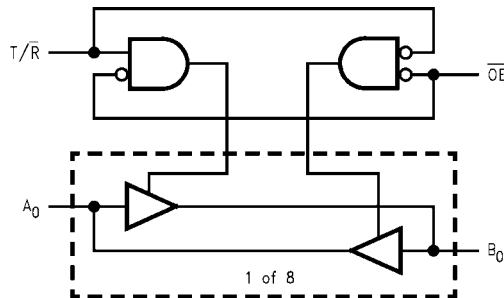

Absolute Maximum Ratings (Note 6)				
Symbol	Parameter	Value	Conditions	Units
V _{CC}	Supply Voltage	-0.5 to +7.0		V
V _I	DC Input Voltage	-0.5 to +7.0		V
V _O	DC Output Voltage	-0.5 to +7.0	Output in 3-STATE	V
		-0.5 to V _{CC} + 0.5	Output in HIGH or LOW State (Note 7)	
I _{IK}	DC Input Diode Current	-50	V _I < GND	mA
I _{OK}	DC Output Diode Current	-50	V _O < GND	mA
		+50	V _O > V _{CC}	
I _O	DC Output Source/Sink Current	±50		mA
I _{CC}	DC Supply Current per Supply Pin	±100		mA
I _{GND}	DC Ground Current per Ground Pin	±100		mA
T _{STG}	Storage Temperature	-65 to +150		°C

Recommended Operating Conditions (Note 8)					
Symbol	Parameter	Min	Max	Units	
V _{CC}	Supply Voltage	Operating	2.0	3.6	V
		Data Retention	1.5	3.6	
V _I	Input Voltage	0	5.5	V	
V _O	Output Voltage	HIGH or LOW State	0	V _{CC}	V
		3-STATE	0	5.5	
I _{OH} /I _{OL}	Output Current	V _{CC} = 3.0V to 3.6V		±24	mA
		V _{CC} = 2.7V to 3.0V		±12	
		V _{CC} = 2.3V to 2.7V		±8	
T _A	Free-Air Operating Temperature	-40	85	°C	
Δt/ΔV	Input Edge Rate, V _{IN} = 0.8V to 2.0V, V _{CC} = 3.0V	0	10	ns/V	

Note 6: The Absolute Maximum Ratings are those values beyond which the safety of the device cannot be guaranteed. The device should not be operated at these limits. The parametric values defined in the Electrical Characteristics tables are not guaranteed at the Absolute Maximum Ratings. The "Recommended Operating Conditions" table will define the conditions for actual device operation.

Note 7: I_O Absolute Maximum Rating must be observed.

Note 8: Unused inputs or I/O pins must be held HIGH or LOW. They may not float.

DC Electrical Characteristics

Symbol	Parameter	Conditions	V _{CC} (V)	T _A = -40°C to +85°C		Units
				Min	Max	
V _{IH}	HIGH Level Input Voltage		2.3 to 2.7	1.7		V
			2.7 to 3.6	2.0		
V _{IL}	LOW Level Input Voltage		2.3 to 2.7		0.7	V
			2.7 to 3.6		0.8	
V _{OH}	HIGH Level Output Voltage	I _{OH} = -100 μA	2.3 to 3.6	V _{CC} - 0.2		V
		I _{OH} = -8 mA	2.3	1.8		
		I _{OH} = -12 mA	2.7	2.2		
		I _{OH} = -18 mA	3.0	2.4		
		I _{OH} = -24 mA	3.0	2.2		
V _{OL}	LOW Level Output Voltage	I _{OL} = 100 μA	2.3 to 3.6		0.2	V
		I _{OL} = 8 mA	2.3		0.6	
		I _{OL} = 12 mA	2.7		0.4	
		I _{OL} = 16 mA	3.0		0.4	
		I _{OL} = 24 mA	3.0		0.55	
I _I	Input Leakage Current	0 ≤ V _I ≤ 5.5V	2.3 to 3.6		±5.0	μA
I _{OZ}	3-STATE I/O Leakage	0 ≤ V _O ≤ 5.5V V _I = V _{IH} or V _{IL}	2.3 to 3.6		±5.0	μA
I _{OFF}	Power-Off Leakage Current	V _I or V _O = 5.5V	0		10	μA

DC Electrical Characteristics (Continued)								
Symbol	Parameter	Conditions	V _{CC} (V)	T _A = -40°C to +85°C		Units		
				Min	Max			
I _{CC}	Quiescent Supply Current	V _I = V _{CC} or GND	2.3 to 3.6		10	μA		
		3.6V ≤ V _I , V _O ≤ 5.5V (Note 9)	2.3 to 3.6		±10			
ΔI _{CC}	Increase in I _{CC} per Input	V _{IH} = V _{CC} - 0.6V	2.3 to 3.6		500	μA		
Note 9: Outputs disabled or 3-STATE only.								
AC Electrical Characteristics								
Symbol	Parameter	T _A = -40°C to +85°C, R _L = 500Ω						Units
		V _{CC} = 3.3V ± 0.3V		V _{CC} = 2.7V		V _{CC} = 2.5V ± 0.2V		
		C _L = 50 pF		C _L = 50 pF		C _L = 30 pF		
		Min	Max	Min	Max	Min	Max	
t _{PHL}	Propagation Delay	1.5	7.0	1.5	8.0	1.5	8.4	ns
t _{PLH}	A _n to B _n or B _n to A _n	1.5	7.0	1.5	8.0	1.5	8.4	
t _{PZL}	Output Enable Time	1.5	8.5	1.5	9.5	1.5	10.5	ns
t _{PZH}	Output Disable Time	1.5	8.5	1.5	9.5	1.5	10.5	
t _{PLZ}	Output Skew (Note 10)	1.5	7.5	1.5	8.5	1.5	9.0	ns
t _{PHZ}		1.5	7.5	1.5	8.5	1.5	9.0	
t _{OSSL}	Output to Output Skew (Note 10)		1.0					ns
t _{OSLH}			1.0					
Note 10: Skew is defined as the absolute value of the difference between the actual propagation delay for any two separate outputs of the same device. The specification applies to any outputs switching in the same direction, either HIGH-to-LOW (t _{OSSL}) or LOW-to-HIGH (t _{OSLH}).								
Dynamic Switching Characteristics								
Symbol	Parameter	Conditions	V _{CC} (V)	T _A = 25°C		Units		
				Typical				
V _{OLP}	Quiet Output Dynamic Peak V _{OL}	C _L = 50 pF, V _{IH} = 3.3V, V _{IL} = 0V C _L = 30 pF, V _{IH} = 2.5V, V _{IL} = 0V	3.3 2.5	0.8 0.6		V		
V _{OLV}	Quiet Output Dynamic Valley V _{OL}	C _L = 50 pF, V _{IH} = 3.3V, V _{IL} = 0V C _L = 30 pF, V _{IH} = 2.5V, V _{IL} = 0V	3.3 2.5	-0.8 -0.6		V		
Capacitance								
Symbol	Parameter	Conditions	Typical	Units				
C _{IN}	Input Capacitance	V _{CC} = Open, V _I = 0V or V _{CC}	7.0	pF				
C _{I/O}	Input/Output Capacitance	V _{CC} = 3.3V, V _I = 0V or V _{CC}	8.0	pF				
C _{PD}	Power Dissipation Capacitance	V _{CC} = 3.3V, V _I = 0V or V _{CC} , f = 10 MHz	25.0	pF				

AC LOADING and WAVEFORMS Generic for LCX Family

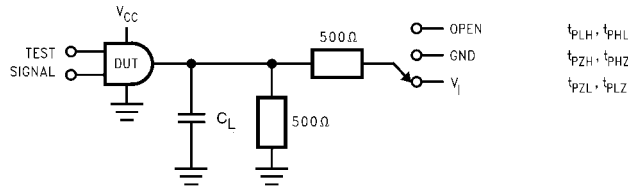
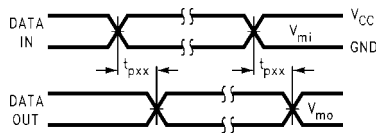
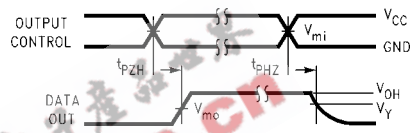

FIGURE 1. AC Test Circuit (C_L includes probe and jig capacitance)

Test	Switch
t_{PLH}, t_{PHL}	Open
t_{PZL}, t_{PLZ}	6V at $V_{CC} = 3.3V \pm 0.3V$ $V_{CC} \times 2$ at $V_{CC} = 2.5V \pm 0.2V$
t_{PZH}, t_{PHZ}	GND



Waveform for Inverting and Non-Inverting Functions



3-STATE Output High Enable and Disable Times for Logic

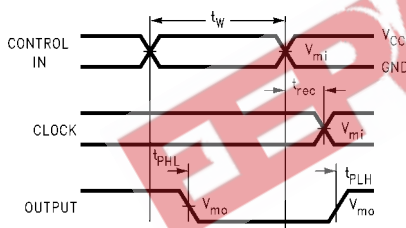

Propagation Delay, Pulse Width and t_{rec} Waveforms

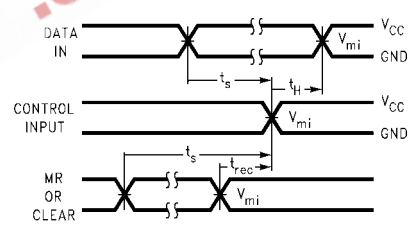

Setup Time, Hold Time and Recovery Time for Logic

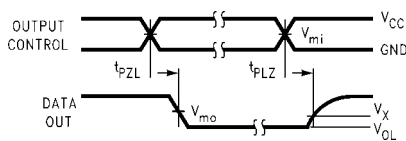

3-STATE Output Low Enable and Disable Times for Logic

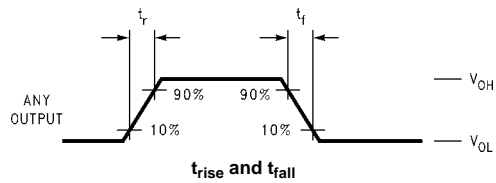

t_{rise} and t_{fall}

FIGURE 2. Waveforms (Input Characteristics; $f = 1MHz, t_r = t_f = 3ns$)

Symbol	V_{CC}		
	$3.3V \pm 0.3V$	2.7V	$2.5V \pm 0.2V$
V_{mi}	1.5V	1.5V	$V_{CC}/2$
V_{mo}	1.5V	1.5V	$V_{CC}/2$
V_x	$V_{OL} + 0.3V$	$V_{OL} + 0.3V$	$V_{OL} + 0.15V$
V_y	$V_{OH} - 0.3V$	$V_{OH} - 0.3V$	$V_{OH} - 0.15V$

Schematic Diagram Generic for LCX Family



Tape and Reel Specification

Tape Format for DQFN

Package Designator	Tape Section	Number Cavities	Cavity Status	Cover Tape Status
BQX	Leader (Start End)	125 (typ)	Empty	Sealed
	Carrier	3000	Filled	Sealed
	Trailer (Hub End)	75 (typ)	Empty	Sealed

TAPE DIMENSIONS inches (millimeters)

PKG.SIZE	DIM.Ao	DIM.Bo	DIM.Ko
3.0 X 3.0	3.3±0.1	3.3±0.1	0.9±0.1
3.5 X 4.5	3.8±0.1	4.8±0.1	0.9±0.1
2.5 X 4.5	2.8±0.1	4.8±0.1	0.9±0.1
2.5 X 3.5	2.8±0.1	3.8±0.1	0.9±0.1
2.5 X 3.0	2.8±0.1	3.3±0.1	0.9±0.1

DIMENSIONS ARE IN MILLIMETERS

FSC MLP/DQFN CARRIER TAPE SPECIFICATIONS

REEL DIMENSIONS inches (millimeters)

Tape Size	A	B	C	D	N	W1	W2
12 mm	13.0 (330.0)	0.059 (1.50)	0.512 (13.00)	0.795 (20.20)	2.165 (55.00)	0.488 (12.4)	0.724 (18.4)

Physical Dimensions inches (millimeters) unless otherwise noted

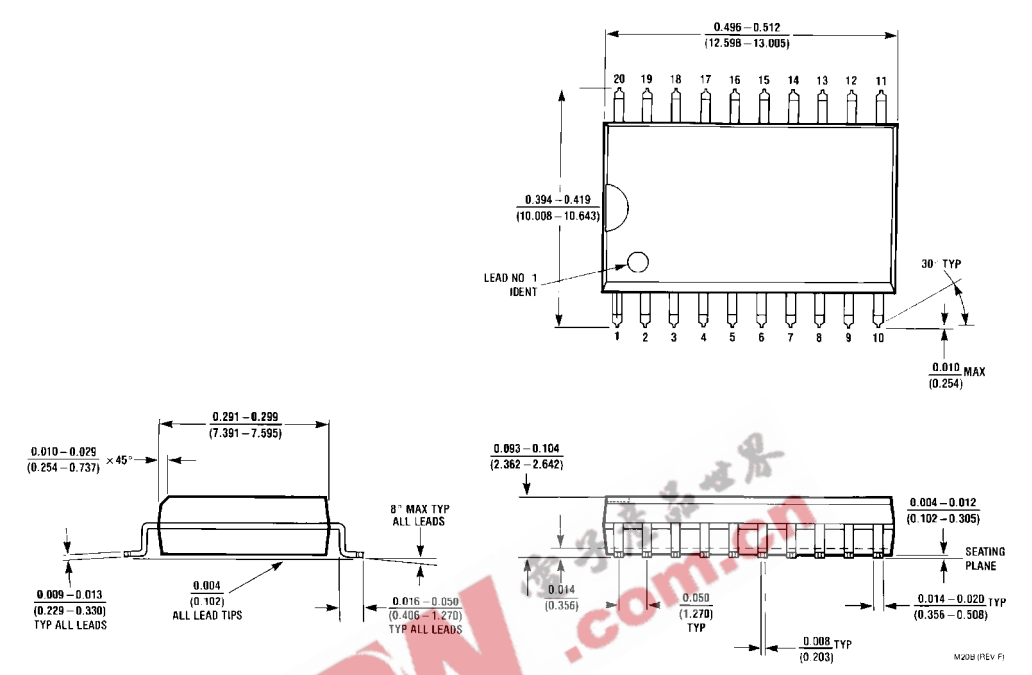

**20-Lead Small Outline Integrated Circuit (SOIC), JEDEC MS-013, 0.300" Wide
Package Number M20B**

Physical Dimensions inches (millimeters) unless otherwise noted (Continued)



LAND PATTERN RECOMMENDATION

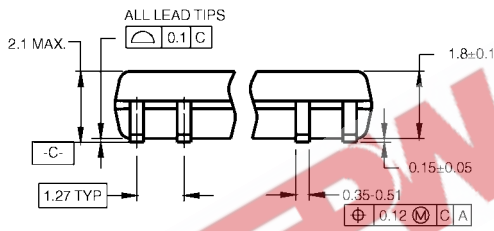

DIMENSIONS ARE IN MILLIMETERS

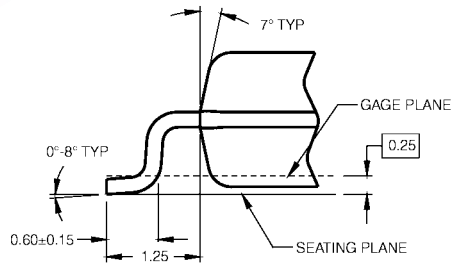
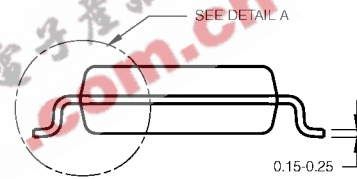

DETAIL A

NOTES:

- A. CONFORMS TO EIAJ EDR-7320 REGISTRATION, ESTABLISHED IN DECEMBER, 1998.
- B. DIMENSIONS ARE IN MILLIMETERS.
- C. DIMENSIONS ARE EXCLUSIVE OF BURRS, MOLD FLASH, AND TIE BAR EXTRUSIONS.

M20DRevB1

**Pb-Free 20-Lead Small Outline Package (SOP), EIAJ TYPE II, 5.3mm Wide
Package Number M20D**

Physical Dimensions inches (millimeters) unless otherwise noted (Continued)

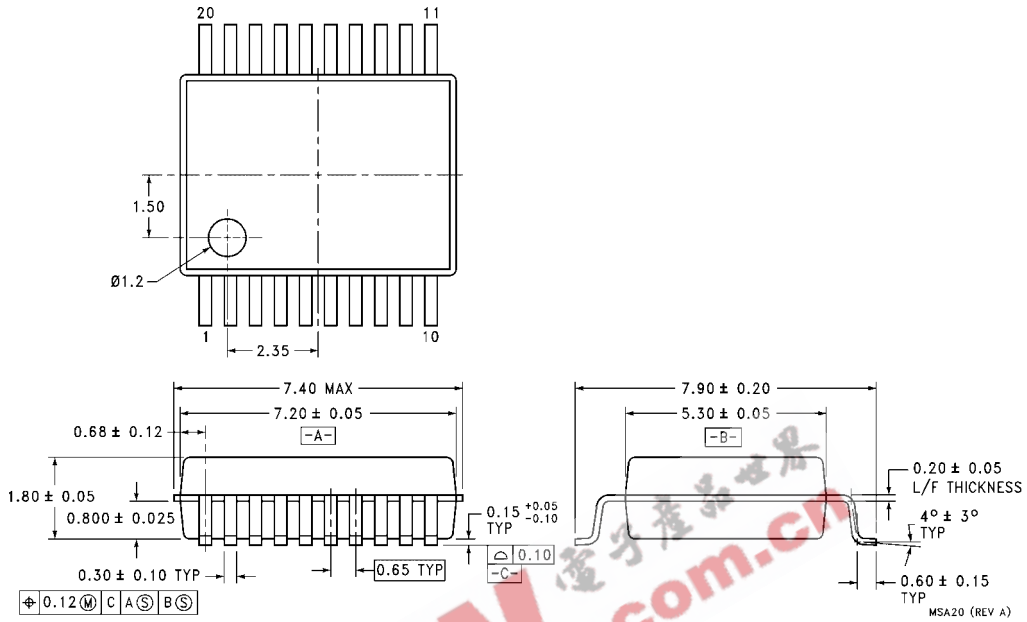

**20-Lead Shrink Small Outline Package (SSOP), JEDEC MO-150, 5.3mm Wide
Package Number MSA20**

Physical Dimensions inches (millimeters) unless otherwise noted (Continued)

NOTES:

- CONFORMS TO JEDEC REGISTRATION MO-153, VARIATION AC, REF NOTE 6, DATE 7/93.
- DIMENSIONS ARE IN MILLIMETERS.
- DIMENSIONS ARE EXCLUSIVE OF BURRS, MOLDS FLASH, AND TIE BAR EXTRUSIONS.
- DIMENSIONS AND TOLERANCES PER ANSI Y14.5M, 1982.

MTC20REV D1

20-Lead Thin Shrink Small Outline Package (TSSOP), JEDEC MO-153, 4.4mm Wide Package Number MTC20

Fairchild does not assume any responsibility for use of any circuitry described, no circuit patent licenses are implied and Fairchild reserves the right at any time without notice to change said circuitry and specifications.

LIFE SUPPORT POLICY

FAIRCHILD'S PRODUCTS ARE NOT AUTHORIZED FOR USE AS CRITICAL COMPONENTS IN LIFE SUPPORT DEVICES OR SYSTEMS WITHOUT THE EXPRESS WRITTEN APPROVAL OF THE PRESIDENT OF FAIRCHILD SEMICONDUCTOR CORPORATION. As used herein:

- Life support devices or systems are devices or systems which, (a) are intended for surgical implant into the body, or (b) support or sustain life, and (c) whose failure to perform when properly used in accordance with instructions for use provided in the labeling, can be reasonably expected to result in a significant injury to the user.
- A critical component in any component of a life support device or system whose failure to perform can be reasonably expected to cause the failure of the life support device or system, or to affect its safety or effectiveness.

www.fairchildsemi.com