

DATA SHEET

EEPW 电子产品世界
.com.cn

74F841/842 Bus interface latches

Product data
Replaces datasheet 74F841/842/843/845/846 of 1999 Jun 23

2004 Jan 23

10-bit bus interface latches, non-inverting/inverting (3-State)

74F841/74F842

FEATURES

- High speed parallel latches
- Extra data width for wide address/data paths or buses carrying parity
- High impedance NPN base input structure minimizes bus loading
- I_{IL} is 20 μ A for minimum bus loading
- Buffered control inputs to reduce AC effects
- Ideal where high speed, light loading, or increased fan-in are required as with MOS microprocessors
- Positive and negative over-shoots are clamped to ground
- 3-State outputs glitch free during power-up and power-down
- 48 mA sink current
- Slim dual in-line 300 mil package
- Broadside pinout

ORDERING INFORMATION

COMMERCIAL RANGE: $V_{CC} = 5 V \pm 10\%$; $T_{amb} = 0^{\circ}C$ to $+70^{\circ}C$

Type number	Package		
	Name	Description	Version
N74F841N, N74F842N	DIP24	plastic dual in-line package; 24 leads (300 mil)	SOT222-1
N74F841D, N74F842D	SO24	plastic small outline package; 24 leads; body width 7.5 mm	SOT137-1

INPUT AND OUTPUT LOADING AND FAN-OUT TABLE

PINS	DESCRIPTION	74F(U.L.) HIGH/LOW	LOAD VALUE HIGH/LOW
Dn	Data inputs	1.0/0.033	20 μ A / 20 μ A
LE	Latch Enable input	1.0/0.033	20 μ A / 20 μ A
\overline{OE}	Output Enable input (active-LOW)	1.0/0.033	20 μ A / 20 μ A
Qn	Data outputs	1200/80	24 mA / 48 mA
\overline{Qn}	Data outputs	1200/80	24 mA / 48 mA

NOTE: One (1.0) FAST Unit Load is defined as: 20 μ A in the HIGH state and 0.6 mA in the LOW state.

DESCRIPTION

The 74F841 and 74F842 bus interface latches are designed to provide extra data width for wider address/data paths of buses carrying parity.

The 74F841 consists of ten D-type latches with 3-State outputs. The flip-flops appear transparent to the data when Latch Enable (LE) is HIGH. This allows asynchronous operation, as the output transition follows the data in transition. On the LE HIGH-to-LOW transition, the data that meets the set-up and hold time is latched.

Data appears on the bus when the Output Enable (\overline{OE}) is LOW. When \overline{OE} is HIGH the output is in the high-impedance state.

The 74F842 is the inverted output version of the 74F841.

TYPE	TYPICAL PROPAGATION DELAY	TYPICAL SUPPLY CURRENT (TOTAL)
74F841, 74F842	5.5 ns	60 mA

10-bit bus interface latches, non-inverting/inverting (3-State)

74F841/74F842

PIN CONFIGURATION for 74F841

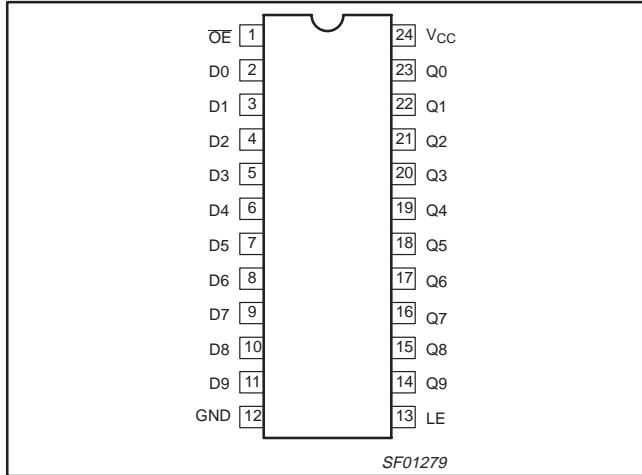

PIN CONFIGURATION for 74F842

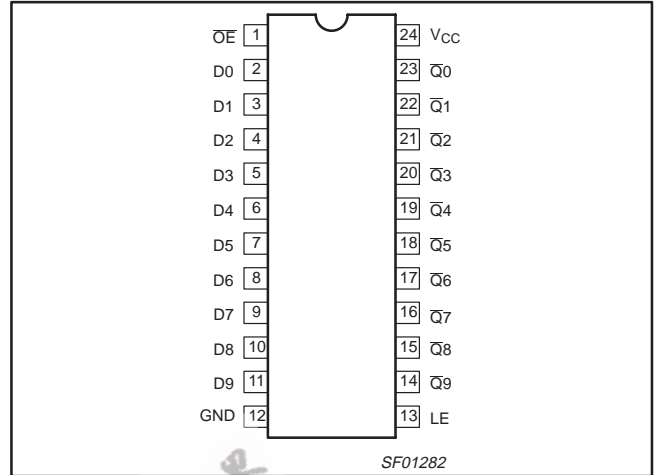

LOGIC SYMBOL for 74F841

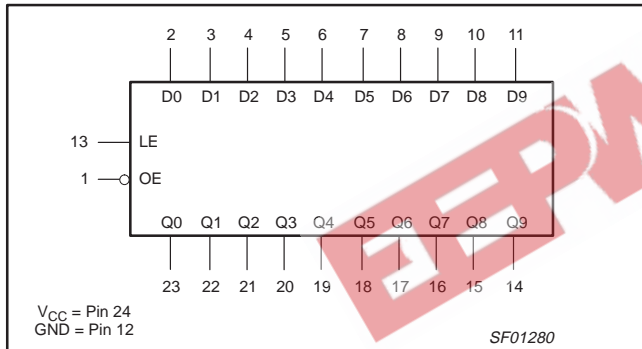

LOGIC SYMBOL for 74F842

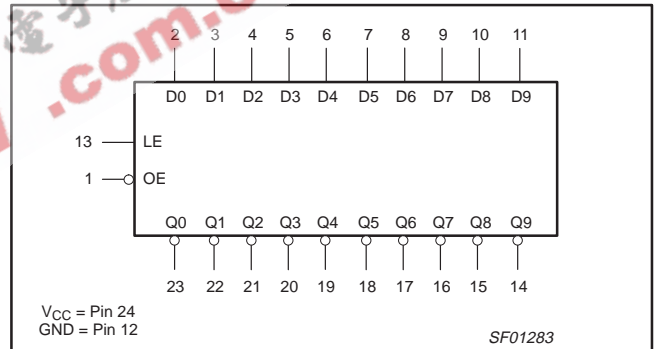

LOGIC SYMBOL (IEEE/IEC) for 74F841

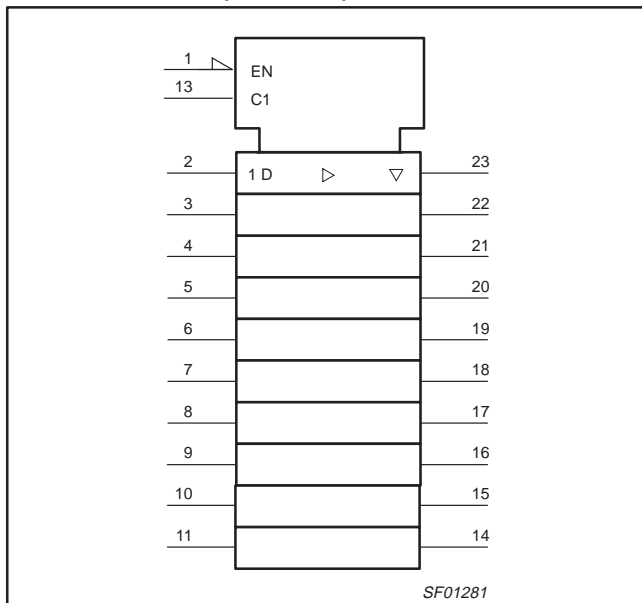

LOGIC SYMBOL (IEEE/IEC) for 74F842

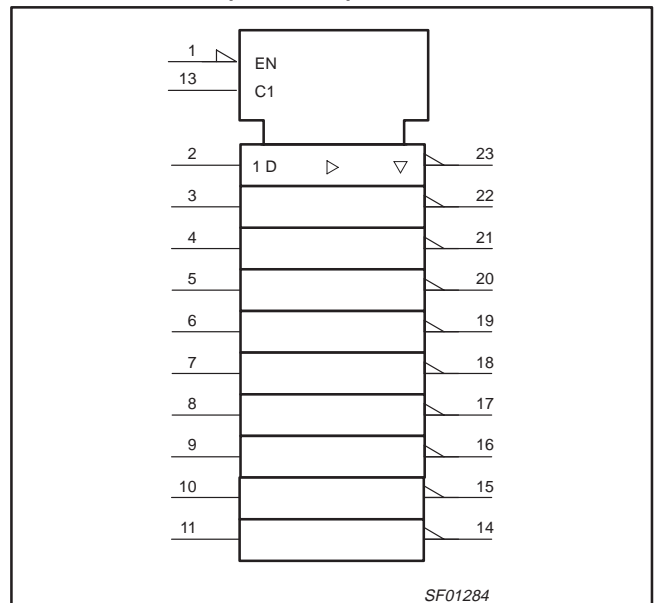

10-bit bus interface latches, non-inverting/inverting (3-State)

74F841/74F842

LOGIC DIAGRAM for 74F841

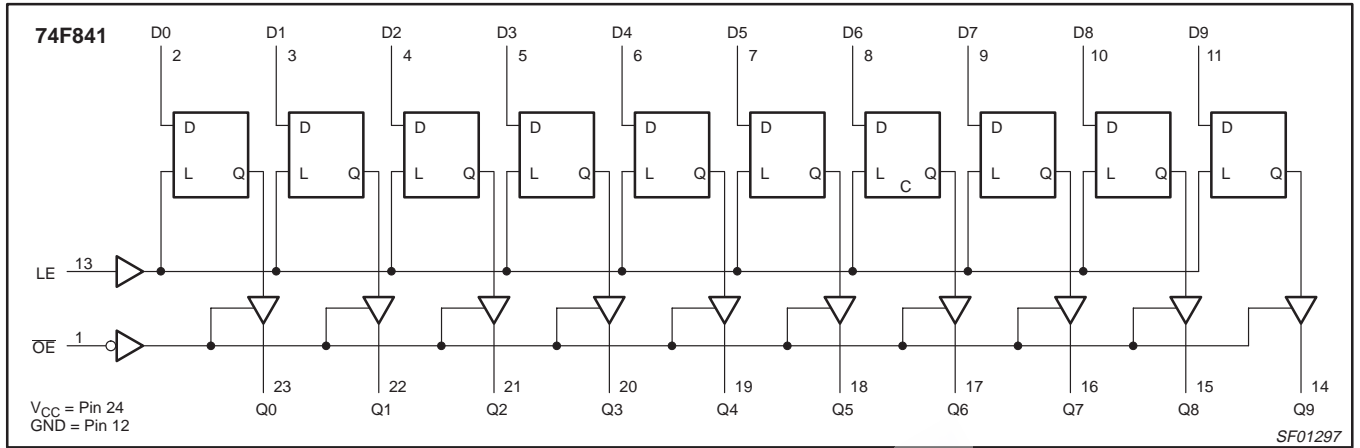

LOGIC DIAGRAM for 74F842

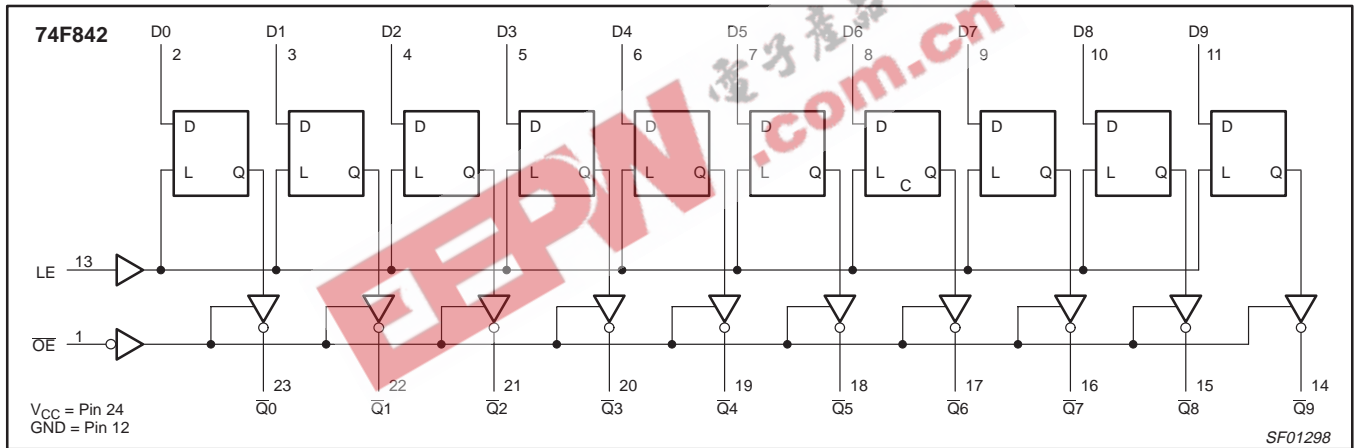

FUNCTION TABLE for 74F841 and 74F842

INPUTS			OUTPUTS		OPERATING MODE
			74F841	74F842	
\overline{OE}	LE	D _n	Q _n	\overline{Q}_n	
L	H	L	L	H	Transparent
L	H	H	H	L	
L	↓	l	L	H	Latched
L	↓	h	H	L	
H	X	X	Z	Z	High Impedance
L	L	X	NC	NC	Hold

H = HIGH voltage level
 L = LOW voltage level
 h = HIGH state one set-up time before the HIGH-to-LOW LE transition
 l = LOW state one set-up time before the HIGH-to-LOW LE transition
 ↓ = HIGH-to-LOW transition
 X = Don't care
 NC = No change
 Z = High impedance "off" state

10-bit bus interface latches, non-inverting/inverting (3-State)

74F841/74F842

ABSOLUTE MAXIMUM RATINGS

Operation beyond the limits set forth in this table may impair the useful life of the device.
Unless otherwise noted these limits are over the operating free-air temperature range.

SYMBOL	PARAMETER	RATING	UNIT
V_{CC}	supply voltage	-0.5 to +7.0	V
V_{IN}	input voltage	-0.5 to +7.0	V
I_{IN}	input current	-30 to +5	mA
V_{OUT}	voltage applied to output in HIGH output state	-0.5 to V_{CC}	V
I_{OUT}	current applied to output in LOW output state	84	mA
T_{amb}	operating free-air temperature range	0 to +70	°C
T_{stg}	storage temperature range	-65 to +150	°C

RECOMMENDED OPERATING CONDITIONS

SYMBOL	PARAMETER	LIMITS			UNIT
		MIN	NOM	MAX	
V_{CC}	supply voltage	4.5	5.0	5.5	V
V_{IH}	HIGH-level input voltage	2.0	-	-	V
V_{IL}	LOW-level input voltage	-	-	0.8	V
I_{IK}	input clamp current	-	-	-18	mA
I_{OH}	HIGH-level output current	-	-	-24	mA
I_{OL}	LOW-level output current	-	-	48	mA
T_{amb}	operating free-air temperature range	0	-	+70	°C

10-bit bus interface latches, non-inverting/inverting
(3-State)

74F841/74F842

DC ELECTRICAL CHARACTERISTICS

Over recommended operating free-air temperature range unless otherwise noted.

SYMBOL	PARAMETER		TEST CONDITIONS ¹		LIMITS			UNIT	
					MIN	TYP ²	MAX		
V _{OH}	HIGH-level output voltage		V _{CC} = MIN; V _{IL} = MAX; V _{IH} = MIN	I _{OH} = -15 mA	± 10%V _{CC}	2.2	-	-	V
					± 5%V _{CC}	2.2	3.3	-	V
				I _{OH} = -24 mA	± 10%V _{CC}	2.0	-	-	V
					± 5%V _{CC}	2.0	-	-	V
V _{OL}	LOW-level output voltage		V _{CC} = MIN; V _{IL} = MAX; V _{IH} = MIN	I _{OL} = 32 mA	± 10%V _{CC}	-	0.38	0.55	V
				I _{OL} = 48 mA	± 5%V _{CC}	-	0.38	0.55	V
V _{IK}	Input clamp voltage		V _{CC} = MIN; I _I = I _{IK}		-	-0.73	-1.2	V	
I _I	Input current at maximum input voltage		V _{CC} = 0 V; V _I = 7.0 V		-	-	100	μA	
I _{IH}	HIGH-level input current		V _{CC} = MAX; V _I = 2.7 V		-	-	20	μA	
I _{IL}	LOW-level input current		V _{CC} = MAX; V _I = 0.5 V		-	-	-20	μA	
I _{OZH}	Off-state output current, HIGH-level voltage applied		V _{CC} = MAX; V _O = 2.7 V		-	-	50	μA	
I _{OZL}	Off-state output current, LOW-level voltage applied		V _{CC} = MAX; V _O = 0.5 V		-	-	-50	μA	
I _{OS}	Short-circuit output current ³		V _{CC} = MAX		-100	-	-225	mA	
I _{CC}	Supply current (total)		74F841	I _{CCH}	V _{CC} = MAX	-	50	65	mA
				I _{CCL}		-	60	80	mA
				I _{CCZ}		-	70	92	mA
			74F842	I _{CCH}		-	40	60	mA
				I _{CCL}		-	65	90	mA
				I _{CCZ}		-	60	90	mA

NOTES:

- For conditions shown as MIN or MAX, use the appropriate value specified under recommended operating conditions for the applicable type.
- All typical values are at V_{CC} = 5 V, T_{amb} = 25 °C.
- Not more than one output should be shorted at a time. For testing I_{OS}, the use of high-speed test apparatus and/or sample-and-hold techniques are preferable in order to minimize internal heating and more accurately reflect operational values. Otherwise, prolonged shorting of a HIGH output may raise the chip temperature well above normal and thereby cause invalid readings in other parameter tests. In any sequence of parameter test, I_{OS} tests should be performed last.

10-bit bus interface latches, non-inverting/inverting
(3-State)

74F841/74F842

AC ELECTRICAL CHARACTERISTICS for 74F841/74F842

SYMBOL	PARAMETER	TEST CONDITION	LIMITS					UNIT	
			T _{amb} = +25 °C V _{CC} = +5.0 V C _L = 50 pF; R _L = 500 Ω			T _{amb} = 0 °C to +70 °C V _{CC} = +5.0 V ± 10% C _L = 50 pF; R _L = 500 Ω			
			MIN	TYP	MAX	MIN	MAX		
t _{PLH} t _{PHL}	Propagation delay Dn to Qn	74F841	Waveform 1, 2	2.0 2.5	4.0 4.5	7.5 7.5	2.0 2.5	8.0 8.0	ns
t _{PLH} t _{PHL}	Propagation delay LE to Qn		Waveform 1, 2	4.5 4.0	6.5 6.0	9.5 9.0	4.0 3.5	10.0 9.5	ns
t _{PLH} t _{PHL}	Propagation delay Dn to Q̄n	74F842	Waveform 1, 2	3.5 3.0	5.5 5.0	8.5 8.0	4.5 4.0	9.0 8.5	ns
t _{PLH} t _{PHL}	Propagation delay LE to Q̄n		Waveform 1, 2	5.0 4.5	7.0 6.5	10.0 9.0	3.0 3.0	10.5 9.5	ns
t _{PZH} t _{PZL}	Output enable time HIGH or LOW-level \overline{OE} to Qn or Q̄n	Waveform 4 Waveform 5		2.5 4.0	4.5 6.0	8.0 9.5	2.0 3.0	8.5 10.5	ns
t _{PHZ} t _{PLZ}	Output disable time HIGH or LOW-level \overline{OE} to Qn or Q̄n	Waveform 4 Waveform 5		1.0 1.0	4.5 5.0	8.0 8.0	1.0 1.0	8.5 8.5	ns

AC SET-UP REQUIREMENTS for 74F841/74F842

SYMBOL	PARAMETER	TEST CONDITION	LIMITS				UNIT	
			T _{amb} = +25 °C V _{CC} = +5.0 V C _L = 50 pF; R _L = 500 Ω		T _{amb} = 0 °C to +70 °C V _{CC} = +5.0 V ± 10% C _L = 50 pF; R _L = 500 Ω			
			MIN	TYP	MIN	MAX		
t _s (H) t _s (L)	Set-up time, HIGH or LOW Dn to LE	Waveform 3	0.0 0.0	– –	1.0 1.0	– –	ns	
t _h (H) t _h (L)	Hold time, HIGH or LOW Dn to LE	74F841	Waveform 3	2.5 3.0	– –	3.0 4.0	– –	ns
t _w (H)	LE pulse width, HIGH		Waveform 3	3.5	–	4.0	–	ns
t _h (H) t _h (L)	Hold time, HIGH or LOW Dn to LE	74F842	Waveform 3	3.0 3.5	– –	3.5 4.5	– –	ns
t _w (H)	LE pulse width, HIGH		Waveform 3	3.0	–	3.0	–	ns

10-bit bus interface latches, non-inverting/inverting (3-State)

74F841/74F842

AC WAVEFORMS

For all waveforms, $V_M = 1.5\text{ V}$.

The shaded areas indicate when the input is permitted to change for predictable output performance.

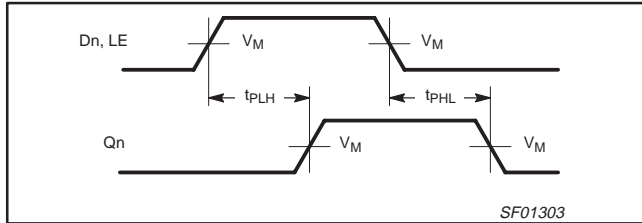

Waveform 1. Propagation delay, non-inverting path

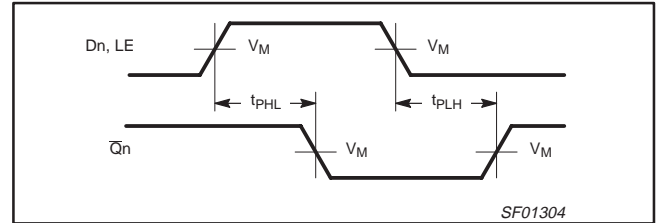

Waveform 2. Propagation delay, inverting path

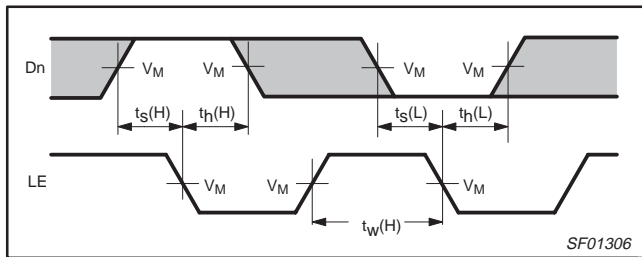

Waveform 3. Data set-up and hold times

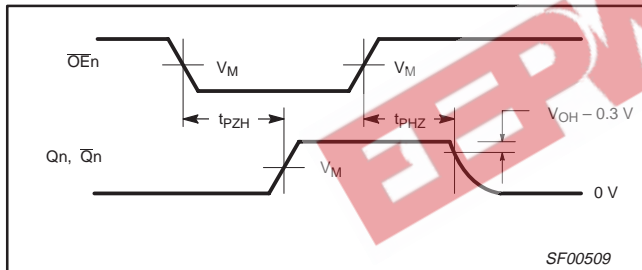

Waveform 4. 3-State Output Enable time to HIGH level and Output Disable time from HIGH level

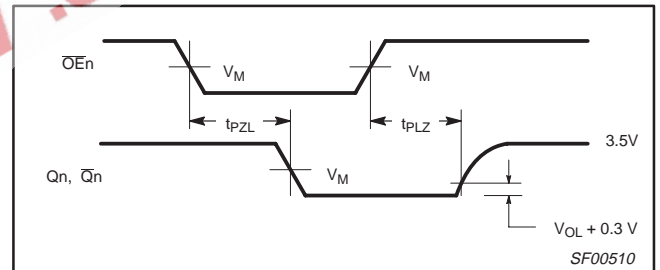

Waveform 5. 3-State Output Enable time to LOW level and Output Disable time from LOW level

10-bit bus interface latches, non-inverting/inverting (3-State)

74F841/74F842

TEST CIRCUIT AND WAVEFORMS

Test Circuit for 3-State Outputs

Input Pulse Definition

SWITCH POSITION

TEST	SWITCH
t_{PLZ}	closed
t_{PZL}	closed
All other	open

DEFINITIONS:

R_L = Load resistor; see AC electrical characteristics for value.

C_L = Load capacitance includes jig and probe capacitance; see AC electrical characteristics for value.

R_T = Termination resistance should be equal to Z_{OUT} of pulse generators.

INPUT PULSE REQUIREMENTS

family	amplitude V_M	rep. rate	t_w	t_{TLH}	t_{THL}
74F	3.0 V	1 MHz	500 ns	2.5 ns	2.5 ns

SF00777

10-bit bus interface latches, non-inverting/inverting
(3-State)

74F841/74F842

DIP24: plastic dual in-line package; 24 leads (300 mil)

SOT222-1

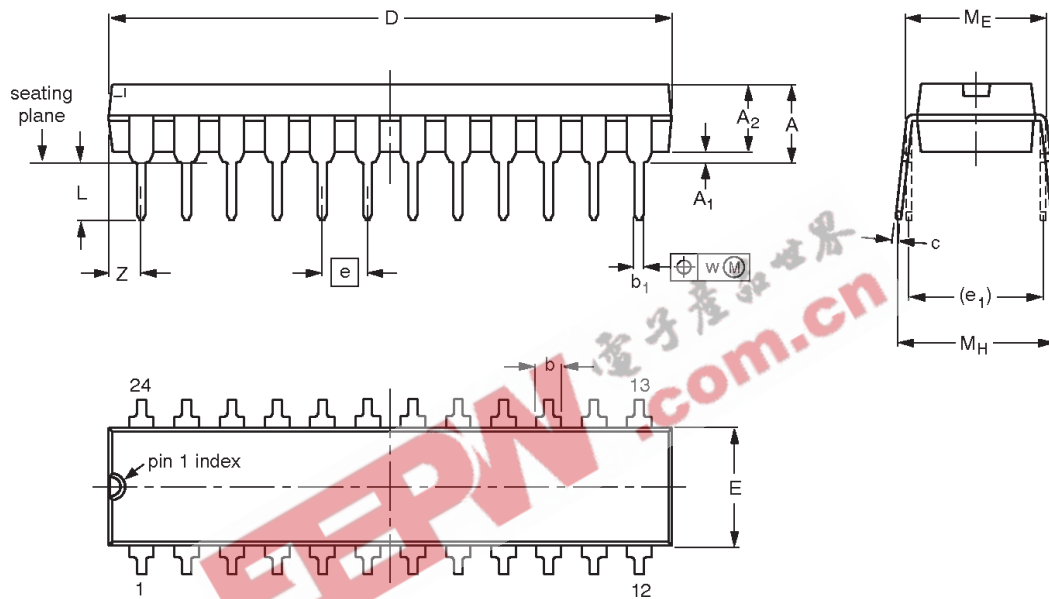

DIMENSIONS (mm dimensions are derived from the original inch dimensions)

UNIT	A max.	A ₁ min.	A ₂ max.	b	b ₁	c	D ⁽¹⁾	E ⁽¹⁾	e	e ₁	L	M _E	M _H	w	Z ⁽¹⁾ max.
mm	4.7	0.38	3.94	1.63 1.14	0.56 0.43	0.36 0.25	31.9 31.5	6.73 6.25	2.54	7.62	3.51 3.05	8.13 7.62	10.03 7.62	0.25	2.05
inches	0.185	0.015	0.155	0.064 0.045	0.022 0.017	0.014 0.010	1.256 1.240	0.265 0.246	0.1	0.3	0.138 0.120	0.32 0.30	0.395 0.300	0.01	0.081

Note

1. Plastic or metal protrusions of 0.25 mm (0.01 inch) maximum per side are not included.

OUTLINE VERSION	REFERENCES				EUROPEAN PROJECTION	ISSUE DATE
	IEC	JEDEC	JEITA			
SOT222-1		MS-001				99-12-27 03-03-12

10-bit bus interface latches, non-inverting/inverting
(3-State)

74F841/74F842

SO24: plastic small outline package; 24 leads; body width 7.5 mm

SOT137-1

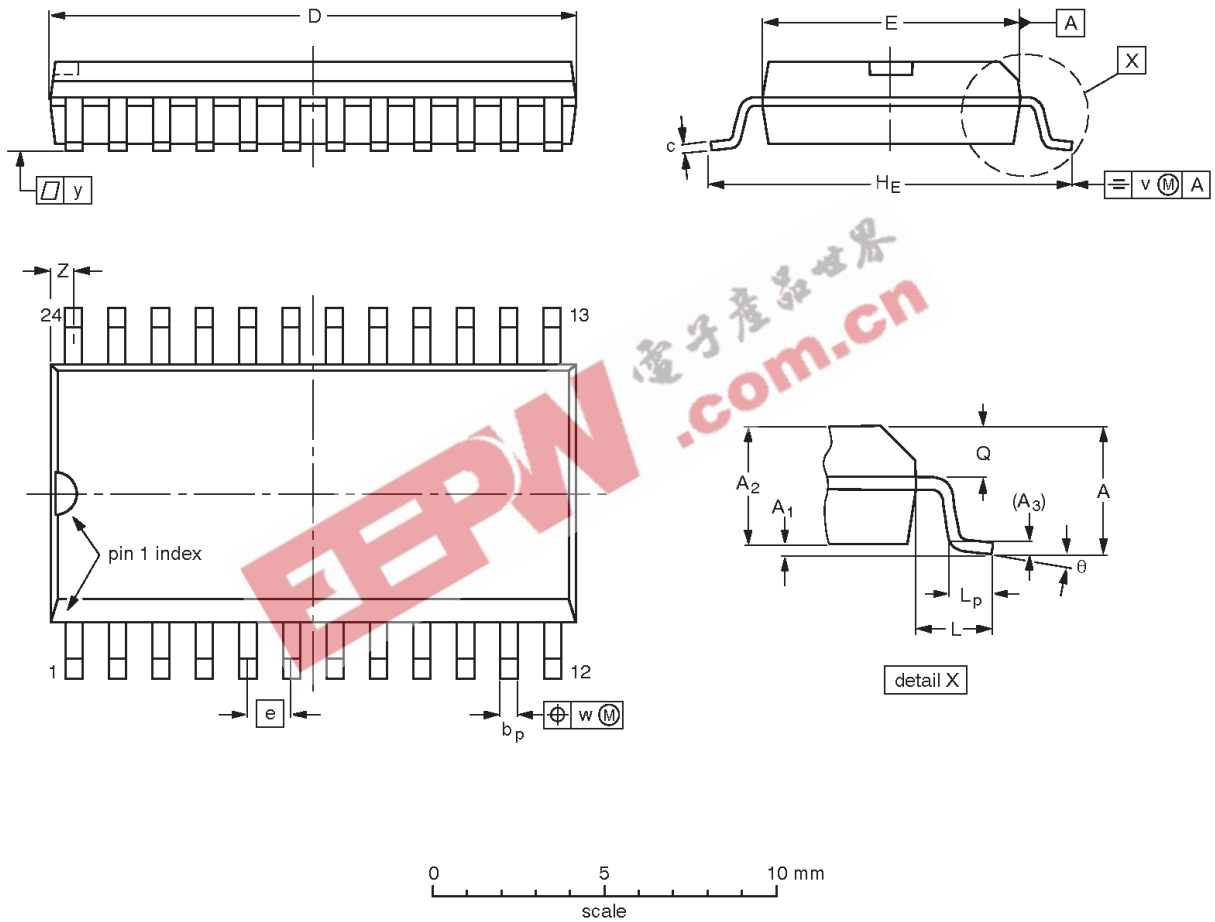

DIMENSIONS (inch dimensions are derived from the original mm dimensions)

UNIT	A max.	A ₁	A ₂	A ₃	b _p	c	D ⁽¹⁾	E ⁽¹⁾	e	H _E	L	L _p	Q	v	w	y	Z ⁽¹⁾	θ
mm	2.65	0.3 0.1	2.45 2.25	0.25	0.49 0.36	0.32 0.23	15.6 15.2	7.6 7.4	1.27	10.65 10.00	1.4	1.1 0.4	1.1 1.0	0.25	0.25	0.1	0.9 0.4	8° 0°
inches	0.1	0.012 0.004	0.096 0.089	0.01	0.019 0.014	0.013 0.009	0.61 0.60	0.30 0.29	0.05	0.419 0.394	0.055	0.043 0.016	0.043 0.039	0.01	0.01	0.004	0.035 0.016	

Note

1. Plastic or metal protrusions of 0.15 mm (0.006 inch) maximum per side are not included.

OUTLINE VERSION	REFERENCES				EUROPEAN PROJECTION	ISSUE DATE
	IEC	JEDEC	JEITA			
SOT137-1	075E05	MS-013				-99-12-27 03-02-19

10-bit bus interface latches, non-inverting/inverting (3-State)

74F841/74F842

REVISION HISTORY

Rev	Date	Description
_4	20040123	Product data (9397 750 12746). ECN 853-1208 A15379 of 22 January 2004. Replaces Product specification 74F841/842/843/845/846_3 dated 1999 Jun 23 (9397 750 06143). Modifications: <ul style="list-style-type: none"> • Delete all references to 74F843, 74F845, 74F846 (products discontinued).
_3	19990623	Product specification (9397 750 06143). ECN 853-1208 21851 of 23 June 1999. Replaces datasheet 74F841/842/843/844/845/846 of 1999 Jan 08.

Data sheet status

Level	Data sheet status ^[1]	Product status ^[2] ^[3]	Definitions
I	Objective data	Development	This data sheet contains data from the objective specification for product development. Philips Semiconductors reserves the right to change the specification in any manner without notice.
II	Preliminary data	Qualification	This data sheet contains data from the preliminary specification. Supplementary data will be published at a later date. Philips Semiconductors reserves the right to change the specification without notice, in order to improve the design and supply the best possible product.
III	Product data	Production	This data sheet contains data from the product specification. Philips Semiconductors reserves the right to make changes at any time in order to improve the design, manufacturing and supply. Relevant changes will be communicated via a Customer Product/Process Change Notification (CPCN).

[1] Please consult the most recently issued data sheet before initiating or completing a design.

[2] The product status of the device(s) described in this data sheet may have changed since this data sheet was published. The latest information is available on the Internet at URL <http://www.semiconductors.philips.com>.

[3] For data sheets describing multiple type numbers, the highest-level product status determines the data sheet status.

Definitions

Short-form specification — The data in a short-form specification is extracted from a full data sheet with the same type number and title. For detailed information see the relevant data sheet or data handbook.

Limiting values definition — Limiting values given are in accordance with the Absolute Maximum Rating System (IEC 60134). Stress above one or more of the limiting values may cause permanent damage to the device. These are stress ratings only and operation of the device at these or at any other conditions above those given in the Characteristics sections of the specification is not implied. Exposure to limiting values for extended periods may affect device reliability.

Application information — Applications that are described herein for any of these products are for illustrative purposes only. Philips Semiconductors make no representation or warranty that such applications will be suitable for the specified use without further testing or modification.

Disclaimers

Life support — These products are not designed for use in life support appliances, devices, or systems where malfunction of these products can reasonably be expected to result in personal injury. Philips Semiconductors customers using or selling these products for use in such applications do so at their own risk and agree to fully indemnify Philips Semiconductors for any damages resulting from such application.

Right to make changes — Philips Semiconductors reserves the right to make changes in the products—including circuits, standard cells, and/or software—described or contained herein in order to improve design and/or performance. When the product is in full production (status 'Production'), relevant changes will be communicated via a Customer Product/Process Change Notification (CPCN). Philips Semiconductors assumes no responsibility or liability for the use of any of these products, conveys no license or title under any patent, copyright, or mask work right to these products, and makes no representations or warranties that these products are free from patent, copyright, or mask work right infringement, unless otherwise specified.

Contact information

For additional information please visit
<http://www.semiconductors.philips.com>. Fax: +31 40 27 24825

© Koninklijke Philips Electronics N.V. 2004
 All rights reserved. Printed in U.S.A.

Date of release: 01-04

For sales offices addresses send e-mail to:
sales.addresses@www.semiconductors.philips.com

Document order number:

9397 750 12746

Let's make things better.