

THICK FILM CHIP RESISTOR ARRAYS

- * Low cost
- * High density packaging
- * Leadless surface mount construction
- * Tape & reel packaging
- * Solder coated nickel barrier pads
- * Isolated and bussed circuits
- * Convex or Concave Termination Options

Chip Array Product Benefits

- * High Density Packaging
 - Up to 30% less space per resistor than 0603 chip resistors
 - Up to 75% less space per resistor than 0805 chip resistors
- * Placement Efficiency
 - Networks require fewer placements than discrete components
 - Larger overall size eases handling compared to discrete components
- * Low Profile
 - Can be used in PCMCIA cards
- * Perfect solution for DRAM series termination or Pull up/down signal bias.

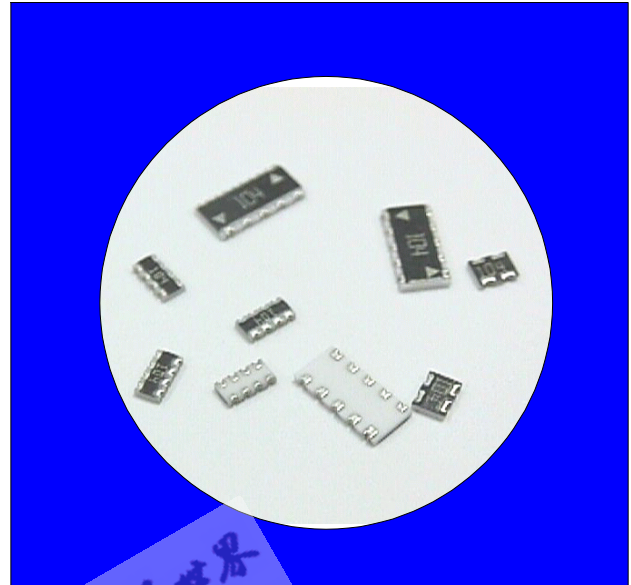

Electrical and Mechanical Specifications

Series	PCB Area (in ²) Per Resistor	Circuit Type	Resistance Range Ohms	70°C Power Per Resistor *	Maximum Operating Voltage
741	.0015	Isolated	10 - 1M	.063W	25V
742	.0037	Isolated	10 - 1M	.063W	50V
743	.0071	Isolated	10 - 1M	.100W	100V
744	.0094	Isolated	10 - 1M	.125W	200V
745	.0058	Bussed	33 - 470K	.063W	50V
746	.0013	Bussed	33 - 100K	.031W	25V

Resistance Tolerance

Standard: $\pm 5\%$ or 0.5 Ohms
 Whichever is greater
 Special: $\pm 2\%$ and $\pm 1\%$

* Note: Total Rated Package Power equals total number of resistors times rated Power Per Resistor

Operating Temperature Range

-55°C to +125°C

Temperature Coefficient (TCR)

Standard ± 200 ppm/°C

Concave Termination -Type C

Convex Termination -Type X

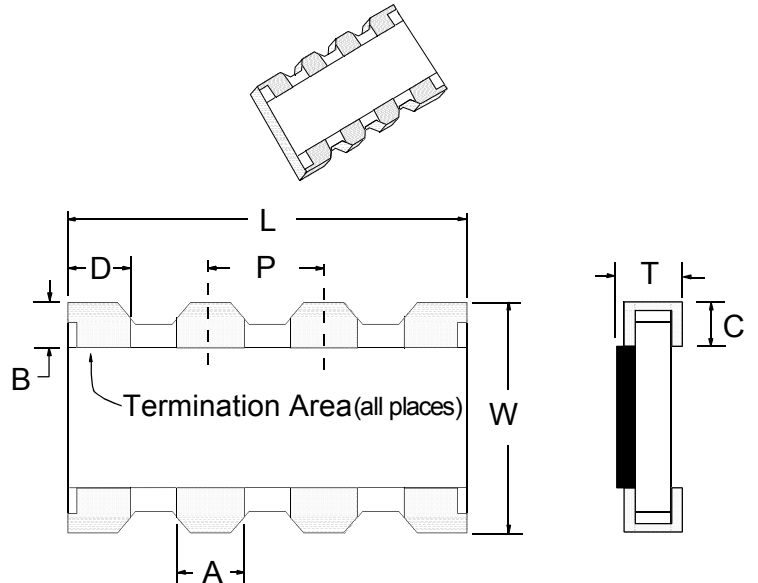
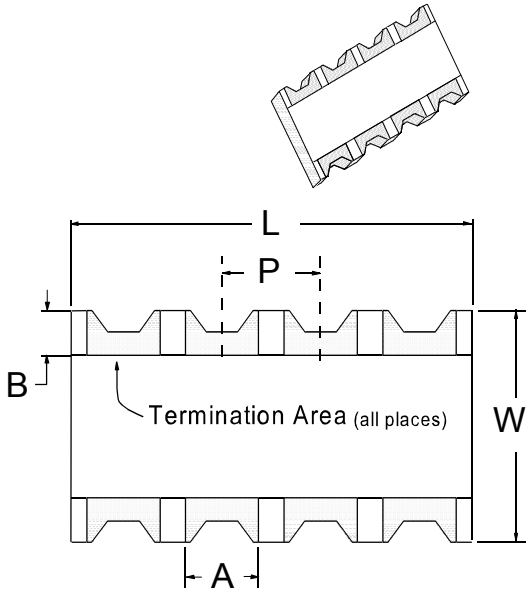

Dimensions: mm
inch

Part Code	# Pads	# Res.	Circuit	L	W	P	T	A	B	C	D
741X043	4	2	Isolated	1.0 ±0.1 .039 ±.004		0.65 ±0.10 .026 ±.004		0.33 ±0.10 .013 ±.004			
741X083	8	4	Isolated	2.0 ±0.1 .079 ±.004	1.0 ±0.1 .039 ±.004	0.50 ±0.1 .020 ±.004	0.35 ±0.10 .014 ±.004	0.20 ±0.15 .008 ±.006	0.20 ±0.10 .008 ±.004	0.38 Max. .015 Max.	N/A
741C083	8	4	Isolated					0.28 ±0.1 .011 ±.004			
741X163	16	8	Isolated	3.8 ±0.1 .150 ±.004	1.6 ±0.1 .063 ±.004		0.45 ±0.10 .020 ±.004	0.30 ±0.1 .012 ±.004	0.30 ±0.1 .012 ±.004	0.30 ±0.1 .012 ±.004	
742C043	4	2	Isolated	1.6 ±0.2 .063 ±.008			0.6 ±0.10 -.25 .024+ .004 -.010			0.4 ±0.15 .016 ±.006	N/A
742X083	8	4	Isolated	3.2 ±0.2 .126 ±.008	1.6 ±0.2 .063 ±.008	0.8 ±0.05 .032 ±.002		0.5 ±0.15 .020 ±.006	0.3 ±0.20 .012 ±.008	0.3 ±0.15 .012 ±.006	
742C083	8	4	Isolated							0.4 ±0.15 .016 ±.006	
742C163	16	8	Isolated	6.4 ±0.2 .252 ±.008					0.4 ±0.15 .016 ±.006		
743C043	4	2	Isolated	2.54 ±0.20 .100 ±.008			0.6 ±0.1 .024 ±.004	0.8 ±0.15 .031 ±.006	0.4 ±0.2 .016 ±.008	0.4 ±0.15 .016 ±.006	N/A
743C083	8	4	Isolated	5.08 ±0.3 .200 ±.012	2.0 ±0.2 .079 ±.008	1.27 ±0.05 .050 ±.002					
744C043	4	2	Isolated	2.54 ±0.20 .100 ±.008			0.6 ±0.1 .024 ±.004	0.9 ±0.15 .035 ±.006	0.5 ±0.2 .020 ±.008	0.5 ±0.15 .020 ±.006	N/A
744C083	8	4	Isolated	5.08 ±0.3 .200 ±.012	3.2 ±0.2 .126 ±.008	1.27 ±0.05 .050 ±.002					
745C101	10	8	Bussed	6.4 ±0.2 .252 ±.008	3.2 ±0.2 .126 ±.008	1.27 ±0.05 .050 ±.002	0.6 ±0.1 .024 ±.004	0.6 ±0.15 .024 ±.006	0.35 ±0.15 .013 ±.006	0.55 ±0.15 .022 ±.006	N/A
745X101	10	8	Bussed	6.4 ±0.2 .252 ±.008	3.2 ±0.2 .126 ±.008	1.27 ±0.05 .050 ±.002	0.6 ±0.1 .024 ±.004	0.9 ±0.15 .035 ±.006	0.5 ±0.2 .020 ±.008	0.5 ±0.15 .020 ±.006	1.1 ±0.15 .043 ±.006
745X102	10	8	Bussed								
746X101	10	8	Bussed	3.3 ±0.1 .130 ±.004	1.65 ±0.15 .065 ±.006	.64 ±0.05 .025 ±.002	0.6 ±0.1 .024 ±.004	0.35 ±0.05 .014 ±.002	0.4 ±0.10 .016 ±.004	0.45 ±0.10 .018 ±.004	0.5 ±0.05 .020 ±.002

Recommended Land Patterns

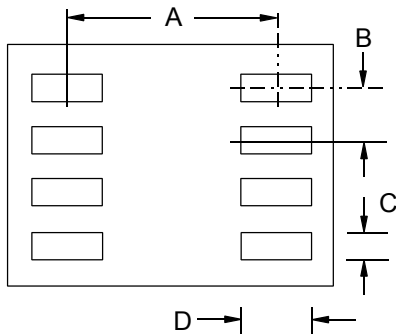

SERIES	DIMENSION mm/in.			
	A	B	C	D
741	1.14 .047	0.50 .020	0.25 .010	0.61 .024
742	1.80 .071	.80 .032	.50 .020	.90 .035
743	1.90 .075	1.27 .050	.80 .032	1.20 .047
744	3.00 .118	1.27 .050	.80 .032	1.30 .051
745	3.00 .118	1.27 .050	.80 .032	1.30 .051
746	1.52 .060	.64 .025	.35 .014	.80 .032

Note: Land Patterns for Concave and Convex termination can be the same.

Standard Packages & Style Codes

Concave Termination

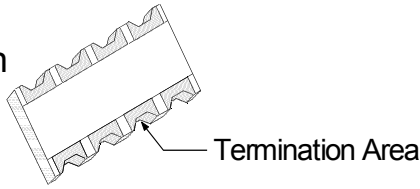

Convex Termination

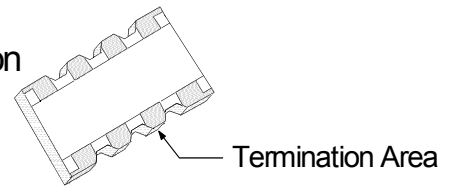

741C083
4 Resistors
8 Terminations

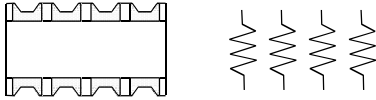

741X043
2 Resistors
4 Terminations

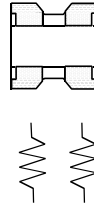

741X083
4 Resistors
8 Terminations

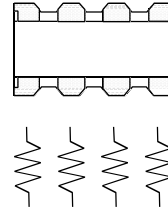

741X163
8 Resistors
16 Terminations

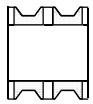
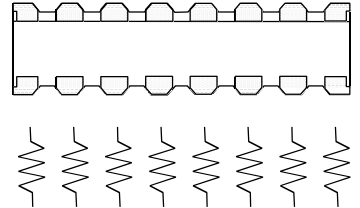

742C043
2 Resistors
4 Terminations

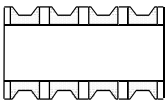

742C083
4 Resistors
8 Terminations

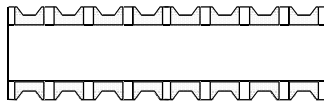

742C163
8 Resistors
16 Terminations

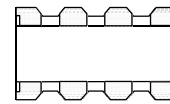

742X083
4 Resistors
8 Terminations

50 mil pitch (1.27mm)

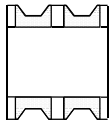

743C043
2 Resistors
4 Terminations

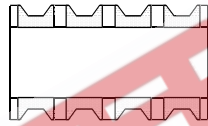

743C083
4 Resistors
8 Terminations

50 mil pitch (1.27mm)

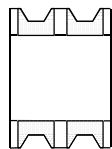

744C043
2 Resistors
4 Terminations

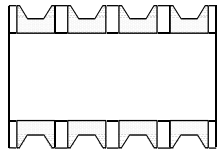

744C083
4 Resistors
8 Terminations

Common Pad Designator

50 mil pitch (1.27mm)

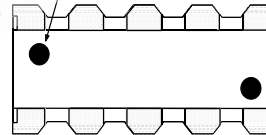

745X101
8 Resistors
10 Terminations

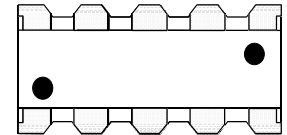

745X102
8 Resistors
10 Terminations

Note: The Marking Concept for Convex and Concave Series 745 is Different.

50 mil pitch (1.27mm)

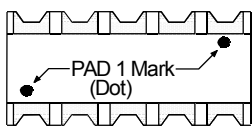

745C101
8 Resistors
10 Terminations

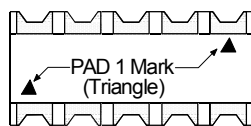

745C102
8 Resistors
10 Terminations

25 mil pitch (.64mm)

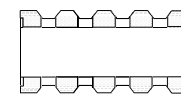

Eight Bussed Resistors in nearly the same space as one 1206 size chip resistor!

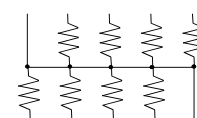

746X101
8 Resistors
10 Terminations

Environmental Performance Specifications

Test	Max. Delta R		Test Description
	741	742-746	
Thermal Cycle	1.0%	1.0%	5 Cycles -55°C to +125°C
Short Time Overload	2.5%	1.0%	2½ X Rated Working Voltage for 5 Seconds
Moisture Resistance	5.0%	2.0%	240 Hours 10% rated load, -10°C to +65°, 90% R.H.
High Temperature Exposure	1.0%	1.0%	1000 Hours, no load, +125°C
Load Life	5.0%	2.0%	1000 Hours @ 70°C, rated load
Resistance to Solder Heat	2.0%	1.0%	10 Seconds @ 260°C solder
Resistance to Solvents			Isopropyl alcohol, Freon TMC
Solderability			RMA Flux, 230°C, 5 Seconds dip, 95% coverage

Standard Resistor Values & EIA Code

Ohms	Code	Ohms	Code	Ohms	Code	Ohms	Code	Ohms	Code	Ohms	Code
0	000	68	680	470	471	3.9K	392	33K	333	270K	274
10	100	75	750	510	511	4.7K	472	39K	393	330K	334
12	120	82	820	560	561	5.1K	512	47K	473	390K	394
15	150	100	101	680	681	5.6K	562	51K	513	470K	474
18	180	110	111	820	821	6.8K	682	56K	563	510K	514
22	220	120	121	1K	102	8.2K	822	68K	683	560K	564
27	270	150	151	1.2K	122	10K	103	82K	823	680K	684
33	330	180	181	1.5K	152	12K	123	100K	104	820K	824
39	390	220	221	1.8K	182	15K	153	120K	124	1M	105
47	470	270	271	2.2K	222	18K	183	150K	154	Series 745 33 to 470KOhm Series 746 33 to 100KOhm	
51	510	330	331	2.7K	272	22K	223	180K	184		
56	560	390	391	3.3K	332	27K	273	220K	224		

Note: 0 Ohm Jumper Resistance < .05 Ohms
Part Code Tolerance = X
Part Marking is "0"

Part Number Code For Ordering

742X083101J

Style Code
See Standard
Package Styles

Resistor Code
3 digit EIA
Shown Above

Tolerance
J = ±5% (Standard)
G = ±2% F = ±1%
X for zero ohm jumper

Notes:

No dashes or spaces in the part number. (Example) 742X083101J
Marking on the Part Includes Resistor Code Only (741C, 742, 743, 744, 745, 746).
No Marking on the Part for 741X Series.

Tape & Reel Information

Style	741X043 741C083 741X083	742C043 741X163	742C083 742X083	742C163	743C043	743C083	744C043	744C083	745C101 745C102	745X101 745X102	746X101
Parts/Reel	10,000	5000	5000	4000	4000	4000	4000	2000	4000	4000	5000
Pitch	2mm	4mm	4mm	4mm	4mm	4mm	4mm	8mm	4mm	4mm	4mm
Carrier Width	8mm	8mm	8mm	12mm	8mm	12mm	8mm	12mm	12mm	12mm	8mm
Material	paper	paper	paper	plastic	plastic	plastic	plastic	plastic	plastic	plastic	paper

Order From:



QS-9000 ★ ISO 9001

Certificate Number: 30599

Your local **CTS REPRESENTATIVE** or **CTS Corporation, Resistor/Electrocomponents**
406 Parr Road, Berne, Indiana 46711 Tel:(260)-589-3111 Fax:(260)-589-3243 <http://www.ctscorp.com>