



### Features

- Mechanically linked contacts meeting IEC 947-5-1-L
- 2...12 poles – all mechanically linked
- Red faceplate for easy identification of safety circuits
- IEC mechanically linked contacts symbol displayed on front
- Double-break contacts to reduce probability of welded contacts
- Visual indication of contact state
- Tamper resistant cover helps prevent changes which could jeopardize safety
- Complete Catalogue number displayed on front
- Ideal for use in safety circuits

### Specifications

Type		700S-P						
Contact Rating Continuous		10 A @ 600V AC / 5 A @ 600V DC						
Ratings	AC	NEMA A600						
	Make/Break	NEMA P600						
Min. Contact Switching Ratings		10V, 50 mA						
DC Switching	Contacts in Series	Volts DC						
		24	64	125	250	500	600	
		1	5A	2.2A	1.1A	0.55A	0.24A	0.2A
		2	10A	10A	5A	2A	0.7A	0.5A
		3	—	—	7A	3A	1.5A	1.0A
4	—	—	10A	5A	2.5A	1.5A		
Contact Electrical Life— Resistive Loads		1.5 mil. ops. at 10A break at 120V AC 14 mil. ops. at 1A break at 120V AC 6 mil. ops. at 1A break at 24V DC						
Coil Voltage Range ❶	AC	85...110%						
	DC	80...110%						
	Battery Charging	85...115%						
Coil Con- sump-tion	AC	Inrush	50 Hz		60 Hz			
		Sealed	132 VA	138 VA	19.3 VA	19 VA		
	DC	Inrush	12.7 W					
		Sealed	12.7 W					
	Mechanically Linked Contacts		All contacts are mechanically linked per IEC 947-5-1 annex L for 2 to 12 poles					
Operating Time	Pick-up	AC – 10...20 ms / DC – 30...50 ms						
	Dropout	AC – 10...20 ms / DC – 20...33 ms						
Mechanical Life		12.5 million operations ❷						
Contact Arrangement		2 to 12 Poles, Double Break Contacts N.O. or N.C. (8 N.C. Maximum)						
Contact Material/Design		Silver Nickel/Bifurcated						
Mounting		Panel mount or mount on 700-MP Rail Horizontal Mounting Recommended						
Temperature	Operating ❸	–20...+65°C (–4...149°F)						
	Storage	–40...+65°C (–40...149°F)						
Wire size per UL/CSA		1X #18 AWG...2X #12 AWG						
Tightening Torque		8...12 lb-in. (0.9...1.4 N•m)						

❶ Coil voltage required for proper operation (percent of rated coil voltage).

❷ 90% of devices are expected to meet or exceed 12.5 million operations, and 50% of devices are expected to meet 20 million operations.

❸ Temperature inside the panel.

# Contactors & Control Relays





## Safety Control Relays

### 700S-P

#### Product Selection

#### Type S-P Control Relays — AC and DC Coil Voltage

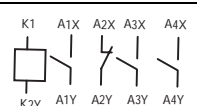
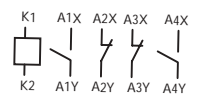
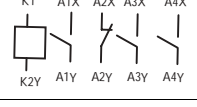
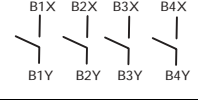
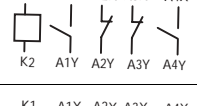
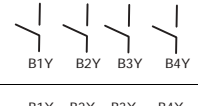
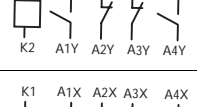
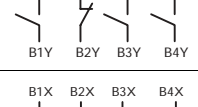
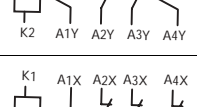
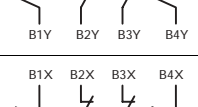

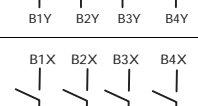
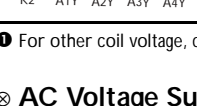
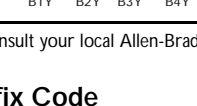
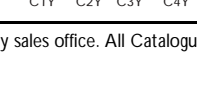
Connection Diagrams and Terminal Markings			Contacts		AC Coils	24V DC Coils
Coil and Main Contacts	Additional Contacts	Additional Contacts			Catalogue Number ❶	Catalogue Number ❶
			NO	NC		
	—	—	3	1	700S-P310⊗	700S-DCP310Z24
	—	—	2	2	700S-P220⊗	700S-DCP220Z24
		—	7	1	700S-P710⊗	700S-DCP710Z24
		—	6	2	700S-P620⊗	700S-DCP620Z24
		—	5	3	700S-P530⊗	700S-DCP530Z24
		—	4	4	700S-P440⊗	700S-DCP440Z24
		—	3	5	700S-P350⊗	700S-DCP350Z24
	 	—	10	2	700S-P1020⊗	700S-DCP1020Z24

❶ For other coil voltage, consult your local Allen-Bradley sales office. All Catalogue Numbers are factory-stocked.

#### ⊗ AC Voltage Suffix Code

The Catalogue Number as listed is incomplete. Select a voltage suffix code from the table below to complete the Catalogue Number. Example: Catalogue Number **700S-P310** becomes Catalogue Number **700S-P310A1** for a 120V AC coil.

Hz	24	115-120	230-240	277	460-480
60	A24	A1	A2	A27	A4

**Approximate Dimensions—mm (inches)**

Dimensions are not intended for manufacturing purposes.

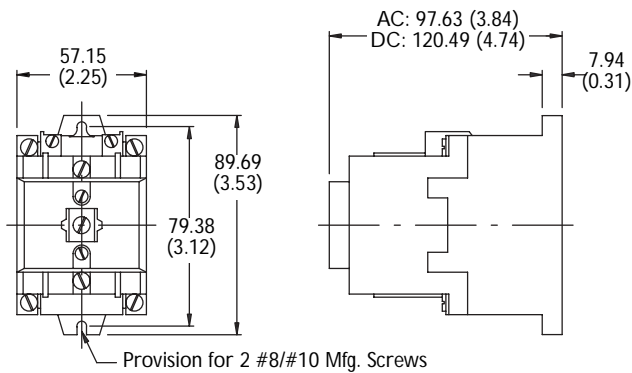

2- and 4-Pole Bulletin 700S-P Relay  
 Approximate Shipping Weight AC - 0.68kg (1.5lbs),  
 DC - 1.34kg (2.95lbs)

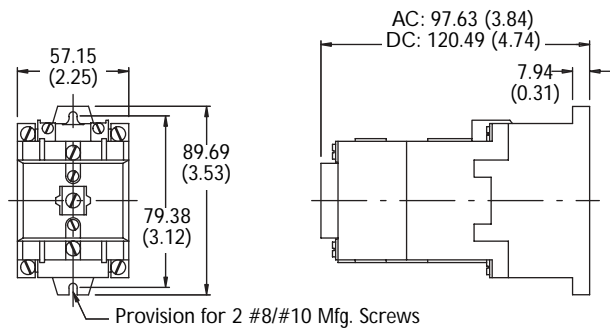

6- and 8-Pole Bulletin 700S-P Relay  
 Approximate Shipping Weight AC - 0.79kg (1.75lbs),  
 DC - 1.45kg (3.20lbs)

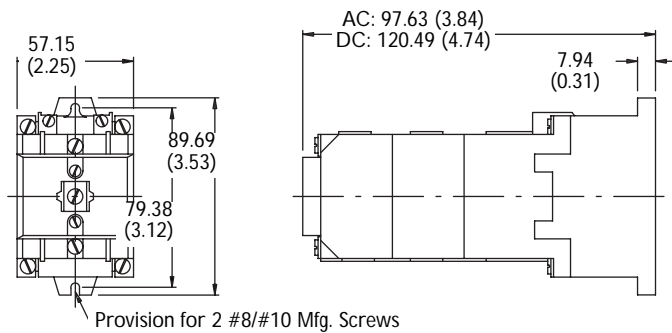

10- and 12-Pole Bulletin 700S-P Relay  
 Approximate Shipping Weight AC - 1.02kg (2.25lbs),  
 DC - 1.68kg (3.7lbs)

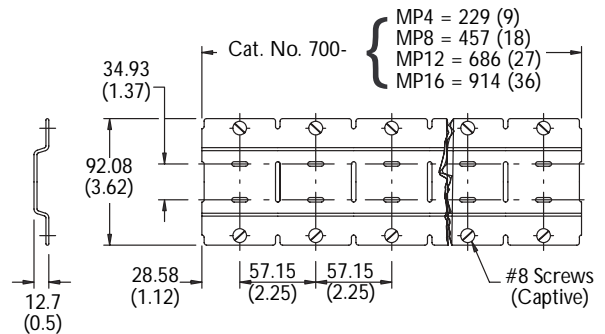

Universal Mounting Rail for Bulletin 700-P, -PH, -PK,  
 and 700S-P Relays