

# 712-475 Composite Conduit Bulkhead Feed-Through Adapter for Environmental or Non-Environmental Series 74 PEEK or Standard Tubing

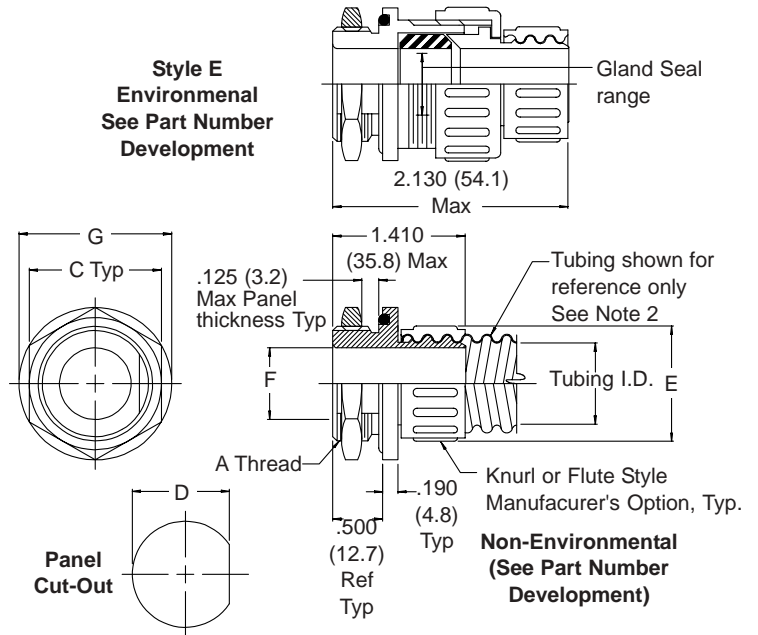
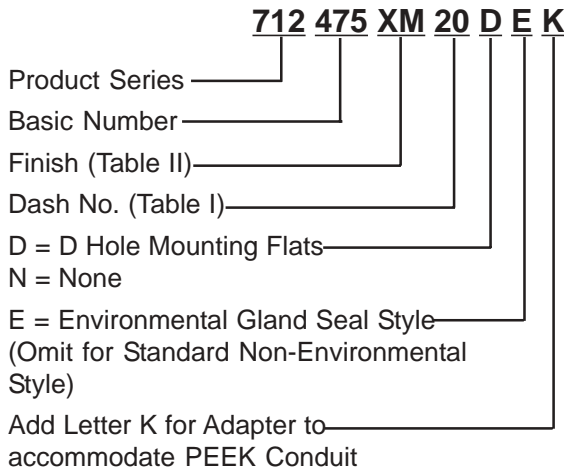

**Table I**

Dash No.	A Thread Class 2A	B +.015 (0.4) -.000 (0.0)	C Across Flats	D +.000 (0.0) -.015 (0.4)	E Max	F Min	G Max	Tubing I.D.		Gland Seal Range	
								Min	Max	Min	Max
06	M16 x 1.0	.640 (16.3)	.875 (22.2)	.595 (15.1)	.500 (12.7)	.162 (4.1)	1.020 (25.9)	.181 (4.6)	.187 (4.7)	.156 (4.0)	.250 (6.4)
09	M16 x 1.0	.640 (16.3)	.875 (22.2)	.595 (15.1)	.600 (15.2)	.244 (6.2)	1.020 (25.9)	.273 (6.9)	.281 (7.1)	.156 (4.0)	.250 (6.4)
10	M16 x 1.0	.640 (16.3)	.875 (22.2)	.595 (15.1)	.630 (16.0)	.274 (7.0)	1.020 (25.9)	.306 (7.8)	.312 (7.9)	.156 (4.0)	.250 (6.4)
12	M16 x 1.0	.640 (16.3)	.875 (22.2)	.595 (15.1)	.700 (17.8)	.326 (8.3)	1.020 (25.9)	.364 (9.2)	.375 (9.5)	.188 (4.8)	.312 (7.9)
14	M20 x 1.0	.802 (20.4)	1.062 (27.0)	1.752 (44.5)	.760 (19.3)	.382 (9.7)	1.180 (30.0)	.427 (10.8)	.437 (11.1)	.250 (6.4)	.438 (11.1)
16	M20 x 1.0	.802 (20.4)	1.062 (27.0)	1.752 (44.5)	.850 (21.6)	.434 (11.0)	1.180 (30.0)	.485 (12.3)	.500 (1.3)	.250 (6.4)	.438 (11.1)
20	M27 x 1.0	1.078 (27.4)	1.312 (33.3)	1.069 (27.2)	.970 (24.6)	.539 (13.7)	1.450 (36.8)	.608 (15.4)	.625 (15.9)	.375 (9.5)	.625 (15.9)
24	1-20 UNEF	1.005 (25.5)	1.312 (33.3)	.937 (23.8)	1.140 (29.0)	.649 (16.5)	1.390 (35.3)	.730 (18.5)	.750 (19.1)	.375 (9.5)	.625 (15.9)
28	M27 x 1.0	1.078 (27.4)	1.312 (33.3)	1.029 (26.1)	1.280 (32.5)	.769 (19.5)	1.450 (36.8)	.860 (21.8)	.875 (22.2)	.438 (11.1)	.750 (19.1)
32	M36 x 1.0	1.437 (36.5)	1.750 (44.5)	1.403 (35.6)	1.450 (36.8)	.868 (22.0)	1.810 (46.0)	.975 (24.8)	1.000 (25.4)	.625 (15.9)	.938 (23.8)
40	1 1/2 -18 UNEF	1.505 (38.2)	1.750 (44.5)	1.437 (36.5)	1.760 (44.7)	1.078 (27.4)	1.890 (48.0)	1.210 (30.7)	1.250 (31.8)	.875 (22.2)	1.250 (31.8)
48	1 3/4 -18 UNEF	1.755 (44.6)	2.000 (50.8)	1.687 (42.8)	2.060 (52.3)	1.200 (30.5)	2.140 (54.4)	1.437 (36.5)	1.500 (38.1)	1.000 (25.4)	1.375 (34.9)
56	2 -18 UNS	2.005 (50.9)	2.250 (57.2)	1.937 (49.2)	2.390 (60.7)	1.400 (35.6)	2.390 (60.7)	1.688 (42.9)	1.750 (44.5)	1.250 (31.8)	1.625 (41.3)
64	2 1/4 -16 UN	2.255 (57.3)	2.500 (63.5)	2.187 (55.5)	2.570 (65.3)	1.600 (40.6)	2.640 (67.1)	2.937 (74.6)	2.000 (50.8)	1.250 (31.8)	1.625 (41.3)

**Table II**

XM	Electroless Nickel
XW	Cadmium Olive Drab Over Electroless Nickel
XB	No Plating - Black Material
XO	No Plating - Base Material Non-conductive

**NOTES:**

1. Metric dimensions (mm) are in parentheses and are for reference only.
2. Convulved tubing size, tubing to be ordered separately (See Page I-23).