

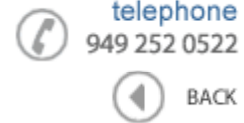

Data Sheet



Product Category: Filters

Series Number	Package	Description	Last Modified
746	SMD Ceramic Filter	455 KHz	Dec. 22 2008

Filter FEATURES

- Surface Mount
- RoHS Compliant



OPERATING CONDITIONS / ELECTRICAL CHARACTERISTICS / PART NUMBER GUIDE

PART NO.	6dB Bandwidth	40dB Bandwidth	Pass Band Ripple	Spurious Attenuation fn ±100KHz	Insertion Loss	In/Output Impedance
	KHz min.	KHz max.	dB max.	dB min.	dB max.	Kohm
746-455-BU	±15	±30	2	27	4	1
746-455-CU	±12.5	±25	2	27	4	1
746-455-DU	±10	±20	2	27	4	1.5
746-455-EU	±7.5	±15	2	27	6	1.5
746-455-FU	±6	±12	2	27	6	1.5
746-455-GU	±4.5	±10	2	25	6	1.5
746-455-HU	±3	±9	2	25	6	1.5
746-455-IU	±2	±7.5	2	25	6	1.5

NOTE: Deviations on all parameters available. Please consult Oscilent for details.

DEFINITIONS: Click on the characteristic names above, for definitions of the particular characteristic.

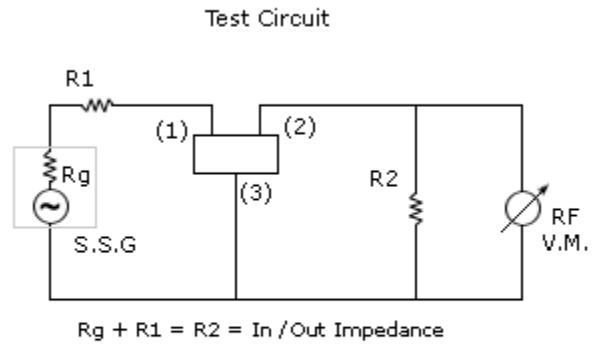
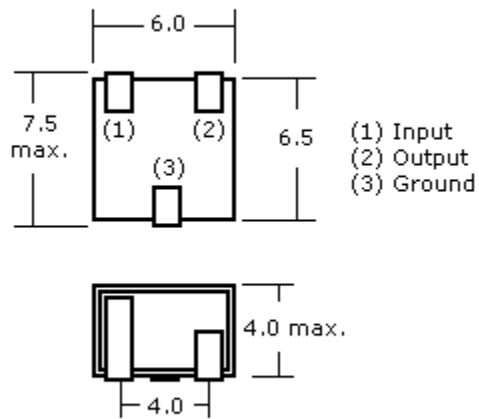
PACKAGE DIMENSIONS (mm)

Oscilent Corporation - CALL **949.252.0522**

18195 East McDermott Street . Building D . Irvine . CA 92614 . USA
 Fax: 949.252.0599 . E-Mail: Sales@Oscilent.com

Series No.: 746