

712-475 Composite Conduit Bulkhead Feed-Through Adapter for Environmental or Non-Environmental Series 74 PEEK or Standard Tubing

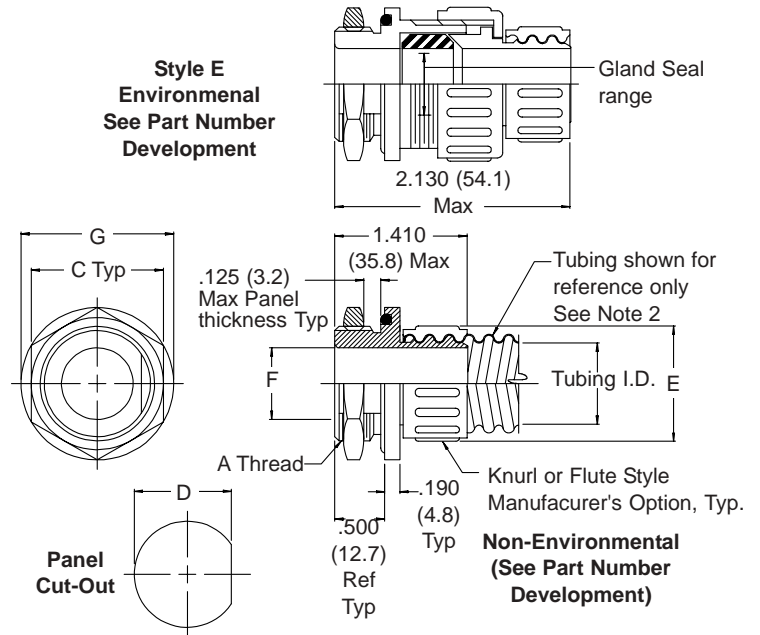
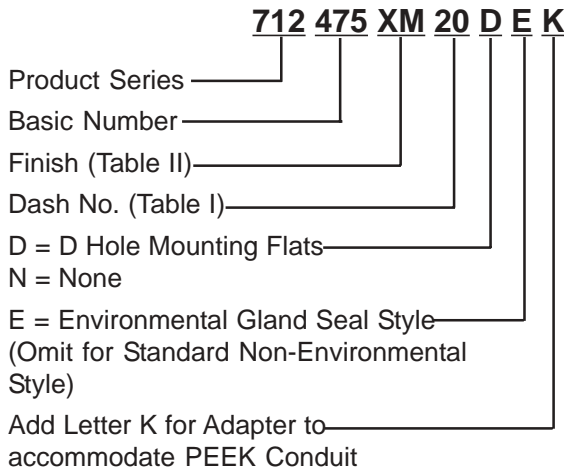

Table I

Dash No.	A Thread Class 2A	B +.015 (0.4) -.000 (0.0)	C Across Flats	D +.000 (0.0) -.015 (0.4)	E Max	F Min	G Max	Tubing I.D.		Gland Seal Range	
								Min	Max	Min	Max
06	M16 x 1.0	.640 (16.3)	.875 (22.2)	.595 (15.1)	.500 (12.7)	.162 (4.1)	1.020 (25.9)	.181 (4.6)	.187 (4.7)	.156 (4.0)	.250 (6.4)
09	M16 x 1.0	.640 (16.3)	.875 (22.2)	.595 (15.1)	.600 (15.2)	.244 (6.2)	1.020 (25.9)	.273 (6.9)	.281 (7.1)	.156 (4.0)	.250 (6.4)
10	M16 x 1.0	.640 (16.3)	.875 (22.2)	.595 (15.1)	.630 (16.0)	.274 (7.0)	1.020 (25.9)	.306 (7.8)	.312 (7.9)	.156 (4.0)	.250 (6.4)
12	M16 x 1.0	.640 (16.3)	.875 (22.2)	.595 (15.1)	.700 (17.8)	.326 (8.3)	1.020 (25.9)	.364 (9.2)	.375 (9.5)	.188 (4.8)	.312 (7.9)
14	M20 x 1.0	.802 (20.4)	1.062 (27.0)	1.752 (44.5)	.760 (19.3)	.382 (9.7)	1.180 (30.0)	.427 (10.8)	.437 (11.1)	.250 (6.4)	.438 (11.1)
16	M20 x 1.0	.802 (20.4)	1.062 (27.0)	1.752 (44.5)	.850 (21.6)	.434 (11.0)	1.180 (30.0)	.485 (12.3)	.500 (1.3)	.250 (6.4)	.438 (11.1)
20	M27 x 1.0	1.078 (27.4)	1.312 (33.3)	1.069 (27.2)	.970 (24.6)	.539 (13.7)	1.450 (36.8)	.608 (15.4)	.625 (15.9)	.375 (9.5)	.625 (15.9)
24	1-20 UNEF	1.005 (25.5)	1.312 (33.3)	.937 (23.8)	1.140 (29.0)	.649 (16.5)	1.390 (35.3)	.730 (18.5)	.750 (19.1)	.375 (9.5)	.625 (15.9)
28	M27 x 1.0	1.078 (27.4)	1.312 (33.3)	1.029 (26.1)	1.280 (32.5)	.769 (19.5)	1.450 (36.8)	.860 (21.8)	.875 (22.2)	.438 (11.1)	.750 (19.1)
32	M36 x 1.0	1.437 (36.5)	1.750 (44.5)	1.403 (35.6)	1.450 (36.8)	.868 (22.0)	1.810 (46.0)	.975 (24.8)	1.000 (25.4)	.625 (15.9)	.938 (23.8)
40	1 1/2 -18 UNEF	1.505 (38.2)	1.750 (44.5)	1.437 (36.5)	1.760 (44.7)	1.078 (27.4)	1.890 (48.0)	1.210 (30.7)	1.250 (31.8)	.875 (22.2)	1.250 (31.8)
48	1 3/4 -18 UNEF	1.755 (44.6)	2.000 (50.8)	1.687 (42.8)	2.060 (52.3)	1.200 (30.5)	2.140 (54.4)	1.437 (36.5)	1.500 (38.1)	1.000 (25.4)	1.375 (34.9)
56	2 -18 UNS	2.005 (50.9)	2.250 (57.2)	1.937 (49.2)	2.390 (60.7)	1.400 (35.6)	2.390 (60.7)	1.688 (42.9)	1.750 (44.5)	1.250 (31.8)	1.625 (41.3)
64	2 1/4 -16 UN	2.255 (57.3)	2.500 (63.5)	2.187 (55.5)	2.570 (65.3)	1.600 (40.6)	2.640 (67.1)	2.937 (74.6)	2.000 (50.8)	1.250 (31.8)	1.625 (41.3)

Table II

XM	Electroless Nickel
XW	Cadmium Olive Drab Over Electroless Nickel
XB	No Plating - Black Material
XO	No Plating - Base Material Non-conductive

NOTES:

1. Metric dimensions (mm) are in parentheses and are for reference only.
2. Convulved tubing size, tubing to be ordered separately (See Page I-23).