

### FEATURES

- Guaranteed  $V_{OS}$ : 500  $\mu\text{V}$  Max
- Guaranteed Matched CMRR: 94 dB Min
- Guaranteed Matched  $V_{OS}$ : 750  $\mu\text{V}$  Max
- LM148/LM348 Direct Replacement
- Low Noise
- Silicon-Nitride Passivation
- Internal Frequency Compensation
- Low Crossover Distortion
- Continuous Short-Circuit Protection
- Low Input Bias Current

### GENERAL DESCRIPTION

The OP11 provides four matched 741-type operational amplifiers in a single 14-lead DIP package. The OP11 is pin compatible with the LM148, LM348, RM4156, RM4158, and HA4741 amplifiers. The amplifier is matched for common-mode rejection ratio and offset voltage which is very important in designing instrumentation amplifiers. In addition, the amplifier is designed to have equal positive-going and negative-going slew rates. This is an important consideration for good audio system performance.

The OP11 is ideal for use in designs requiring minimum space and cost while maintaining performance.

### PIN CONFIGURATIONS

#### 14-Lead Epoxy DIP (P Suffix)

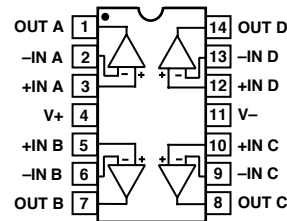

#### 14-Lead Hermetic DIP (Y Suffix)

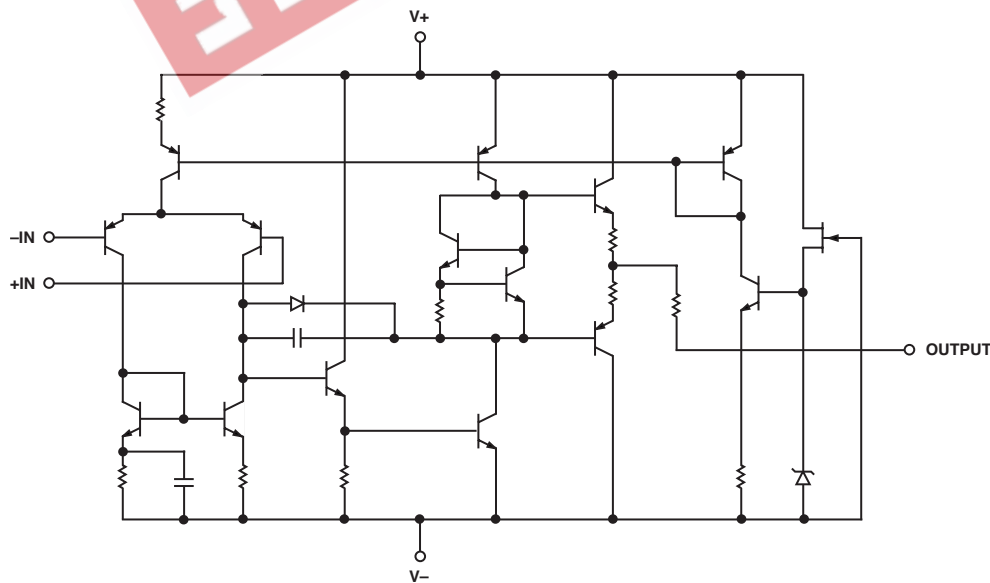
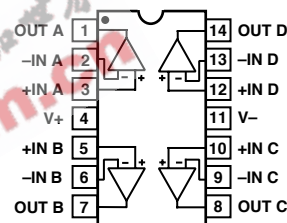

Figure 1. Simplified Schematic

### REV. A

Information furnished by Analog Devices is believed to be accurate and reliable. However, no responsibility is assumed by Analog Devices for its use, nor for any infringements of patents or other rights of third parties that may result from its use. No license is granted by implication or otherwise under any patent or patent rights of Analog Devices.

# OP11—SPECIFICATIONS

## ELECTRICAL CHARACTERISTICS (@ $V_S = \pm 15\text{ V}$ , $T_A = 25^\circ\text{C}$ , unless otherwise noted)

Parameter	Symbol	Conditions	OP11A/OP11E			OP11F			OP11G			Unit
			Min	Typ	Max	Min	Typ	Max	Min	Typ	Max	
Input Offset Voltage	$V_{OS}$	$R_S = 10\text{ k}\Omega$		0.3	0.5		0.6	2.5		1.2	5.0	mV
Input Offset Current	$I_{OS}$			5.5	20		25	50		75	200	nA
Input Bias Current	$I_B$			180	300		300	500		300	500	nA
Input Resistance Differential Mode <sup>1</sup>	$R_{IN}$		0.17	0.29		0.1	0.17		0.1	0.17		M $\Omega$
Input Voltage Range	IVR		$\pm 12$	$\pm 13$		$\pm 12$	$\pm 13$		$\pm 12$	$\pm 13$		V
Common-Mode Rejection Ratio	CMRR	$V_{CM} = \pm 12\text{ V}$ , $R_S = 10\text{ k}\Omega$	100	120		100	120		70	100		dB
Power Supply Rejection Ratio	PSRR	$V_S = \pm 5\text{ V}$ to $\pm 15\text{ V}$ , $R_S \leq 10\text{ k}\Omega$		4	32		4	32		10	100	$\mu\text{V/V}$
Output Voltage Swing	$V_O$	$R_L = 2\text{ k}\Omega$	$\pm 11$	$\pm 13$		$\pm 11$	$\pm 13$		$\pm 11$	$\pm 13$		V
Large-Signal Voltage Gain	$A_{VO}$	$R_L \leq 2\text{ k}\Omega$ , $V_O = \pm 10\text{ V}$	100	650		100	650		50	500		V/mV
Power Consumption <sup>2</sup>	$P_d$	$V_O = 0\text{ V}$		105	180		123	180		210	340	mW
Input Noise Voltage	$e_n$ p-p	0.1 Hz to 10 Hz		0.7			0.7			0.7		$\mu\text{V p-p}$
Input Noise Voltage Density	$e_n$	$f_o = 10\text{ Hz}$ $f_o = 100\text{ Hz}$ $f_o = 1\text{ MHz}$		18 14 12			18 14 12			18 14 12		$\text{nV}/\sqrt{\text{Hz}}$ $\text{nV}/\sqrt{\text{Hz}}$ $\text{nV}/\sqrt{\text{Hz}}$
Input Noise Current	$I_n$ p-p	0.1 Hz to 10 Hz		17			17			17		pA p-p
Input Noise Current Density	$I_n$	$f_o = 10\text{ Hz}$ $f_o = 100\text{ Hz}$ $f_o = 1\text{ MHz}$		1.8 1.5 1.2			1.8 1.5 1.2			1.8 1.5 1.2		$\text{pA}/\sqrt{\text{Hz}}$ $\text{pA}/\sqrt{\text{Hz}}$ $\text{pA}/\sqrt{\text{Hz}}$
Channel Separation	CS		100	130		100	130			130		dB
Slew Rate <sup>2</sup>	SR		0.7	1.0		0.7	1.0		0.7	1.0		V/ $\mu\text{s}$
Large Signal Bandwidth <sup>3</sup>		$V_O = 20\text{ V p-p}$	11	16		11	16		11	16		kHz
Closed-Loop Bandwidth <sup>4</sup>	BW	$A_{VCL} = 1$	2.4	3.0		2.4	3.0		2.4	3.0		MHz
Rise Time <sup>3</sup>	$t_r$	$A_V = 1$ , $V_{IN} = 50\text{ mV}$		110	145		110	145		110	145	ns
Overshoot <sup>3</sup>	OS			15	25		15	25		15	25	%

### NOTES

<sup>1</sup>Guaranteed by input bias current.

<sup>2</sup>Total dissipation for all four amplifiers in package.

<sup>3</sup>Sample tested.

<sup>4</sup>Guaranteed by rise time.

Specifications subject to change without notice

**ELECTRICAL CHARACTERISTICS** (@  $V_S = \pm 15\text{ V}$ ,  $-55^\circ\text{C} \leq T_A \leq +125^\circ\text{C}$  for OP11A,  $0^\circ\text{C} \leq T_A \leq 70^\circ\text{C}$  for OP11E, unless otherwise noted)

Parameter	Symbol	Conditions	OP11A			OP11E			Unit
			Min	Typ	Max	Min	Typ	Max	
Input Offset Voltage	$V_{OS}$	$R_S \leq 10\text{ k}\Omega$	0.4	1.0		0.4	0.8	mV	
Average Input Offset Voltage Drift <sup>1</sup>	$TCV_{OS}$	$R_S \leq 10\text{ k}\Omega$	2.0	10		2.0	10	$\mu\text{V}/^\circ\text{C}$	
Input Offset Current	$I_{OS}$		20	40		14	30	nA	
Average Input Offset Current Drift <sup>1</sup>	$TCI_{OS}$		0.1	0.3		0.1	0.3	$\text{nA}/^\circ\text{C}$	
Input Bias Current	$I_B$		200	375		200	350	nA	
Input Voltage Range	IVR		$\pm 12$	$\pm 13$		$\pm 12$	$\pm 13$	V	
Common-Mode Rejection Ratio	CMRR	$V_{CM} = \pm 12\text{ V}$ , $R_S \leq 10\text{ k}\Omega$	100	120		100	120	dB	
Power Supply Rejection Ratio	PSRR	$V_S = \pm 5\text{ V}$ to $\pm 15\text{ V}$ , $R_S \leq 10\text{ k}\Omega$		4	32		4	32	$\mu\text{V}/\text{V}$
Large-Signal Voltage Gain	$A_{VO}$	$R_L \geq 2\text{ k}\Omega$ , $V_O = \pm 10\text{ V}$	50	250		50	250	V/mV	
Output Voltage Swing	$V_O$	$R_L \geq 2\text{ k}\Omega$	$\pm 11$	$\pm 13$		$\pm 11$	$\pm 13$	V	
Power Consumption <sup>2</sup>	$P_d$	$V_O = 0\text{ V}$		115	200		115	200	mW

NOTES

<sup>1</sup>Guaranteed but not tested.

<sup>2</sup>Total dissipation for all four amplifiers in package.

Specifications subject to change without notice

**ELECTRICAL CHARACTERISTICS** (@  $V_S = \pm 15\text{ V}$ ,  $-40^\circ\text{C} \leq T_A \leq +85^\circ\text{C}$ ,  $R_S \leq 100\ \Omega$ , unless otherwise noted)

Parameter	Symbol	Conditions	OP11F			OP11G			Unit
			Min	Typ	Max	Min	Typ	Max	
Input Offset Voltage	$V_{OS}$	$R_S \leq 10\text{ k}\Omega$	0.8	3.0		1.5	6.0	mV	
Average Input Offset Voltage Drift	$TCV_{OS}$	$R_S \leq 10\text{ k}\Omega$	4.0	15		4.0		$\mu\text{V}/^\circ\text{C}$	
Input Offset Current	$I_{OS}$		40	60		250	300	nA	
Average Input Offset Current Drift <sup>1</sup>	$TCI_{OS}$		0.3	0.6		0.3	0.6	$\text{nA}/^\circ\text{C}$	
Input Bias Current	$I_B$		400	550		400	800	nA	
Input Voltage Range	IVR		$\pm 12$	$\pm 13$		$\pm 12$	$\pm 13$	V	
Common-Mode Rejection Ratio	CMRR	$V_{CM} = \pm 12\text{ V}$ , $R_S \leq 10\text{ k}\Omega$	100	120		70	100	dB	
Power Supply Rejection Ratio	PSRR	$V_S = \pm 5\text{ V}$ to $\pm 15\text{ V}$ , $R_S \leq 10\text{ k}\Omega$		4	32		10	100	$\mu\text{V}/\text{V}$
Large-Signal Voltage Gain	$A_{VO}$	$R_L \geq 2\text{ k}\Omega$ , $V_O = \pm 10\text{ V}$	50	250		25	100	V/mV	
Output Voltage Swing	$V_O$	$R_L \geq 2\text{ k}\Omega$	$\pm 11$	$\pm 13$		$\pm 11$	$\pm 13$	V	
Power Consumption <sup>2</sup>	$P_d$	$V_O = 0\text{ V}$		115	200		250	400	mW

NOTES

<sup>1</sup>Guaranteed but not tested.

<sup>2</sup>Total dissipation for all four amplifiers in package.

Specifications subject to change without notice

# OP11

## ABSOLUTE MAXIMUM RATINGS\*

Supply Voltage ( $V_S$ )	$\pm 22$ V
Input Voltage*	Supply Voltage
Differential Input Voltage	$\pm 30$ V
Output Short-Circuit Duration	Continuous (One Amp Only)

## Storage Temperature Range

Y Package	$-65^\circ\text{C}$ to $+150^\circ\text{C}$
P Package	$-65^\circ\text{C}$ to $+125^\circ\text{C}$
Lead Temperature Range (Soldering, 60 sec)	$300^\circ\text{C}$
Operating Temperature Range	
OP11A	$-55^\circ\text{C}$ to $+125^\circ\text{C}$
OP11E	$0^\circ\text{C}$ to $70^\circ\text{C}$
OP11F, OP11G	$-40^\circ\text{C}$ to $+85^\circ\text{C}$

\*Absolute maximum ratings apply to both DICE and packaged parts, unless otherwise noted.

Package Type	$\theta_{JA}$ *	$\theta_{JC}$	Unit
14-Lead Plastic DIP (P)	83	39	$^\circ\text{C}/\text{W}$
14-Lead Hermetic DIP (Y)	108	15	$^\circ\text{C}/\text{W}$

\* $\theta_{JA}$  is specified for worst-case conditions, i.e.,  $\theta_{JA}$  is specified for device in socket for CERDIP and P-DIP packages.

## ORDERING GUIDE

Model	Temperature Range	Package Description	Package Option
OP11AY*	$-40^\circ\text{C}$ to $+125^\circ\text{C}$	14-Lead CERDIP	Y-14
OP11EP	$-40^\circ\text{C}$ to $+125^\circ\text{C}$	14-Lead Epoxy DIP	P-14
OP11EY*	$0^\circ\text{C}$ to $85^\circ\text{C}$	14-Lead CERDIP	Y-14
OP11FP*	$-40^\circ\text{C}$ to $85^\circ\text{C}$	14-Lead Epoxy DIP	P-14
OP11GP	$-40^\circ\text{C}$ to $85^\circ\text{C}$	14-Lead Epoxy DIP	P-14

\*Not for new designs. Obsolete April 2002.

For Military processed devices, please refer to the Standard Microcircuit Drawing (SMD) available at [www.dsccl.dla.mil/programs/milspec/default.asp](http://www.dsccl.dla.mil/programs/milspec/default.asp)

SMD Part Number	ADI Equivalent
5962-89801012A	OP11ARCMDA
5962-8980101CA	OP11AYMDA

## MATCHING CHARACTERISTICS (@ $V_S = \pm 15$ V, $T_A = 25^\circ\text{C}$ , $R_S \leq 100 \Omega$ , unless otherwise noted)

Parameter	Symbol	Conditions	OP11A, OP11E			OP11F			Unit	
			Min	Typ	Max	Min	Typ	Max		
Input Offset Voltage Match	$\Delta V_{OS}$			0.5	0.75		0.6	2.0	mV	
Common-Mode Rejection Ratio Match	$\Delta \text{CMRR}$	$V_{CM} = \pm 12$ V $V_{CM} = \pm 12$ V	94	1	20	120	94	1	20	$\mu\text{V}/\text{V}$ dB

Specifications subject to change without notice

## MATCHING CHARACTERISTICS (@ $V_S = \pm 15$ V, $-55^\circ\text{C} \leq T_A \leq +125^\circ\text{C}$ for OP11A, $0^\circ\text{C} \leq T_A \leq 70^\circ\text{C}$ for OP11E, $-40^\circ\text{C} \leq T_A \leq +85^\circ\text{C}$ for OP11F, $R_S \leq 100 \Omega$ , unless otherwise noted)

Parameter	Symbol	Conditions	OP11A, OP11E			OP11F			Unit	
			Min	Typ	Max	Min	Typ	Max		
Input Offset Voltage Match	$\Delta V_{OS}$			0.6	1.0		1.0	2.5	mV	
Common-Mode Rejection Ratio Match	$\Delta \text{CMRR}$	$V_{CM} = \pm 12$ V $V_{CM} = \pm 12$ V	94	3.2	20	110	94	3.2	20	$\mu\text{V}/\text{V}$ dB

Specifications subject to change without notice

## CAUTION

ESD (electrostatic discharge) sensitive device. Electrostatic charges as high as 4000 V readily accumulate on the human body and test equipment and can discharge without detection. Although the OP11 features proprietary ESD protection circuitry, permanent damage may occur on devices subjected to high-energy electrostatic discharges. Therefore, proper ESD precautions are recommended to avoid performance degradation or loss of functionality.



# Typical Performance Characteristics—OP11

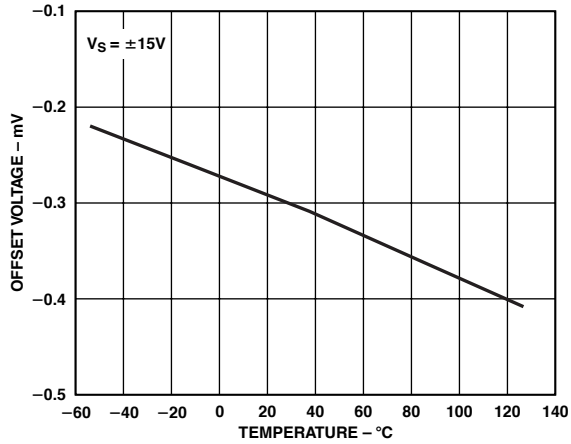

TPC 1. Input Offset Voltage vs. Temperature

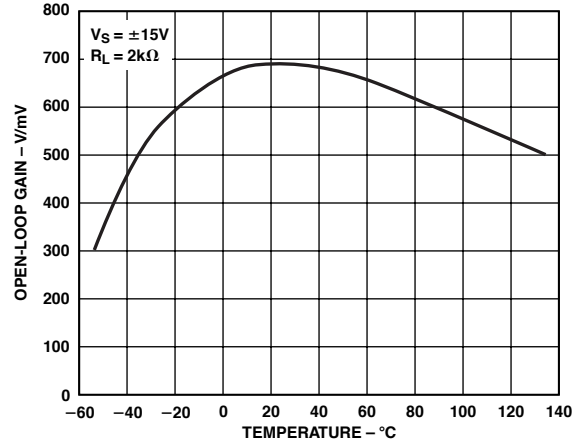

TPC 4. Open-Loop Gain vs. Temperature

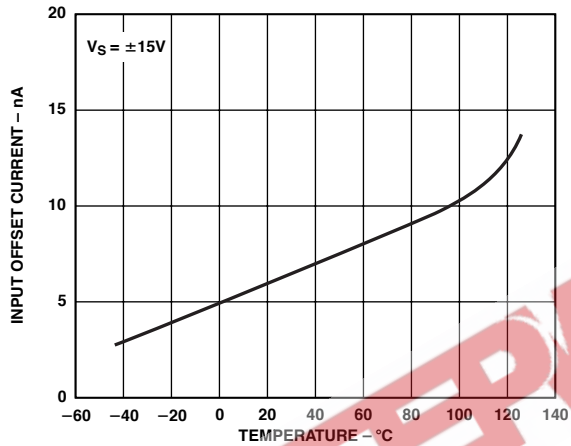

TPC 2. Offset Current vs. Temperature

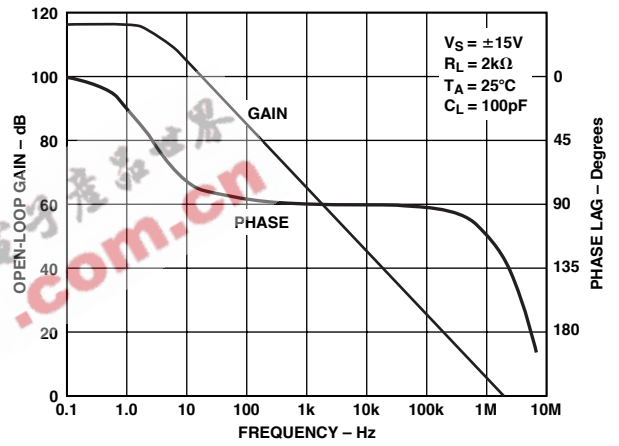

TPC 5. Open-Loop Gain and Phase vs. Frequency

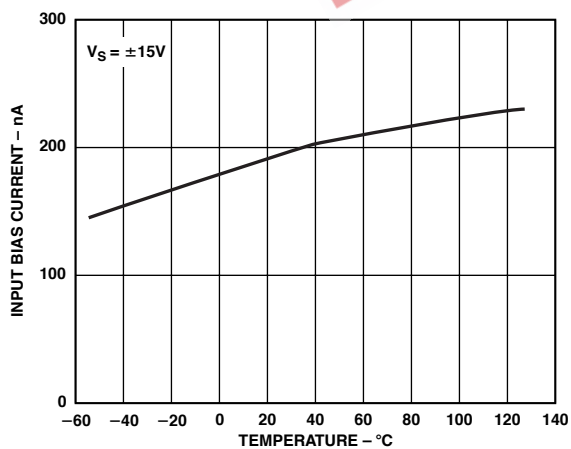

TPC 3. Bias Current vs. Temperature

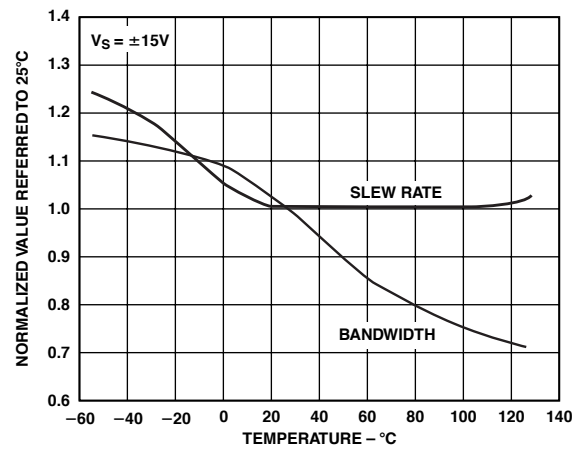

TPC 6. Normalized Slew Rate and Bandwidth vs. Temperature

# OP11

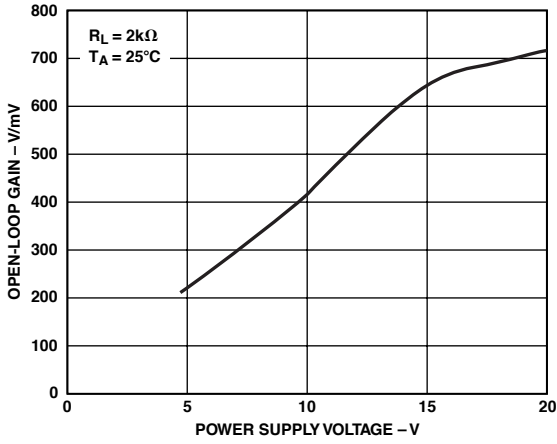

TPC 7. Open-Loop Gain vs. Supply Voltage

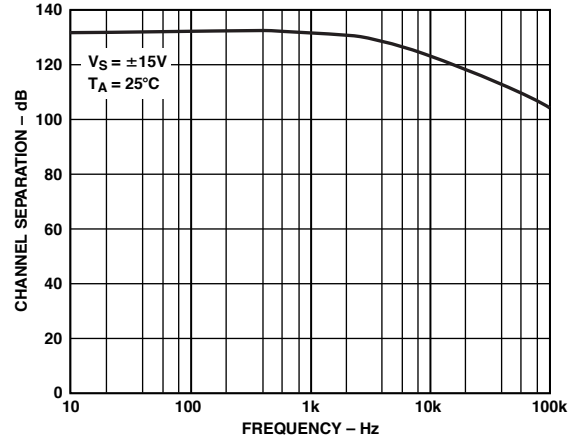

TPC 10. Channel Separation vs. Frequency

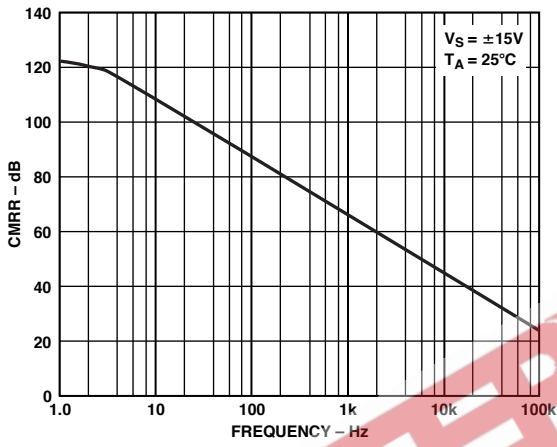

TPC 8. CMRR vs. Frequency

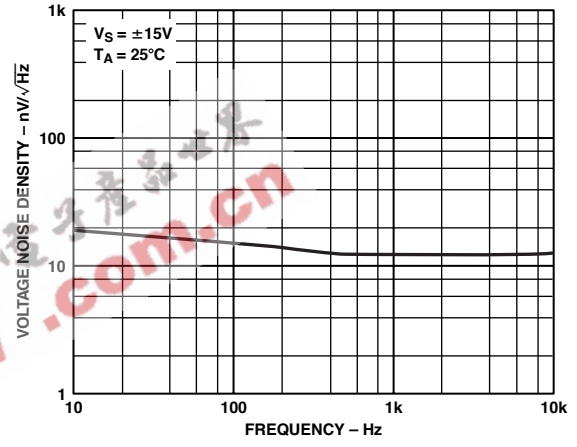

TPC 11. Voltage Noise Density vs. Frequency

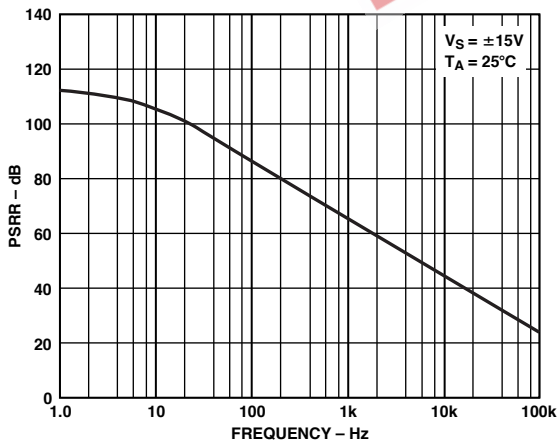

TPC 9. PSRR vs. Frequency

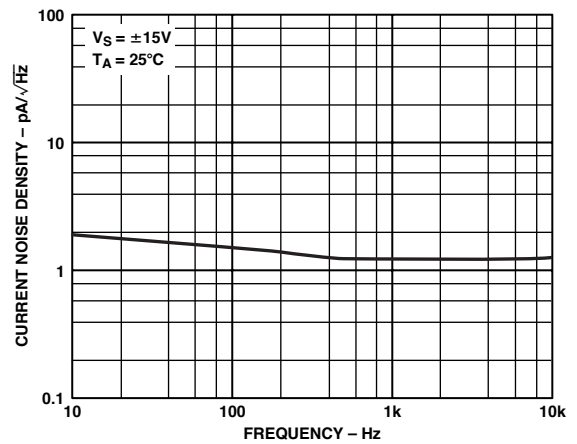

TPC 12. Noise Current Density vs. Frequency

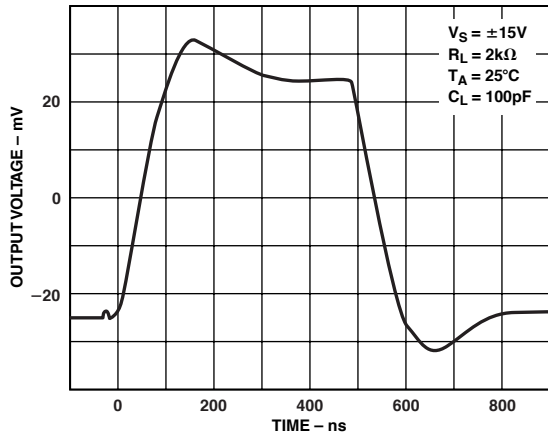

TPC 13. Transient Response

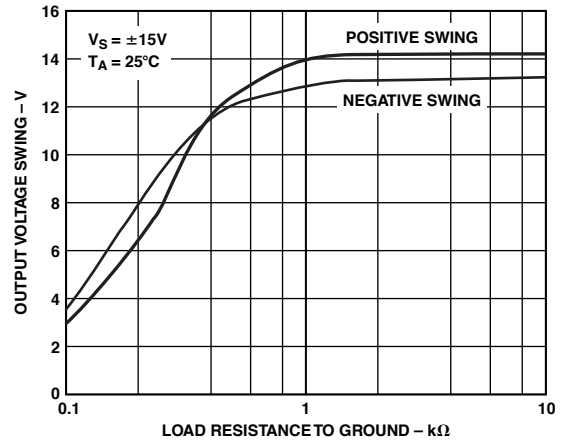

TPC 16. Output Voltage vs. Load Resistance

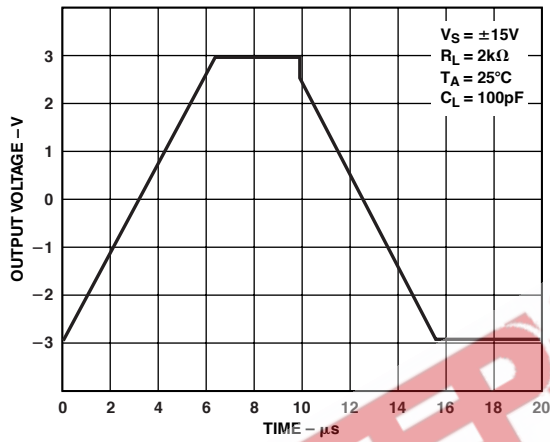

TPC 14. Voltage Follower Pulse Response

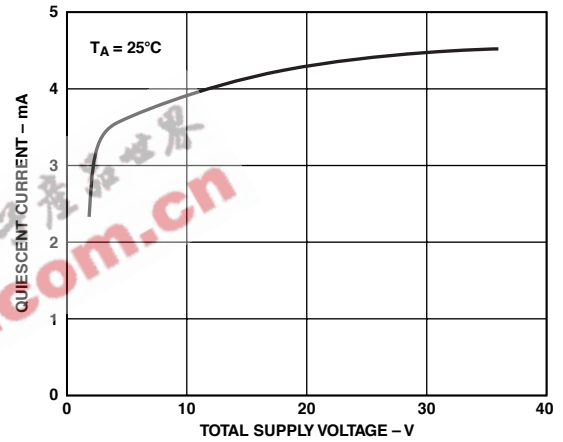

TPC 17. Quiescent Current vs. Supply Voltage

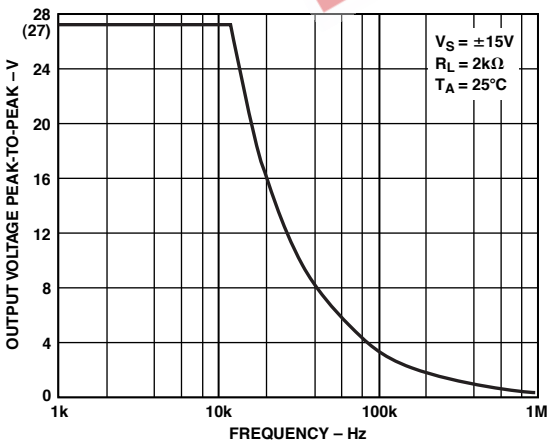

TPC 15. Maximum Output Swing vs. Frequency

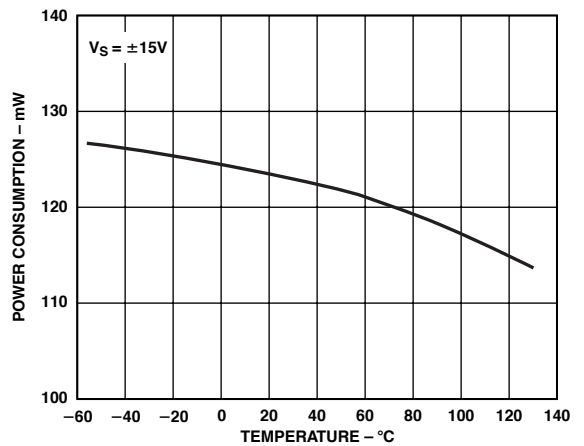

TPC 18. Power Consumption vs. Temperature

## OUTLINE DIMENSIONS

Dimensions shown in inches and (mm).

### 14-Lead Epoxy DIP (P Suffix)

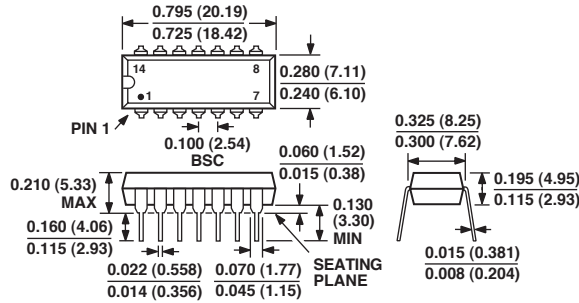

### 14-Lead Hermetic DIP (Y Suffix)

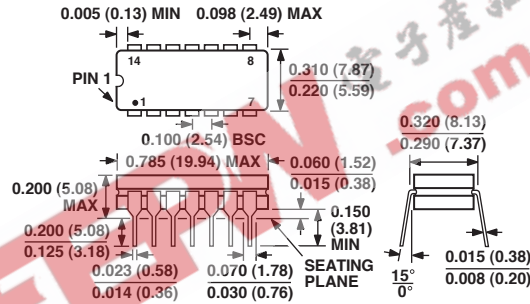

## Revision History

Location	Page
<b>Data Sheet changed from REV. 0 to REV. A.</b>	
Change OP-09/OP-11 to OP11 .....	Global
Edits to PIN CONNECTIONS .....	1
Edits to Figure 1 .....	1
Edits to ABSOLUTE MAXIMUM RATINGS .....	2
Edits to ORDERING GUIDE .....	2
Edits to SPEC TABLES .....	2-4
Deletion of DICE CHARACTERISTICS .....	5
Deletion of WAFER TEST LIMITS Table .....	5
Deletion of TYPICAL ELECTRICAL CHARACTERISTICS Table .....	5