

FEATURES

- Guaranteed V_{OS} : 500 μV Max
- Guaranteed Matched CMRR: 94 dB Min
- Guaranteed Matched V_{OS} : 750 μV Max
- LM148/LM348 Direct Replacement
- Low Noise
- Silicon-Nitride Passivation
- Internal Frequency Compensation
- Low Crossover Distortion
- Continuous Short-Circuit Protection
- Low Input Bias Current

GENERAL DESCRIPTION

The OP11 provides four matched 741-type operational amplifiers in a single 14-lead DIP package. The OP11 is pin compatible with the LM148, LM348, RM4156, RM4158, and HA4741 amplifiers. The amplifier is matched for common-mode rejection ratio and offset voltage which is very important in designing instrumentation amplifiers. In addition, the amplifier is designed to have equal positive-going and negative-going slew rates. This is an important consideration for good audio system performance.

The OP11 is ideal for use in designs requiring minimum space and cost while maintaining performance.

PIN CONFIGURATIONS

14-Lead Epoxy DIP (P Suffix)

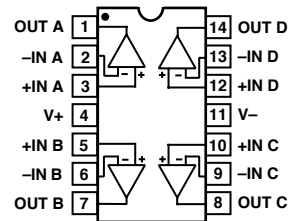

14-Lead Hermetic DIP (Y Suffix)

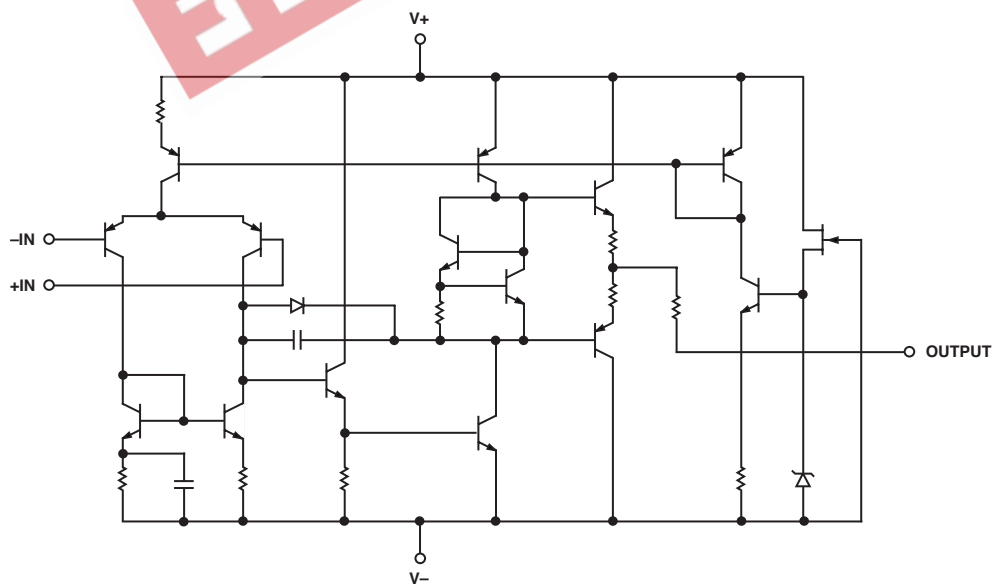
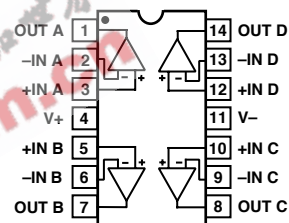

Figure 1. Simplified Schematic

REV. A

Information furnished by Analog Devices is believed to be accurate and reliable. However, no responsibility is assumed by Analog Devices for its use, nor for any infringements of patents or other rights of third parties that may result from its use. No license is granted by implication or otherwise under any patent or patent rights of Analog Devices.

OP11—SPECIFICATIONS

ELECTRICAL CHARACTERISTICS (@ $V_S = \pm 15\text{ V}$, $T_A = 25^\circ\text{C}$, unless otherwise noted)

| Parameter | Symbol | Conditions | OP11A/OP11E | | | OP11F | | | OP11G | | | Unit |
|--|-----------|---|-------------|-------------------|-----|----------|-------------------|-----|----------|-------------------|-----|--|
| | | | Min | Typ | Max | Min | Typ | Max | Min | Typ | Max | |
| Input Offset Voltage | V_{OS} | $R_S = 10\text{ k}\Omega$ | | 0.3 | 0.5 | | 0.6 | 2.5 | | 1.2 | 5.0 | mV |
| Input Offset Current | I_{OS} | | | 5.5 | 20 | | 25 | 50 | | 75 | 200 | nA |
| Input Bias Current | I_B | | | 180 | 300 | | 300 | 500 | | 300 | 500 | nA |
| Input Resistance Differential Mode ¹ | R_{IN} | | 0.17 | 0.29 | | 0.1 | 0.17 | | 0.1 | 0.17 | | $M\Omega$ |
| Input Voltage Range | IVR | | ± 12 | ± 13 | | ± 12 | ± 13 | | ± 12 | ± 13 | | V |
| Common-Mode Rejection Ratio | CMRR | $V_{CM} = \pm 12\text{ V}$, $R_S = 10\text{ k}\Omega$ | 100 | 120 | | 100 | 120 | | 70 | 100 | | dB |
| Power Supply Rejection Ratio | PSRR | $V_S = \pm 5\text{ V}$ to $\pm 15\text{ V}$, $R_S \leq 10\text{ k}\Omega$ | | 4 | 32 | | 4 | 32 | | 10 | 100 | $\mu\text{V/V}$ |
| Output Voltage Swing | V_O | $R_L = 2\text{ k}\Omega$ | ± 11 | ± 13 | | ± 11 | ± 13 | | ± 11 | ± 13 | | V |
| Large-Signal Voltage Gain | A_{VO} | $R_L \leq 2\text{ k}\Omega$, $V_O = \pm 10\text{ V}$ | 100 | 650 | | 100 | 650 | | 50 | 500 | | V/mV |
| Power Consumption ² | P_d | $V_O = 0\text{ V}$ | | 105 | 180 | | 123 | 180 | | 210 | 340 | mW |
| Input Noise Voltage | e_n p-p | 0.1 Hz to 10 Hz | | 0.7 | | | 0.7 | | | 0.7 | | $\mu\text{V p-p}$ |
| Input Noise Voltage Density | e_n | $f_o = 10\text{ Hz}$ $f_o = 100\text{ Hz}$ $f_o = 1\text{ MHz}$ | | 18 14 12 | | | 18 14 12 | | | 18 14 12 | | $\text{nV}/\sqrt{\text{Hz}}$ $\text{nV}/\sqrt{\text{Hz}}$ $\text{nV}/\sqrt{\text{Hz}}$ |
| Input Noise Current | I_n p-p | 0.1 Hz to 10 Hz | | 17 | | | 17 | | | 17 | | pA p-p |
| Input Noise Current Density | I_n | $f_o = 10\text{ Hz}$ $f_o = 100\text{ Hz}$ $f_o = 1\text{ MHz}$ | | 1.8 1.5 1.2 | | | 1.8 1.5 1.2 | | | 1.8 1.5 1.2 | | $\text{pA}/\sqrt{\text{Hz}}$ $\text{pA}/\sqrt{\text{Hz}}$ $\text{pA}/\sqrt{\text{Hz}}$ |
| Channel Separation | CS | | 100 | 130 | | 100 | 130 | | | 130 | | dB |
| Slew Rate ² | SR | | 0.7 | 1.0 | | 0.7 | 1.0 | | 0.7 | 1.0 | | $\text{V}/\mu\text{s}$ |
| Large Signal Bandwidth ³ | | $V_O = 20\text{ V p-p}$ | 11 | 16 | | 11 | 16 | | 11 | 16 | | kHz |
| Closed-Loop Bandwidth ⁴ | BW | $A_{VCL} = 1$ | 2.4 | 3.0 | | 2.4 | 3.0 | | 2.4 | 3.0 | | MHz |
| Rise Time ³ | t_r | $A_V = 1$, $V_{IN} = 50\text{ mV}$ | | 110 | 145 | | 110 | 145 | | 110 | 145 | ns |
| Overshoot ³ | OS | | | 15 | 25 | | 15 | 25 | | 15 | 25 | % |

NOTES

¹Guaranteed by input bias current.

²Total dissipation for all four amplifiers in package.

³Sample tested.

⁴Guaranteed by rise time.

Specifications subject to change without notice

ELECTRICAL CHARACTERISTICS (@ $V_S = \pm 15\text{ V}$, $-55^\circ\text{C} \leq T_A \leq +125^\circ\text{C}$ for OP11A, $0^\circ\text{C} \leq T_A \leq 70^\circ\text{C}$ for OP11E, unless otherwise noted)

| Parameter | Symbol | Conditions | OP11A | | | OP11E | | | Unit |
|---|------------|---|----------|----------|-----|----------|----------|------------------------------|------------------------|
| | | | Min | Typ | Max | Min | Typ | Max | |
| Input Offset Voltage | V_{OS} | $R_S \leq 10\text{ k}\Omega$ | 0.4 | 1.0 | | 0.4 | 0.8 | mV | |
| Average Input Offset Voltage Drift ¹ | TCV_{OS} | $R_S \leq 10\text{ k}\Omega$ | 2.0 | 10 | | 2.0 | 10 | $\mu\text{V}/^\circ\text{C}$ | |
| Input Offset Current | I_{OS} | | 20 | 40 | | 14 | 30 | nA | |
| Average Input Offset Current Drift ¹ | TCI_{OS} | | 0.1 | 0.3 | | 0.1 | 0.3 | $\text{nA}/^\circ\text{C}$ | |
| Input Bias Current | I_B | | 200 | 375 | | 200 | 350 | nA | |
| Input Voltage Range | IVR | | ± 12 | ± 13 | | ± 12 | ± 13 | V | |
| Common-Mode Rejection Ratio | CMRR | $V_{CM} = \pm 12\text{ V}$, $R_S \leq 10\text{ k}\Omega$ | 100 | 120 | | 100 | 120 | dB | |
| Power Supply Rejection Ratio | PSRR | $V_S = \pm 5\text{ V}$ to $\pm 15\text{ V}$, $R_S \leq 10\text{ k}\Omega$ | | 4 | 32 | | 4 | 32 | $\mu\text{V}/\text{V}$ |
| Large-Signal Voltage Gain | A_{VO} | $R_L \geq 2\text{ k}\Omega$, $V_O = \pm 10\text{ V}$ | 50 | 250 | | 50 | 250 | V/mV | |
| Output Voltage Swing | V_O | $R_L \geq 2\text{ k}\Omega$ | ± 11 | ± 13 | | ± 11 | ± 13 | V | |
| Power Consumption ² | P_d | $V_O = 0\text{ V}$ | | 115 | 200 | | 115 | 200 | mW |

NOTES

¹Guaranteed but not tested.

²Total dissipation for all four amplifiers in package.

Specifications subject to change without notice

ELECTRICAL CHARACTERISTICS (@ $V_S = \pm 15\text{ V}$, $-40^\circ\text{C} \leq T_A \leq +85^\circ\text{C}$, $R_S \leq 100\ \Omega$, unless otherwise noted)

| Parameter | Symbol | Conditions | OP11F | | | OP11G | | | Unit |
|---|------------|---|----------|----------|-----|----------|----------|------------------------------|------------------------|
| | | | Min | Typ | Max | Min | Typ | Max | |
| Input Offset Voltage | V_{OS} | $R_S \leq 10\text{ k}\Omega$ | 0.8 | 3.0 | | 1.5 | 6.0 | mV | |
| Average Input Offset Voltage Drift | TCV_{OS} | $R_S \leq 10\text{ k}\Omega$ | 4.0 | 15 | | 4.0 | | $\mu\text{V}/^\circ\text{C}$ | |
| Input Offset Current | I_{OS} | | 40 | 60 | | 250 | 300 | nA | |
| Average Input Offset Current Drift ¹ | TCI_{OS} | | 0.3 | 0.6 | | 0.3 | 0.6 | $\text{nA}/^\circ\text{C}$ | |
| Input Bias Current | I_B | | 400 | 550 | | 400 | 800 | nA | |
| Input Voltage Range | IVR | | ± 12 | ± 13 | | ± 12 | ± 13 | V | |
| Common-Mode Rejection Ratio | CMRR | $V_{CM} = \pm 12\text{ V}$, $R_S \leq 10\text{ k}\Omega$ | 100 | 120 | | 70 | 100 | dB | |
| Power Supply Rejection Ratio | PSRR | $V_S = \pm 5\text{ V}$ to $\pm 15\text{ V}$, $R_S \leq 10\text{ k}\Omega$ | | 4 | 32 | | 10 | 100 | $\mu\text{V}/\text{V}$ |
| Large-Signal Voltage Gain | A_{VO} | $R_L \geq 2\text{ k}\Omega$, $V_O = \pm 10\text{ V}$ | 50 | 250 | | 25 | 100 | V/mV | |
| Output Voltage Swing | V_O | $R_L \geq 2\text{ k}\Omega$ | ± 11 | ± 13 | | ± 11 | ± 13 | V | |
| Power Consumption ² | P_d | $V_O = 0\text{ V}$ | | 115 | 200 | | 250 | 400 | mW |

NOTES

¹Guaranteed but not tested.

²Total dissipation for all four amplifiers in package.

Specifications subject to change without notice

OP11

ABSOLUTE MAXIMUM RATINGS*

| | |
|-------------------------------|------------------------------|
| Supply Voltage (V_S) | ± 22 V |
| Input Voltage* | Supply Voltage |
| Differential Input Voltage | ± 30 V |
| Output Short-Circuit Duration | Continuous (One Amp Only) |

Storage Temperature Range

| | |
|--|---|
| Y Package | -65°C to $+150^\circ\text{C}$ |
| P Package | -65°C to $+125^\circ\text{C}$ |
| Lead Temperature Range (Soldering, 60 sec) | 300°C |
| Operating Temperature Range | |
| OP11A | -55°C to $+125^\circ\text{C}$ |
| OP11E | 0°C to 70°C |
| OP11F, OP11G | -40°C to $+85^\circ\text{C}$ |

*Absolute maximum ratings apply to both DICE and packaged parts, unless otherwise noted.

| Package Type | θ_{JA} * | θ_{JC} | Unit |
|--------------------------|-----------------|---------------|---------------------------|
| 14-Lead Plastic DIP (P) | 83 | 39 | $^\circ\text{C}/\text{W}$ |
| 14-Lead Hermetic DIP (Y) | 108 | 15 | $^\circ\text{C}/\text{W}$ |

* θ_{JA} is specified for worst-case conditions, i.e., θ_{JA} is specified for device in socket for CERDIP and P-DIP packages.

ORDERING GUIDE

| Model | Temperature Range | Package Description | Package Option |
|---------|---|---------------------|----------------|
| OP11AY* | -40°C to $+125^\circ\text{C}$ | 14-Lead CERDIP | Y-14 |
| OP11EP | -40°C to $+125^\circ\text{C}$ | 14-Lead Epoxy DIP | P-14 |
| OP11EY* | 0°C to 85°C | 14-Lead CERDIP | Y-14 |
| OP11FP* | -40°C to 85°C | 14-Lead Epoxy DIP | P-14 |
| OP11GP | -40°C to 85°C | 14-Lead Epoxy DIP | P-14 |

*Not for new designs. Obsolete April 2002.

For Military processed devices, please refer to the Standard Microcircuit Drawing (SMD) available at www.dsccl.dla.mil/programs/milspec/default.asp

| SMD Part Number | ADI Equivalent |
|-----------------|----------------|
| 5962-89801012A | OP11ARCMDA |
| 5962-8980101CA | OP11AYMDA |

MATCHING CHARACTERISTICS (@ $V_S = \pm 15$ V, $T_A = 25^\circ\text{C}$, $R_S \leq 100 \Omega$, unless otherwise noted)

| Parameter | Symbol | Conditions | OP11A, OP11E | | | OP11F | | | Unit | |
|-----------------------------------|----------------------|--|--------------|-----|------|-------|-----|-----|------|------------------------------|
| | | | Min | Typ | Max | Min | Typ | Max | | |
| Input Offset Voltage Match | ΔV_{OS} | | | 0.5 | 0.75 | | 0.6 | 2.0 | mV | |
| Common-Mode Rejection Ratio Match | ΔCMRR | $V_{CM} = \pm 12$ V $V_{CM} = \pm 12$ V | 94 | 1 | 20 | 120 | 94 | 1 | 20 | $\mu\text{V}/\text{V}$ dB |

Specifications subject to change without notice

MATCHING CHARACTERISTICS (@ $V_S = \pm 15$ V, $-55^\circ\text{C} \leq T_A \leq +125^\circ\text{C}$ for OP11A, $0^\circ\text{C} \leq T_A \leq 70^\circ\text{C}$ for OP11E, $-40^\circ\text{C} \leq T_A \leq +85^\circ\text{C}$ for OP11F, $R_S \leq 100 \Omega$, unless otherwise noted)

| Parameter | Symbol | Conditions | OP11A, OP11E | | | OP11F | | | Unit | |
|-----------------------------------|----------------------|--|--------------|-----|-----|-------|-----|-----|------|------------------------------|
| | | | Min | Typ | Max | Min | Typ | Max | | |
| Input Offset Voltage Match | ΔV_{OS} | | | 0.6 | 1.0 | | 1.0 | 2.5 | mV | |
| Common-Mode Rejection Ratio Match | ΔCMRR | $V_{CM} = \pm 12$ V $V_{CM} = \pm 12$ V | 94 | 3.2 | 20 | 110 | 94 | 3.2 | 20 | $\mu\text{V}/\text{V}$ dB |

Specifications subject to change without notice

CAUTION

ESD (electrostatic discharge) sensitive device. Electrostatic charges as high as 4000 V readily accumulate on the human body and test equipment and can discharge without detection. Although the OP11 features proprietary ESD protection circuitry, permanent damage may occur on devices subjected to high-energy electrostatic discharges. Therefore, proper ESD precautions are recommended to avoid performance degradation or loss of functionality.



Typical Performance Characteristics—OP11

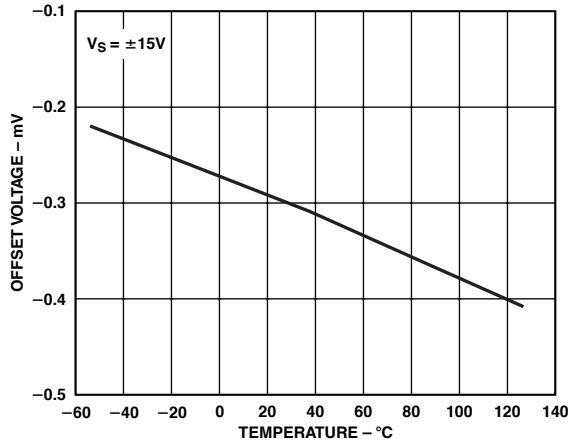

TPC 1. Input Offset Voltage vs. Temperature

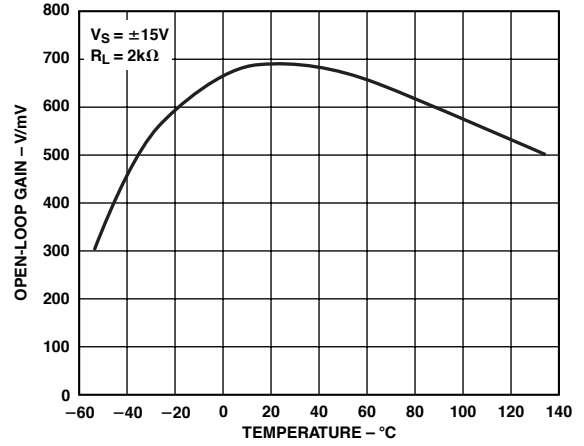

TPC 4. Open-Loop Gain vs. Temperature

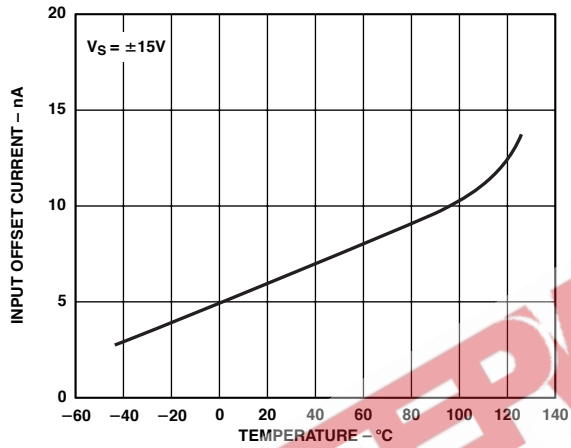

TPC 2. Offset Current vs. Temperature

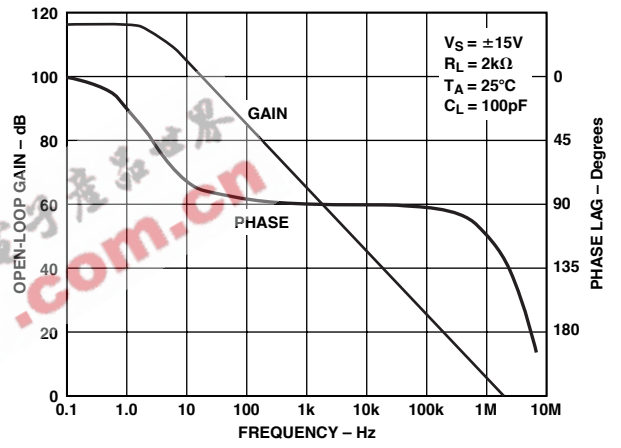

TPC 5. Open-Loop Gain and Phase vs. Frequency

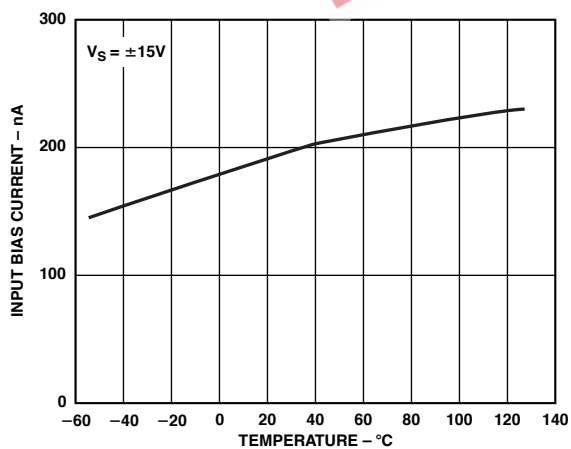

TPC 3. Bias Current vs. Temperature

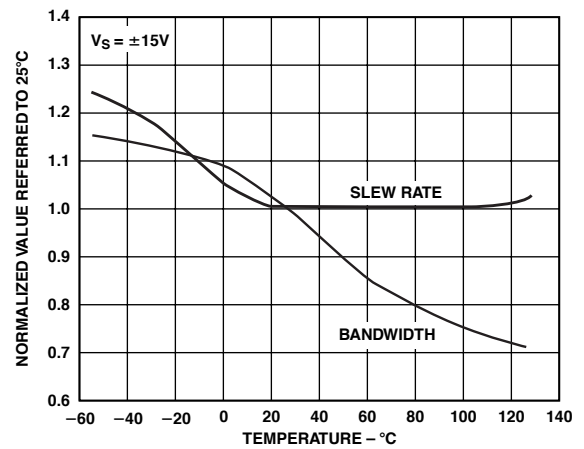

TPC 6. Normalized Slew Rate and Bandwidth vs. Temperature

OP11

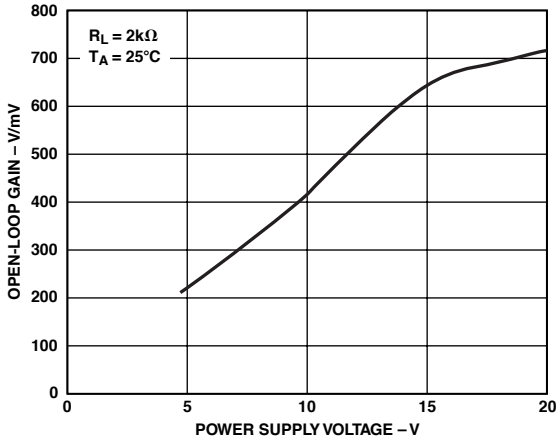

TPC 7. Open-Loop Gain vs. Supply Voltage

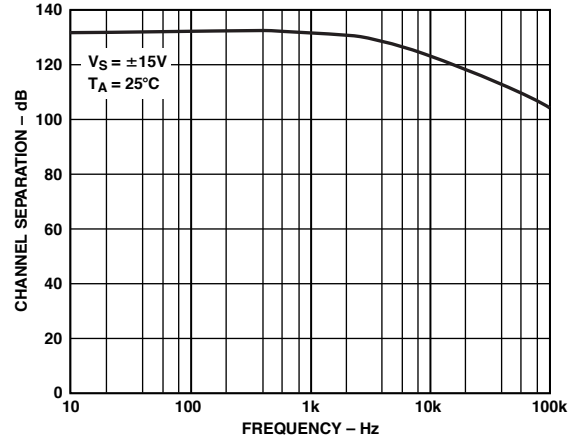

TPC 10. Channel Separation vs. Frequency

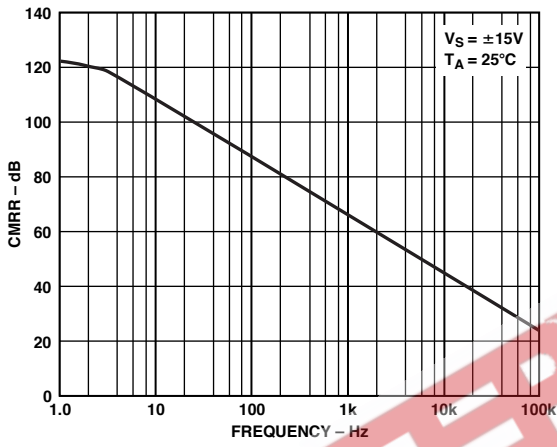

TPC 8. CMRR vs. Frequency

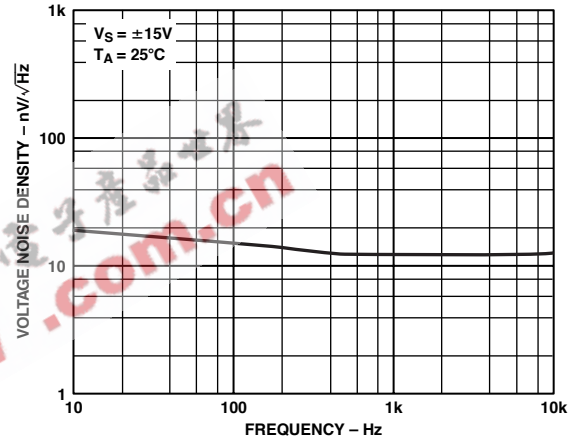

TPC 11. Voltage Noise Density vs. Frequency

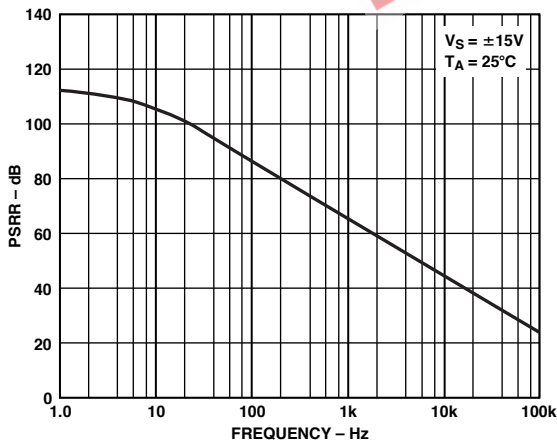

TPC 9. PSRR vs. Frequency

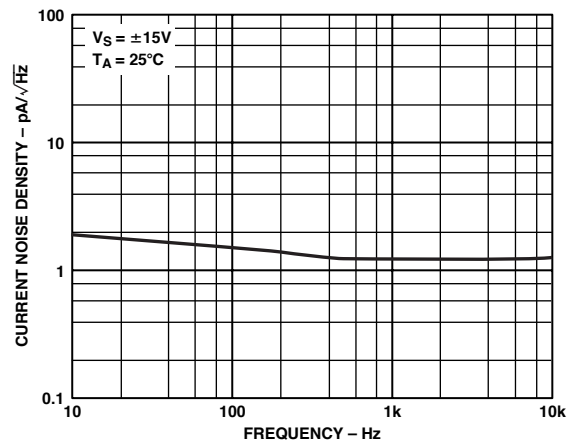

TPC 12. Noise Current Density vs. Frequency

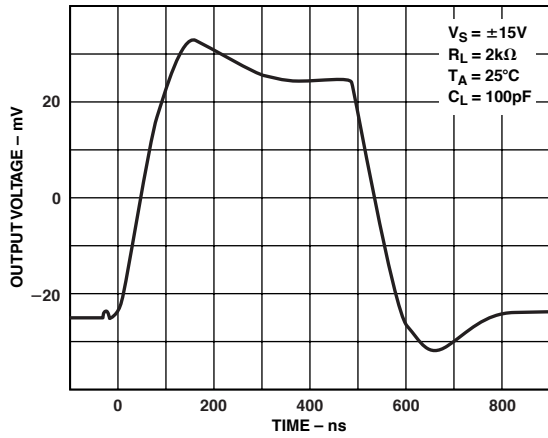

TPC 13. Transient Response

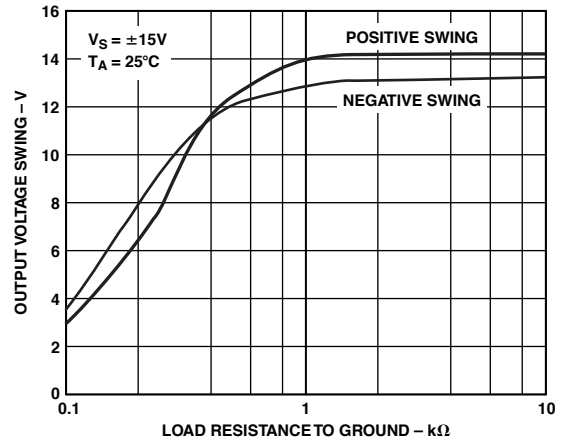

TPC 16. Output Voltage vs. Load Resistance

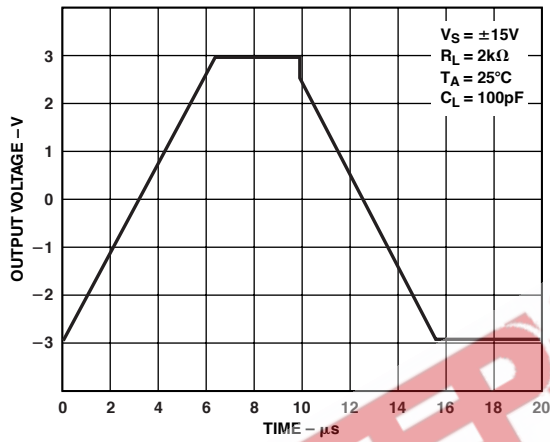

TPC 14. Voltage Follower Pulse Response

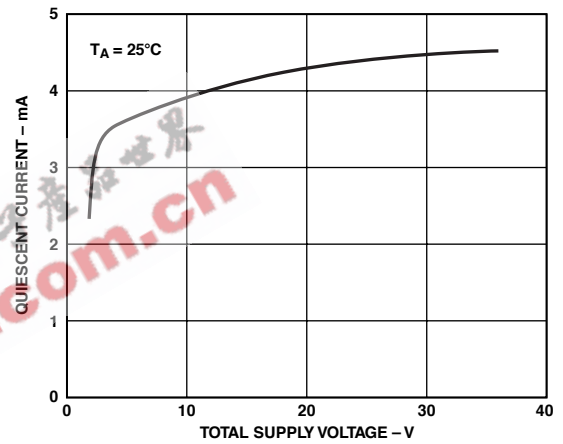

TPC 17. Quiescent Current vs. Supply Voltage

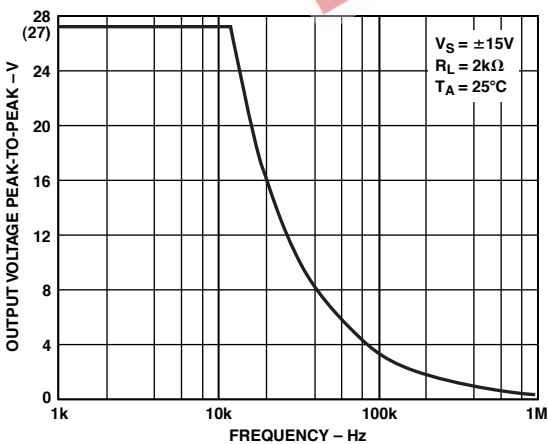

TPC 15. Maximum Output Swing vs. Frequency

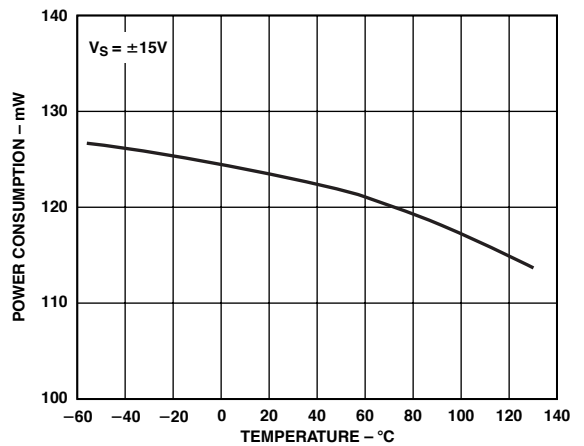

TPC 18. Power Consumption vs. Temperature

OUTLINE DIMENSIONS

Dimensions shown in inches and (mm).

14-Lead Epoxy DIP (P Suffix)

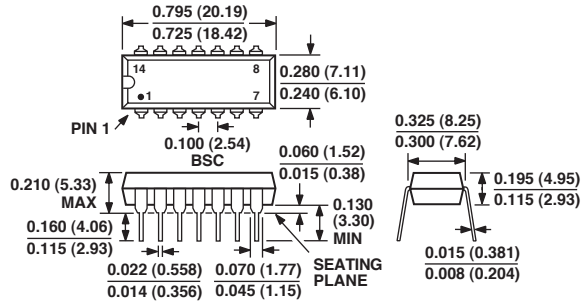

14-Lead Hermetic DIP (Y Suffix)

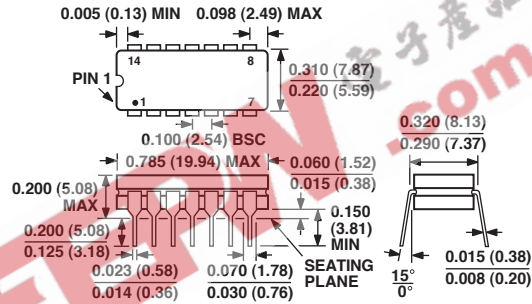

Revision History

| Location | Page |
|--|--------|
| Data Sheet changed from REV. 0 to REV. A. | |
| Change OP-09/OP-11 to OP11 | Global |
| Edits to PIN CONNECTIONS | 1 |
| Edits to Figure 1 | 1 |
| Edits to ABSOLUTE MAXIMUM RATINGS | 2 |
| Edits to ORDERING GUIDE | 2 |
| Edits to SPEC TABLES | 2-4 |
| Deletion of DICE CHARACTERISTICS | 5 |
| Deletion of WAFER TEST LIMITS Table | 5 |
| Deletion of TYPICAL ELECTRICAL CHARACTERISTICS Table | 5 |