

International
IR Rectifier

8ETU04SPbF
 8ETU04-1PbF

Ultrafast Rectifier

Features

- Ultrafast Recovery Time
- Low Forward Voltage Drop
- Low Leakage Current
- 175°C Operating Junction Temperature

$$t_{rr} = 60\text{ns}$$

$$I_{F(AV)} = 8\text{Amp}$$

$$V_R = 400\text{V}$$

Description/ Applications

International Rectifier's FRED.. series are the state of the art Ultra fast recovery rectifiers specifically designed with optimized performance of forward voltage drop and ultra fast recovery time.

The planar structure and the platinum doped life time control, guarantee the best overall performance, ruggedness and reliability characteristics.

These devices are intended for use in the output rectification stage of SMPS, UPS, DC-DC converters as well as free-wheeling diode in low voltage inverters and chopper motor drives.

Their extremely optimized stored charge and low recovery current minimize the switching losses and reduce over dissipation in the switching element and snubbers.

Absolute Maximum Ratings

Parameters	Max	Units
V_{RRM} Peak Repetitive Peak Reverse Voltage	400	V
$I_{F(AV)}$ Average Rectified Forward Current, $T_C = 155^\circ\text{C}$	8	A
I_{FSM} Non Repetitive Peak Surge Current, $T_C = 25^\circ\text{C}$	100	
I_{FRM} Peak Repetitive Forward Current	16	
T_J, T_{STG} Operating Junction and Storage Temperatures	- 65 to 175	$^\circ\text{C}$

Case Styles

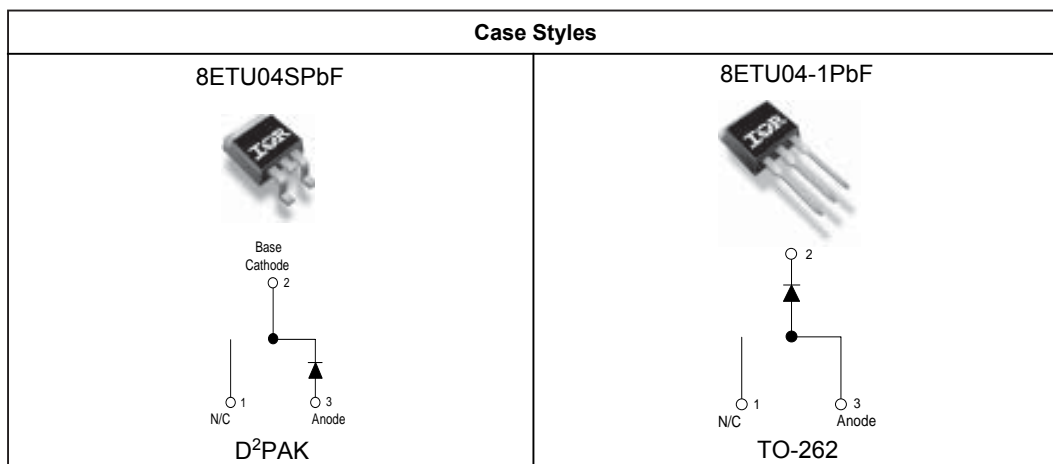

Electrical Characteristics @ T_J = 25°C (unless otherwise specified)

Parameters	Min	Typ	Max	Units	Test Conditions
V _{BR} , V _r Breakdown Voltage, Blocking Voltage	400	-	-	V	I _R = 100μA
V _F Forward Voltage	-	1.19	1.3	V	I _F = 8A
	-	0.94	1.0	V	I _F = 8A, T _J = 150°C
I _R Reverse Leakage Current	-	0.2	10	μA	V _R = V _R Rated
	-	20	500	μA	T _J = 150°C, V _R = V _R Rated
C _T Junction Capacitance	-	14	-	pF	V _R = 400V
L _S Series Inductance	-	8.0	-	nH	Measured lead to lead 5mm from package body

Dynamic Recovery Characteristics @ T_J = 25°C (unless otherwise specified)

Parameters	Min	Typ	Max	Units	Test Conditions
t _{rr} Reverse Recovery Time	-	35	60	ns	I _F = 1.0A, di _F /dt = 50A/μA, V _R = 30V
	-	43	-		T _J = 25°C
	-	67	-		T _J = 125°C
I _{RRM} Peak Recovery Current	-	2.8	-	A	T _J = 25°C
	-	6.3	-		T _J = 125°C
Q _{rr} Reverse Recovery Charge	-	60	-	nC	T _J = 25°C
	-	210	-		T _J = 125°C

Thermal - Mechanical Characteristics

Parameters	Min	Typ	Max	Units
T _J Max. Junction Temperature Range	- 65	-	175	°C
T _{Stg} Max. Storage Temperature Range	- 65	-	175	
R _{thJC} Thermal Resistance, Junction to Case	-	1.8	2.0	°C/W
R _{thJA} ^① Thermal Resistance, Junction to Ambient	-	-	50	
R _{thCS} ^② Thermal Resistance, Case to Heatsink	-	0.5	-	
Weight	-	2.0	-	g
	-	0.07	-	(oz)
Mounting Torque	6.0	-	12	Kg-cm
	5.0	-	10	lbf.in
Marking Device	8ETU04S		Case style D ² Pak	
	8ETU04-1		Case style TO-262	

① Typical Socket Mount

② Mounting Surface, Flat, Smooth and Greased

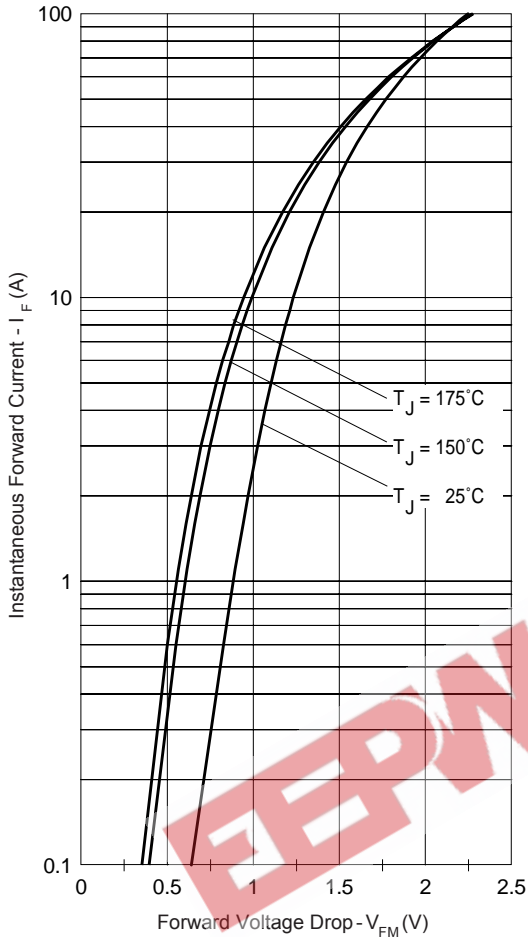

Fig. 1 - Typical Forward Voltage Drop Characteristics

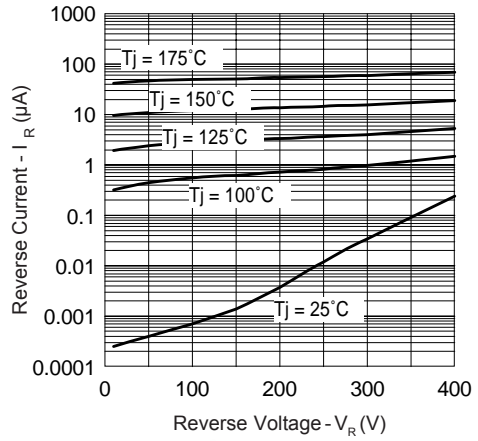

Fig. 2 - Typical Values Of Reverse Current Vs. Reverse Voltage

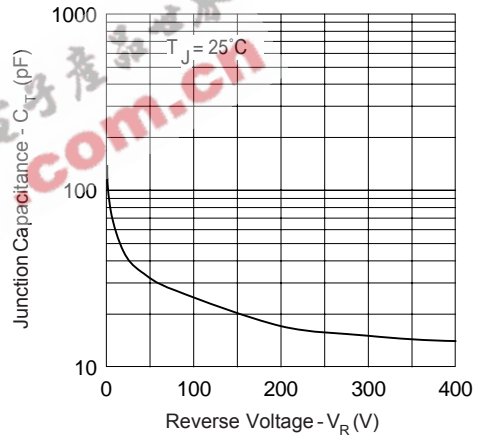

Fig. 3 - Typical Junction Capacitance Vs. Reverse Voltage

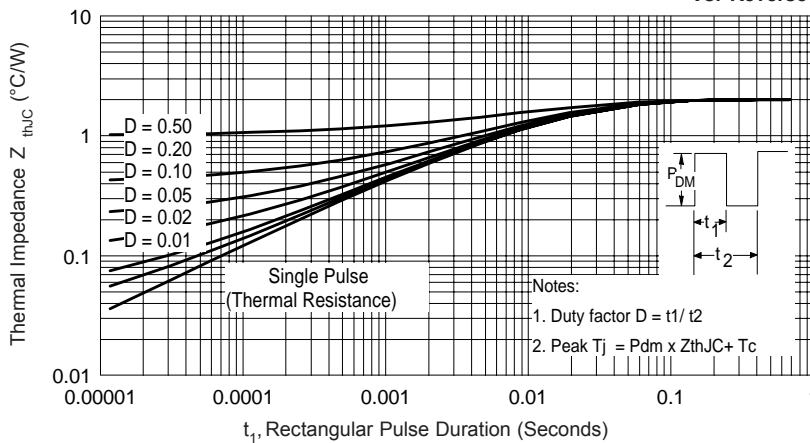

Fig. 4 - Max. Thermal Impedance Z_{thJC} Characteristics

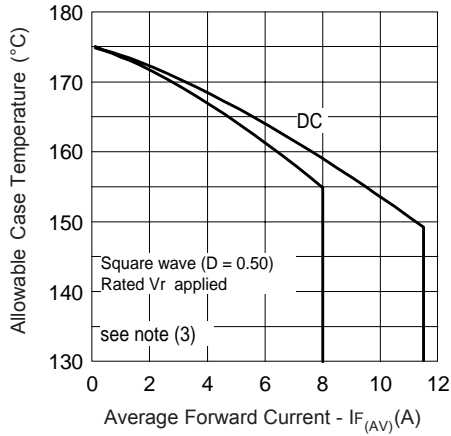

Fig. 5 - Max. Allowable Case Temperature Vs. Average Forward Current

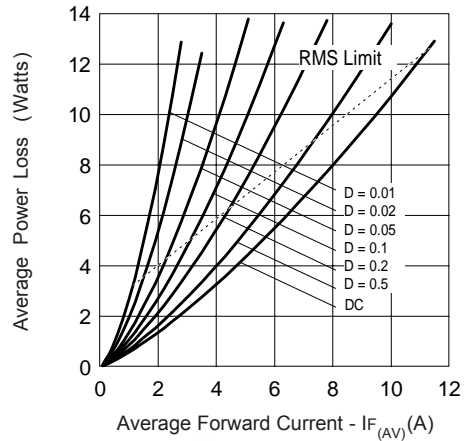

Fig. 6 - Forward Power Loss Characteristics

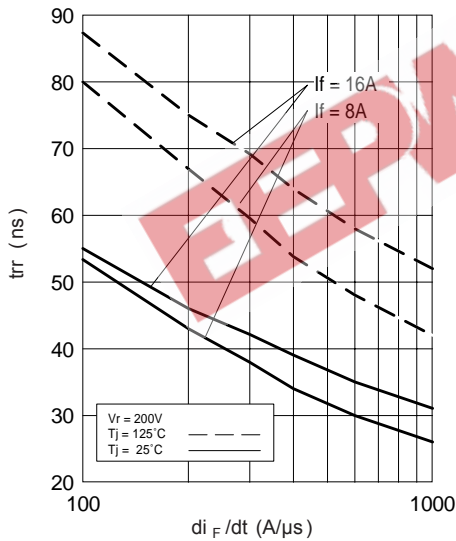

Fig. 7 - Typical Reverse Recovery vs. di_F/dt

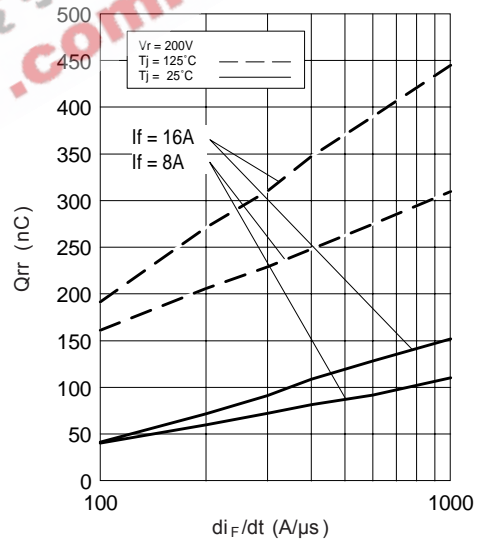

Fig. 8 - Typical Stored Charge vs. di_F/dt

(3) Formula used: $T_c = T_j - (P_d + P_{d_{REV}}) \times R_{thJC}$;

P_d = Forward Power Loss = $I_{F(AV)} \times V_{FM} @ (I_{F(AV)}/D)$ (see Fig. 6);

$P_{d_{REV}}$ = Inverse Power Loss = $V_{R1} \times I_R (1-D)$; $I_R @ V_{R1}$ = rated V_R

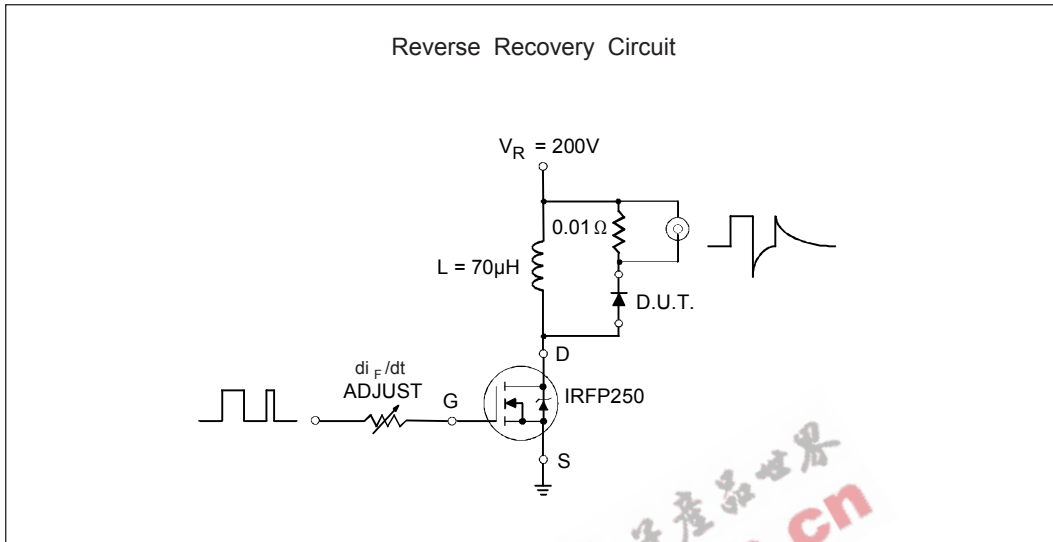

Fig. 9- Reverse Recovery Parameter Test Circuit

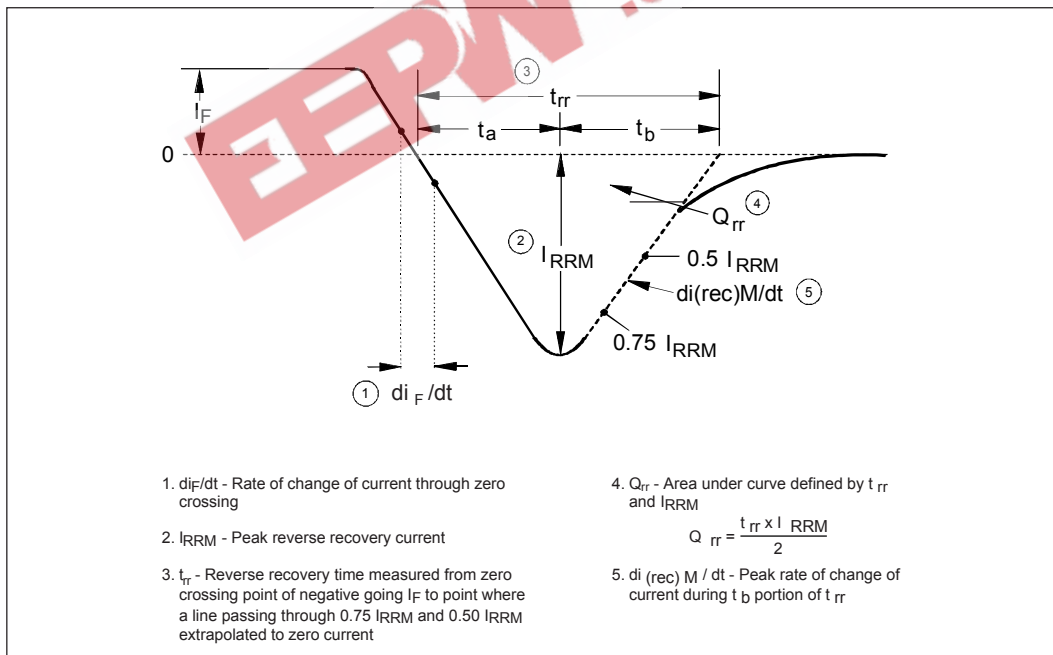
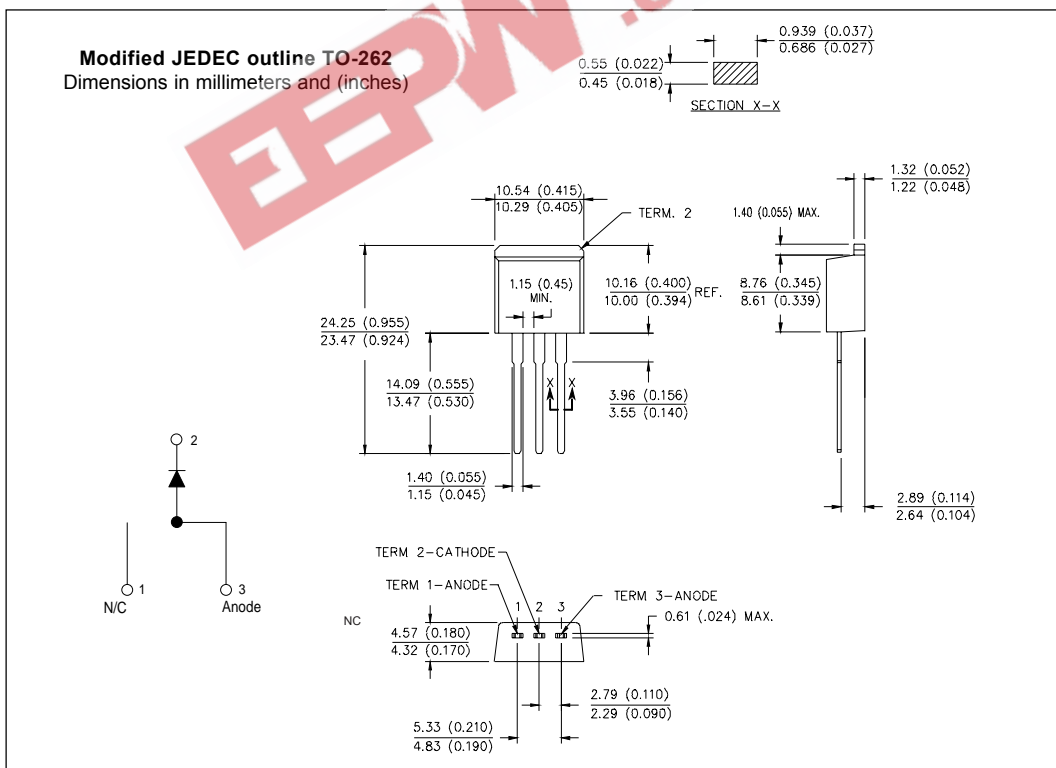
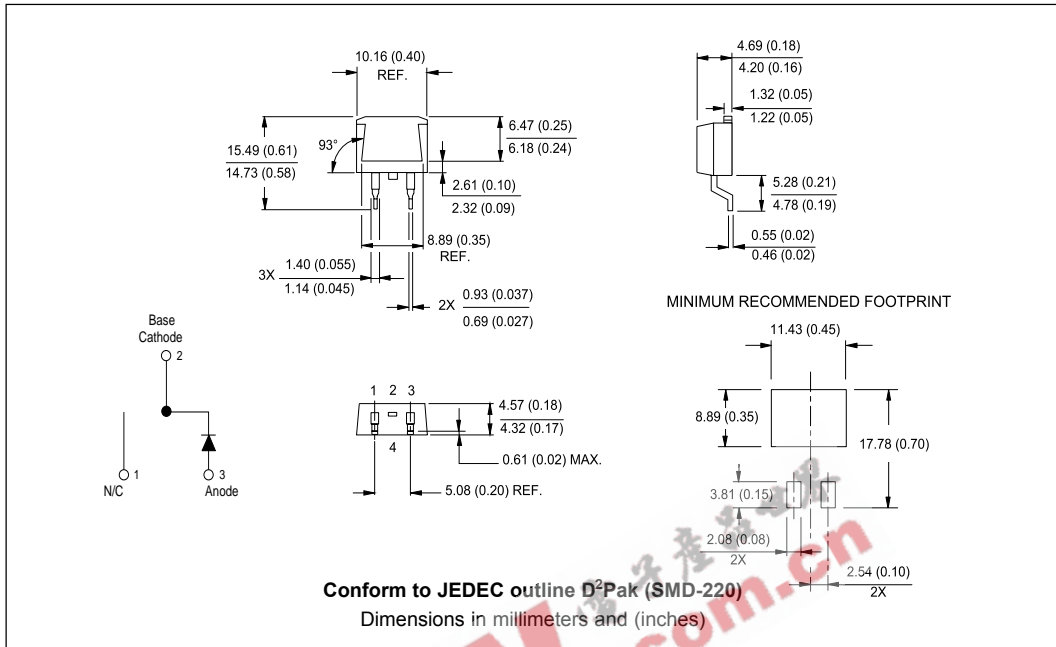

Fig. 10 - Reverse Recovery Waveform and Definitions

Outlines Table



Part Marking Information

D²PAK

EXAMPLE: THIS IS A 8ETU04S
LOT CODE 8024
ASSEMBLED ON WW 02, 2000

Note: "P" in assembly line position indicates "Lead-Free"

INTERNATIONAL RECTIFIER LOGO

PART NUMBER

DATE CODE
YEAR 0 = 2000
WEEK 02
P = LEAD-FREE

ASSEMBLY LOT CODE

TO-262

EXAMPLE: THIS IS A 8ETU04-1
LOT CODE 8024
ASSEMBLED ON WW 02, 2000

Note: "P" in assembly line position indicates "Lead-Free"

INTERNATIONAL RECTIFIER LOGO

PART NUMBER

DATE CODE
YEAR 0 = 2000
WEEK 02
P = LEAD-FREE

ASSEMBLY LOT CODE

Tape & Reel Information

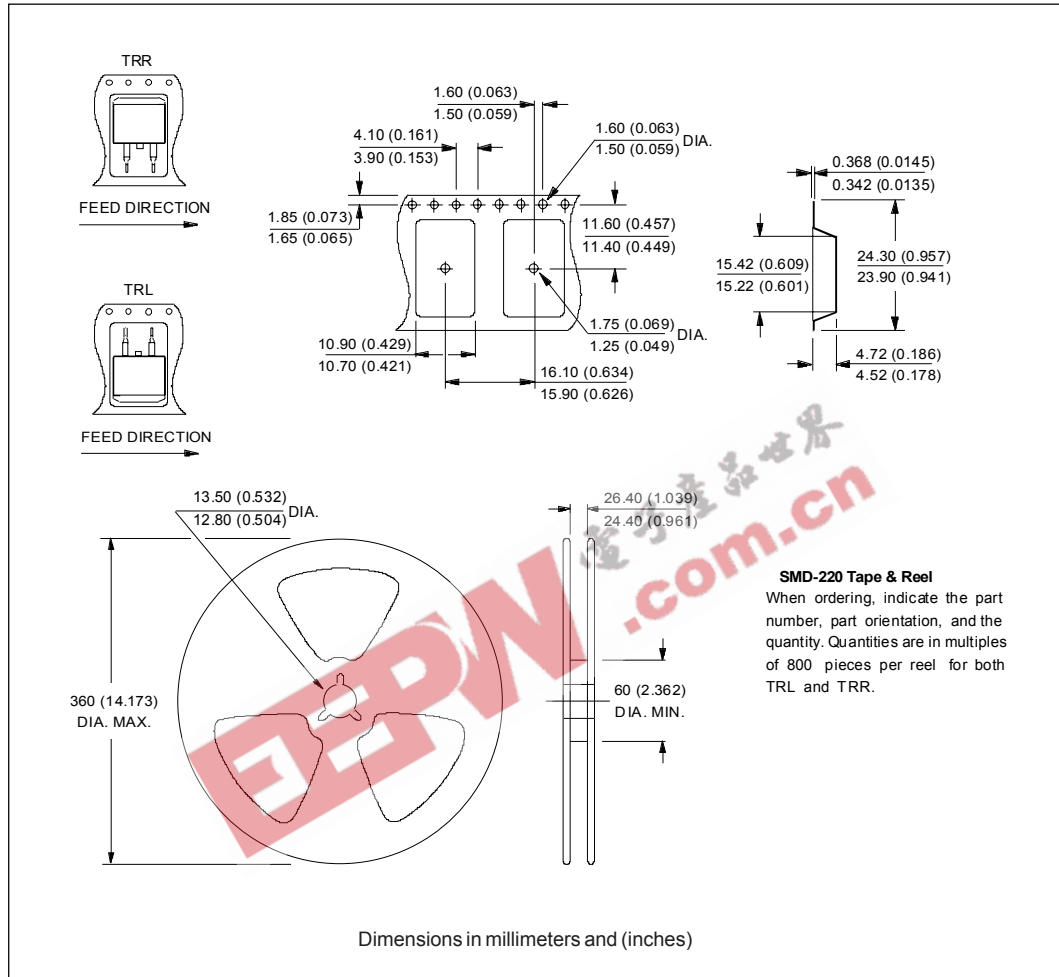

Ordering Information Table

Device Code																	
	<table border="1" style="margin: auto;"> <tr> <td style="padding: 5px;">8</td> <td style="padding: 5px;">E</td> <td style="padding: 5px;">T</td> <td style="padding: 5px;">U</td> <td style="padding: 5px;">04</td> <td style="padding: 5px;">S</td> <td style="padding: 5px;">TRL</td> <td style="padding: 5px;">PbF</td> </tr> <tr> <td style="text-align: center;">①</td> <td style="text-align: center;">②</td> <td style="text-align: center;">③</td> <td style="text-align: center;">④</td> <td style="text-align: center;">⑤</td> <td style="text-align: center;">⑥</td> <td style="text-align: center;">⑦</td> <td style="text-align: center;">⑧</td> </tr> </table>	8	E	T	U	04	S	TRL	PbF	①	②	③	④	⑤	⑥	⑦	⑧
8	E	T	U	04	S	TRL	PbF										
①	②	③	④	⑤	⑥	⑦	⑧										
1	- Current Rating (8A)																
2	- E = Single Diode																
3	- T = TO-220, D ² Pak																
4	- U = Ultrafast Rectifier																
5	- Voltage Rating (04 = 400V)																
6	- <ul style="list-style-type: none"> • S = D²Pak • -1 = TO-262 																
7	- <ul style="list-style-type: none"> • none = Tube (50 pieces) • TRL = Tape & Reel (Left Oriented, for D²PAk package) • TRR = Tape & Reel (Right Oriented, for D²PAk package) 																
8	- <ul style="list-style-type: none"> • none = Standard Production • PbF = Lead-Free 																

Data and specifications subject to change without notice.
 This product has been designed and qualified for Industrial Level and Lead-Free.
 Qualification Standards can be found on IR's Web site.