

# P4C1256

## HIGH SPEED 32K x 8

### STATIC CMOS RAM

#### FEATURES

- High Speed (Equal Access and Cycle Times)
  - 12/15/20/25/35 ns (Commercial)
  - 15/20/25/35/45 ns (Industrial)
  - 20/25/35/45/55/70 ns (Military)
- Low Power
- Single 5V±10% Power Supply
- Easy Memory Expansion Using CE and OE Inputs
- Common Data I/O
- Three-State Outputs
- Fully TTL Compatible Inputs and Outputs
- Advanced CMOS Technology
- Fast  $t_{OE}$
- Automatic Power Down
- Packages
  - 28-Pin 300 mil DIP, SOJ, TSOP
  - 28-Pin 300 mil Ceramic DIP
  - 28-Pin 600 mil Ceramic DIP
  - 28-Pin CERPACK
  - 28-Pin SOP
  - 28-Pin LCC (350 mil x 550 mil)
  - 32-Pin LCC (450 mil x 550 mil)

#### DESCRIPTION

The P4C1256 is a 262,144-bit high-speed CMOS static RAM organized as 32Kx8. The CMOS memory requires no clocks or refreshing, and has equal access and cycle times. Inputs are fully TTL-compatible. The RAM operates from a single 5V±10% tolerance power supply.

Access times as fast as 12 nanoseconds permit greatly enhanced system operating speeds. CMOS is utilized to reduce power consumption to a low level. The P4C1256 is a member of a family of PACE RAM™ products offering fast access times.

The P4C1256 device provides asynchronous operation with matching access and cycle times. Memory locations are specified on address pins  $A_0$  to  $A_{14}$ . Reading is accomplished by device selection (CE and output enabling (OE) while write enable (WE) remains HIGH. By presenting the address under these conditions, the data in the addressed memory location is presented on the data input/output pins. The input/output pins stay in the HIGH Z state when either CE or OE is HIGH or WE is LOW.

Package options for the P4C1256 include 28-pin 300 mil DIP, SOJ and TSOP packages. For military temperature range, Ceramic DIP and LCC packages are available.

#### FUNCTIONAL BLOCK DIAGRAM



#### PIN CONFIGURATIONS



### MAXIMUM RATINGS<sup>(1)</sup>

Symbol	Parameter	Value	Unit
V <sub>CC</sub>	Power Supply Pin with Respect to GND	-0.5 to +7	V
V <sub>TERM</sub>	Terminal Voltage with Respect to GND (up to 7.0V)	-0.5 to V <sub>CC</sub> +0.5	V
T <sub>A</sub>	Operating Temperature	-55 to +125	°C

Symbol	Parameter	Value	Unit
T <sub>BIAS</sub>	Temperature Under Bias	-55 to +125	°C
T <sub>STG</sub>	Storage Temperature	-65 to +150	°C
P <sub>T</sub>	Power Dissipation	1.0	W
I <sub>OUT</sub>	DC Output Current	50	mA

### RECOMMENDED OPERATING TEMPERATURE AND SUPPLY VOLTAGE

Grade(2)	Ambient Temperature	GND	V <sub>CC</sub>
Military	-55°C to +125°C	0V	5.0V ± 10%
Industrial	-40°C to +85°C	0V	5.0V ± 10%
Commercial	0°C to +70°C	0V	5.0V ± 10%

### CAPACITANCES<sup>(4)</sup>

V<sub>CC</sub> = 5.0V, T<sub>A</sub> = 25°C, f = 1.0MHz

Symbol	Parameter	Conditions	Typ.	Unit
C <sub>IN</sub>	Input Capacitance	V <sub>IN</sub> = 0V	8	pF
C <sub>OUT</sub>	Output Capacitance	V <sub>OUT</sub> = 0V	10	pF

### DC ELECTRICAL CHARACTERISTICS

Over recommended operating temperature and supply voltage<sup>(2)</sup>

Symbol	Parameter	Test Conditions	P4C1256		P4C1256L		Unit
			Min	Max	Min	Max	
V <sub>IH</sub>	Input High Voltage		2.2	V <sub>CC</sub> +0.5	2.2	V <sub>CC</sub> +0.5	V
V <sub>IL</sub>	Input Low Voltage		-0.5 <sup>(3)</sup>	0.8	-0.5 <sup>(3)</sup>	0.8	V
V <sub>HC</sub>	CMOS Input High Voltage		V <sub>CC</sub> -0.2	V <sub>CC</sub> +0.5	V <sub>CC</sub> -0.2	V <sub>CC</sub> +0.5	V
V <sub>LC</sub>	CMOS Input Low Voltage		-0.5 <sup>(3)</sup>	0.2	-0.5 <sup>(3)</sup>	0.2	V
V <sub>OL</sub>	Output Low Voltage (TTL Load)	I <sub>OL</sub> = +8 mA, V <sub>CC</sub> = Min.		0.4		0.4	V
V <sub>OH</sub>	Output High Voltage (TTL Load)	I <sub>OH</sub> = -4 mA, V <sub>CC</sub> = Min.	2.4		2.4		V
I <sub>LI</sub>	Input Leakage Current	V <sub>CC</sub> = Max. Mil.	-10	+10	-5	+5	µA
		V <sub>IN</sub> = GND to V <sub>CC</sub> Ind./Com'l.	-5	+5	n/a	n/a	
I <sub>LO</sub>	Output Leakage Current	V <sub>CC</sub> = Max., Mil.	-10	+10	-5	+5	µA
		CE = V <sub>IH</sub> , Ind./Com'l. V <sub>OUT</sub> = GND to V <sub>CC</sub>	-5	+5	n/a	n/a	
I <sub>SB</sub>	Standby Power Supply Current (TTL Input Levels)	CE ≥ V <sub>IH</sub> Mil.	—	45	—	30	mA
		V <sub>CC</sub> = Max, Ind./Com'l. f = Max., Outputs Open	—	30	—	n/a	
I <sub>SB1</sub>	Standby Power Supply Current (CMOS Input Levels)	CE ≥ V <sub>HC</sub> Mil.	—	20	—	10	mA
		V <sub>CC</sub> = Max, Ind./Com'l. f = 0, Outputs Open V <sub>IN</sub> ≤ V <sub>LC</sub> or V <sub>IN</sub> ≥ V <sub>HC</sub>	—	10	—	n/a	

N/A = Not Applicable

**DATA RETENTION CHARACTERISTICS (P4C1256L Military Temperature Only)**

Symbol	Parameter	Test Conditions	Min	Typ.*		Max		Unit
				$V_{CC} = 2.0V$	$V_{CC} = 3.0V$	$V_{CC} = 2.0V$	$V_{CC} = 3.0V$	
$V_{DR}$	$V_{CC}$ for Data Retention		2.0					V
$I_{CCDR}$	Data Retention Current	$CE \geq V_{CC} - 0.2V,$ $V_{IN} \geq V_{CC} - 0.2V$ or $V_{IN} \leq 0.2V$		10	15	100	200	$\mu A$
$t_{CDR}$	Chip Deselect to Data Retention Time		0					ns
$t_R^\dagger$	Operation Recovery Time		$t_{RC}^\S$					ns

\* $T_A = +25^\circ C$

$t_{RC}^\S =$  Read Cycle Time

$^\dagger$  This parameter is guaranteed but not tested.

**DATA RETENTION WAVEFORM**



**POWER DISSIPATION CHARACTERISTICS VS. SPEED**

Symbol	Parameter	Temperature Range	-12	-15	-20	-25	-35	-45	-55	-70	Unit
			Commercial	Industrial	Military						
$I_{CC}$	Dynamic Operating Current*	Commercial	170	160	155	150	145	N/A	N/A	N/A	mA
		Industrial	N/A	170	165	160	155	150	N/A	N/A	mA
		Military	N/A	N/A	170	165	160	155	150	150	mA

\* $V_{CC} = 5.5V$ . Tested with outputs open.  $f =$  Max. Switching inputs are 0V and 3V.  $CE = V_{IL}$ ,  $OE = V_{IH}$ .

### AC ELECTRICAL CHARACTERISTICS—READ CYCLE

( $V_{CC} = 5V \pm 10\%$ , All Temperature Ranges)<sup>(2)</sup>

Sym.	Parameter	-12		-15		-20		-25		-35		-45		-55		-70		Unit
		Min	Max	Min	Max	Min	Max	Min	Max	Min	Max	Min	Max	Min	Max	Min	Max	
$t_{RC}$	Read Cycle Time	12		15		20		25		35		45		55		70		ns
$t_{AA}$	Address Access Time		12		15		20		25		35		45		55		70	ns
$t_{AC}$	Chip Enable Access Time		12		15		20		25		35		45		55		70	ns
$t_{OH}$	Output Hold from Address Change	2		2		2		3		3		3		3		3		ns
$t_{LZ}$	Chip Enable to Output in Low Z	2		2		2		3		3		3		3		3		ns
$t_{HZ}$	Chip Disable to Output in High Z		5		8		9		11		15		20		25		30	ns
$t_{OE}$	Output Enable Low to Data Valid		5		7		9		10		15		20		25		30	ns
$t_{OLZ}$	Output Enable Low to Low Z	0		0		0		0		0		0		0		0		ns
$t_{OHZ}$	Output Enable High to High Z		5		7		9		11		15		20		25		30	ns
$t_{PU}$	Chip Enable to Power Up Time	0		0		0		0		0		0		0		0		ns
$t_{PD}$	Chip Disable to Power Down Time		12		15		20		20		20		25		30		35	ns

**TIMING WAVEFORM OF READ CYCLE NO. 1 (OE CONTROLLED)<sup>(5)</sup>**



**TIMING WAVEFORM OF READ CYCLE NO. 2 (ADDRESS CONTROLLED)<sup>(5,6)</sup>**

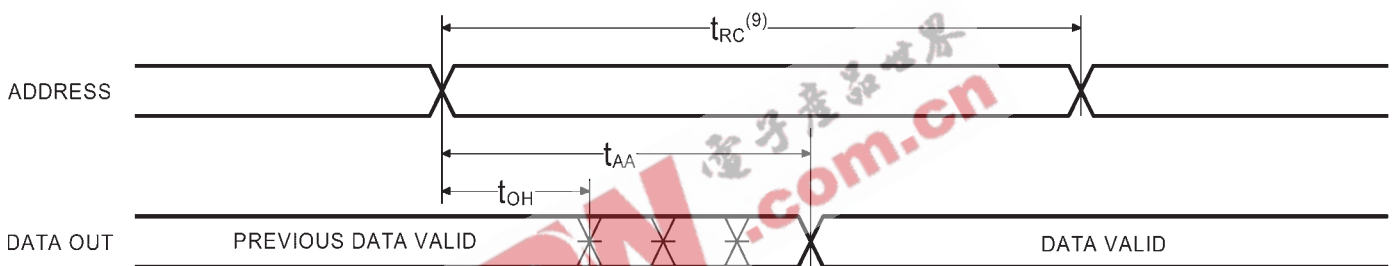

**TIMING WAVEFORM OF READ CYCLE NO. 3 (CE CONTROLLED)<sup>(5,7)</sup>**



**Notes:**

1. Stresses greater than those listed under MAXIMUM RATINGS may cause permanent damage to the device. This is a stress rating only and functional operation of the device at these or any other conditions above those indicated in the operational sections of this specification is not implied. Exposure to MAXIMUM rating conditions for extended periods may affect reliability.
2. Extended temperature operation guaranteed with 400 linear feet per minute of air flow.
3. Transient inputs with  $V_{IL}$  and  $I_{IL}$  not more negative than  $-3.0V$  and  $-100mA$ , respectively, are permissible for pulse widths up to 20ns.
4. This parameter is sampled and not 100% tested.
5. WE is HIGH for READ cycle.
6. CE is LOW and OE is LOW for READ cycle.
7. ADDRESS must be valid prior to, or coincident with CE transition LOW.
8. Transition is measured  $\pm 200$  mV from steady state voltage prior to change, with loading as specified in Figure 1. This parameter is sampled and not 100% tested.
9. Read Cycle Time is measured from the last valid address to the first transitioning address.

### AC CHARACTERISTICS—WRITE CYCLE

( $V_{CC} = 5V \pm 10\%$ , All Temperature Ranges)<sup>(2)</sup>

Sym.	Parameter	-12		-15		-20		-25		-35		-45		-55		-70		Unit
		Min	Max	Min	Max	Min	Max	Min	Max	Min	Max	Min	Max	Min	Max	Min	Max	
$t_{WC}$	Write Cycle Time	12		15		20		25		35		45		55		70		ns
$t_{CW}$	Chip Enable Time to End of Write	9		10		15		18		22		30		35		40		ns
$t_{AW}$	Address Valid to End of Write	9		10		15		20		25		35		40		45		ns
$t_{AS}$	Address Set-up Time	0		0		0		0		0		0		0		0		ns
$t_{WP}$	Write Pulse Width	9		11		15		18		22		25		30		35		ns
$t_{AH}$	Address Hold Time	0		0		0		0		0		0		0		0		ns
$t_{DW}$	Data Valid to End of Write	8		9		11		13		15		20		25		30		ns
$t_{DH}$	Date Hold Time	0		0		0		0		0		0		0		0		ns
$t_{WZ}$	Write Enable to Output in High Z		7		8		10		11		15		18		25		30	ns
$t_{OW}$	Output Active from End of Write	3		3		3		3		5		5		0		0		ns

### TIMING WAVEFORM OF WRITE CYCLE NO. 1 (WE CONTROLLED)<sup>(10,11)</sup>

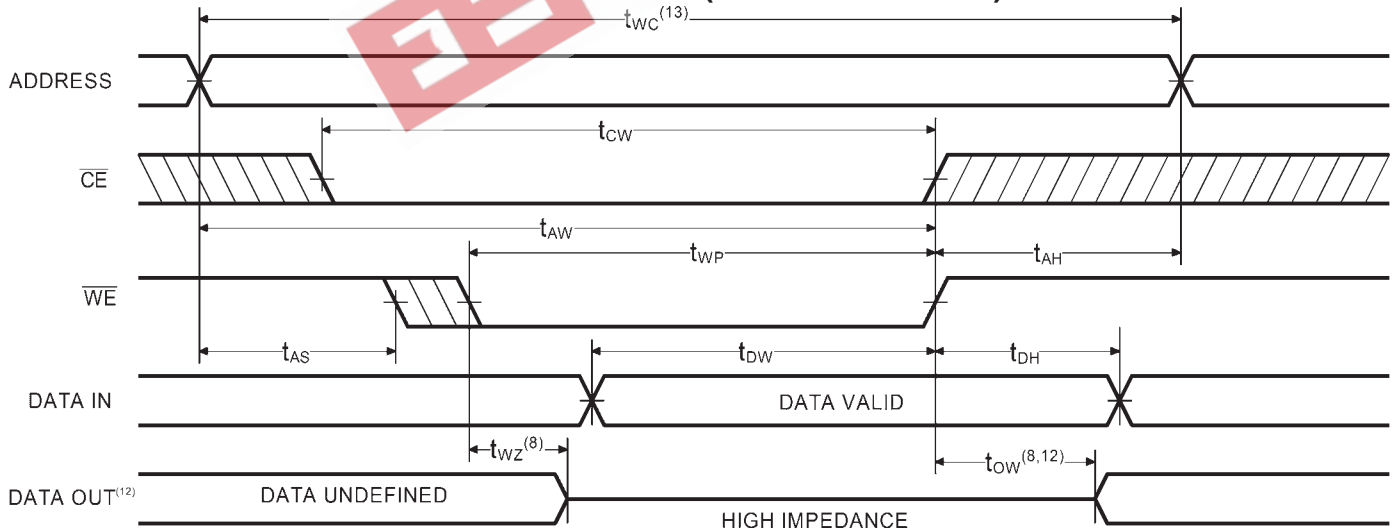

**TIMING WAVEFORM OF WRITE CYCLE NO. 2 (CE CONTROLLED)<sup>(10)</sup>**

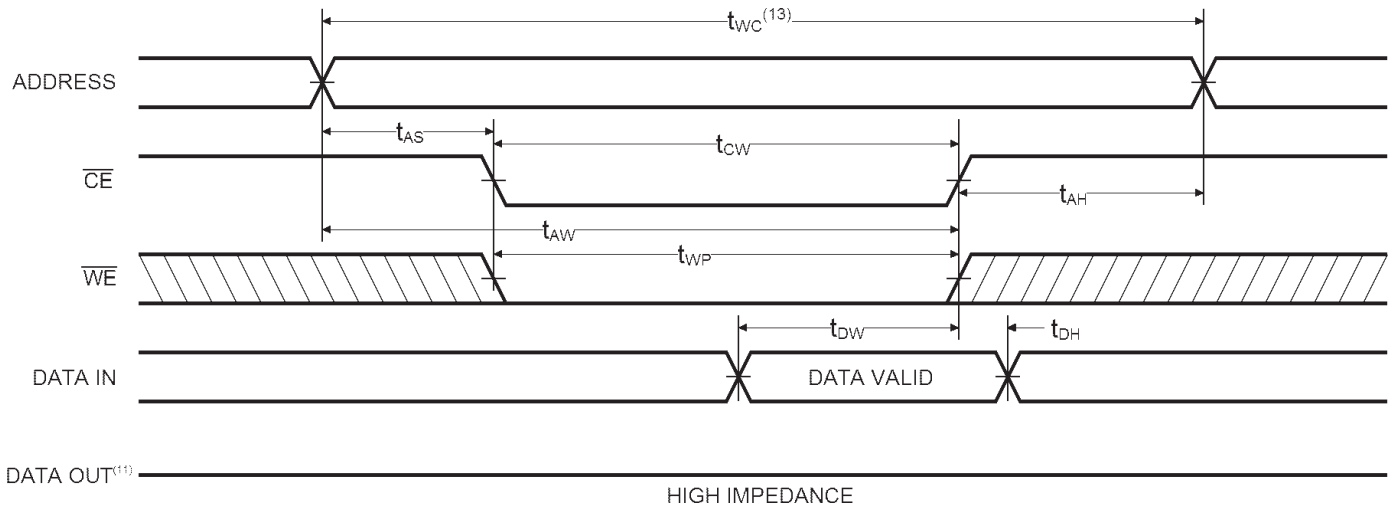

**Notes:**

- 10. CE and WE must be LOW for WRITE cycle.
- 11. OE is LOW for this WRITE cycle to show  $t_{wz}$  and  $t_{ow}$ .
- 12. If CE goes HIGH simultaneously with WE HIGH, the output remains

- in a high impedance state
- 13. Write Cycle Time is measured from the last valid address to the first transitioning address.



### AC TEST CONDITIONS

Input Pulse Levels	GND to 3.0V
Input Rise and Fall Times	3ns
Input Timing Reference Level	1.5V
Output Timing Reference Level	1.5V
Output Load	See Figures 1 and 2

### TRUTH TABLE

Mode	CE	OE	WE	I/O	Power
Standby	H	X	X	High Z	Standby
Standby	X	X	X	High Z	Standby
D <sub>OUT</sub> Disabled	L	H	H	High Z	Active
Read	L	L	H	D <sub>OUT</sub>	Active
Write	L	X	L	High Z	Active



Figure 1. Output Load



Figure 2. Thevenin Equivalent

\* including scope and test fixture.

**Note:**

Because of the ultra-high speed of the P4C1256, care must be taken when testing this device; an inadequate setup can cause a normal functioning part to be rejected as faulty. Long high-inductance leads that cause supply bounce must be avoided by bringing the V<sub>CC</sub> and ground planes directly up to the contactor fingers. A 0.01 μF high frequency capacitor is also required between V<sub>CC</sub> and ground. To avoid signal reflections, proper termination

must be used; for example, a 50Ω test environment should be terminated into a 50Ω load with 1.73V (Thevenin Voltage) at the comparator input, and a 116Ω resistor must be used in series with D<sub>OUT</sub> to match 166Ω (Thevenin Resistance).



**ORDERING INFORMATION**



**SELECTION GUIDE**

The P4C1256 is available in the following temperature, speed and package options. The P4C1256L is available only over the military temperature range. \*\*

Temperature Range	Package	Speed							
		12	15	20	25	35	45	55	70
Commercial	Plastic DIP	-12PC	-15PC	-20PC	-25PC	-35PC	N/A	N/A	N/A
	Plastic SOJ	-12JC	-15JC	-20JC	-25JC	-35JC	N/A	N/A	N/A
	Plastic TSOP	-12TC	-15TC	-20TC	-25TC	-35TC	N/A	N/A	N/A
	Plastic SOP (S11-1)	-12SC	-15SC	-20SC	-25SC	-35SC	N/A	N/A	N/A
	Plastic SOP (S11-3)	-12SSC	-15SSC	-20SSC	-25SSC	-35SSC	N/A	N/A	N/A
Industrial	Plastic DIP	N/A	-15PI	-20PI	-25PI	-35PI	-45PI	N/A	N/A
	Plastic SOJ	N/A	-15JI	-20JI	-25JI	-35JI	-45JI	N/A	N/A
	Plastic TSOP	N/A	-15TI	-20TI	-25TI	-35TI	-45TI	N/A	N/A
	Plastic SOP (S11-1)	N/A	-15SI	-20SI	-25SI	-35SI	-45SI	N/A	N/A
	Plastic SOP (S11-3)	N/A	-15SSI	-20SSI	-25SSI	-35SSI	-45SSI	N/A	N/A

\* Military temperature range with MIL-STD-883, Class B processing.  
 \*\* For RoHS compliant plastic products, the suffix "LF" (Lead Free) should be added to the part number.  
 N/A = Not Available

### SELECTION GUIDE (CONTINUED)

Temperature Range	Package	Speed							
		12	15	20	25	35	45	55	70
Military Temperature	Side Brazed DIP (300 mil)	N/A	N/A	-20CM	-25CM	-35CM	-45CM	-55CM	-70CM
	Side Brazed DIP (600 mil)	N/A	N/A	-20CWM	-25CWM	-35CWM	-45CWM	-55CWM	-70CWM
	Ceramic DIP	N/A	N/A	-20DM	-25DM	-35DM	-45DM	-55DM	-70DM
	CERPACK	N/A	N/A	-20FM	-25FM	-35FM	-45FM	-55FM	-70FM
	LCC (28-Pin)	N/A	N/A	-20L28M	-25L28M	-35L28M	-45L28M	-55L28M	-70L28M
	LCC (32-Pin)	N/A	N/A	-20L32M	-25L32M	-35L32M	-45L32M	-55L32M	-70L32M
Military Processed*	Side Brazed DIP (300 mil)	N/A	N/A	-20CMB	-25CMB	-35CMB	-45CMB	-55CMB	-70CMB
	Side Brazed DIP (600 mil)	N/A	N/A	-20CWMB	-25CWMB	-35CWMB	-45CWMB	-55CWMB	-70CWMB
	Ceramic DIP	N/A	N/A	-20DMB	-25DMB	-35DMB	-45DMB	-55DMB	-70DMB
	CERPACK	N/A	N/A	-20FMB	-25FMB	-35FMB	-45FMB	-55FMB	-70FMB
	LCC (28-Pin)	N/A	N/A	-20L28MB	-25L28MB	-35L28MB	-45L28MB	-55L28MB	-70L28MB
	LCC (32-Pin)	N/A	N/A	-20L32MB	-25L32MB	-35L32MB	-45L32MB	-55L32MB	-70L32MB

### LCC PIN CONFIGURATIONS



28 LCC (L5)



32 LCC (L6)



TSOP (T1)

Pkg #	<b>C5</b>	
# Pins	28 (300 mil)	
Symbol	<b>Min</b>	<b>Max</b>
A	-	0.225
b	0.014	0.026
b2	0.045	0.065
C	0.008	0.018
D	-	1.485
E	0.240	0.310
eA	0.300 BSC	
e	0.100 BSC	
L	0.125	0.200
Q	0.015	0.070
S1	0.005	-
S2	0.005	-

**SIDE BRAZED CERAMIC DUAL IN-LINE PACKAGE (300 Mils)**



Pkg #	<b>C5-1</b>	
# Pins	28 (600 mil)	
Symbol	<b>Min</b>	<b>Max</b>
A	-	0.232
b	0.014	0.026
b2	0.045	0.065
C	0.008	0.018
D	-	1.490
E	0.500	0.610
eA	0.600 BSC	
e	0.100 BSC	
L	0.125	0.200
Q	0.015	0.060
S1	0.005	-
S2	0.005	-

**SIDE BRAZED CERAMIC DUAL IN-LINE PACKAGE (600 Mils)**



Pkg #	D5-2	
# Pins	28 (300 mil)	
Symbol	Min	Max
A	-	0.225
b	0.014	0.026
b2	0.045	0.065
C	0.008	0.018
D	-	1.485
E	0.240	0.310
eA	0.300 BSC	
e	0.100 BSC	
L	0.125	0.200
Q	0.015	0.060
S1	0.005	-
$\alpha$	0°	15°

**CERDIP DUAL IN-LINE PACKAGE**



Pkg #	F4	
# Pins	28	
Symbol	Min	Max
A	0.060	0.090
b	0.015	0.022
c	0.004	0.009
D	-	0.730
E	0.330	0.380
e	0.050 BSC	
k	0.005	0.018
L	0.250	0.370
Q	0.026	0.045
S	-	0.085
S1	0.005	-

**CERPACK CERAMIC FLAT PACKAGE**

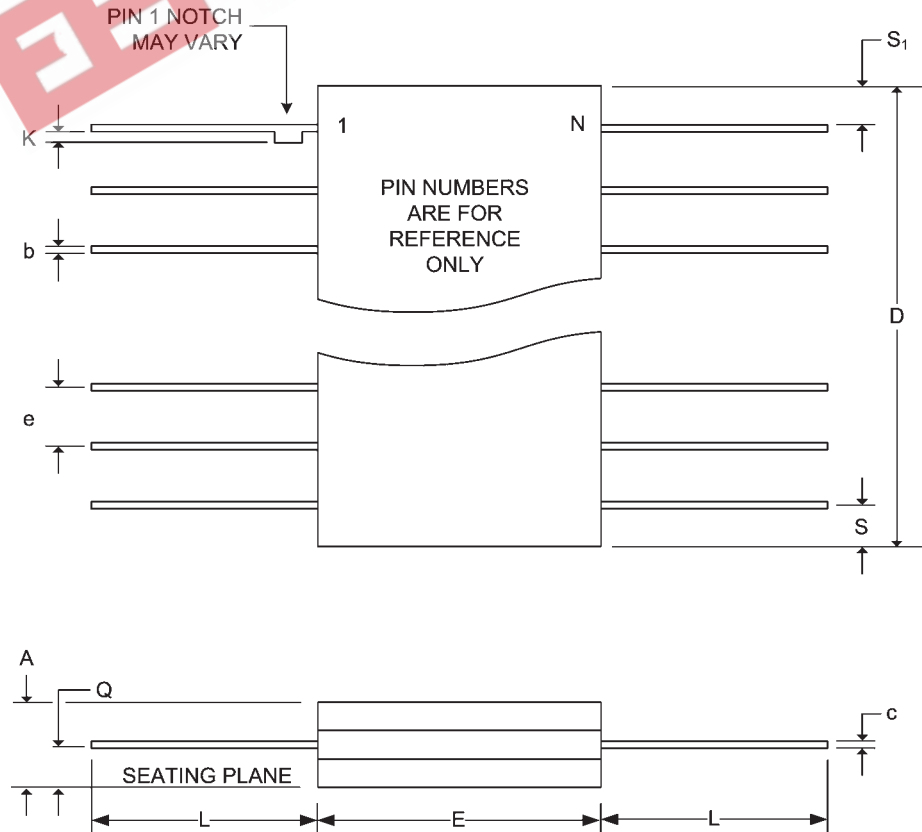

Pkg #	<b>J5</b>	
# Pins	28 (300 mil)	
Symbol	<b>Min</b>	<b>Max</b>
A	0.120	0.148
A1	0.078	-
b	0.014	0.020
C	0.007	0.011
D	0.700	0.730
e	0.050 BSC	
E	0.335 BSC	
E1	0.292	0.300
E2	0.267 BSC	
Q	0.025	-

**SOJ SMALL OUTLINE IC PACKAGE**



Pkg #	<b>L5</b>	
# Pins	28	
Symbol	<b>Min</b>	<b>Max</b>
A	0.060	0.075
A1	0.050	0.065
B1	0.022	0.028
D	0.342	0.358
D1	0.200 BSC	
D2	0.100 BSC	
D3	-	0.358
E	0.540	0.560
E1	0.400 BSC	
E2	0.200 BSC	
E3	-	0.558
e	0.050 BSC	
h	0.040 REF	
j	0.020 REF	
L	0.045	0.055
L1	0.045	0.055
L2	0.075	0.095
ND	5	
NE	9	

**RECTANGULAR LEADLESS CHIP CARRIER (28 Pins)**



Pkg #	L6	
# Pins	32	
Symbol	Min	Max
A	0.060	0.075
A1	0.050	0.065
B1	0.022	0.028
D	0.442	0.458
D1	0.300 BSC	
D2	0.150 BSC	
D3	-	0.458
E	0.540	0.560
E1	0.400 BSC	
E2	0.200 BSC	
E3	-	0.558
e	0.050 BSC	
h	0.040 REF	
j	0.020 REF	
L	0.045	0.055
L1	0.045	0.055
L2	0.075	0.095
ND	7	
NE	9	

RECTANGULAR LEADLESS CHIP CARRIER (32 Pins)

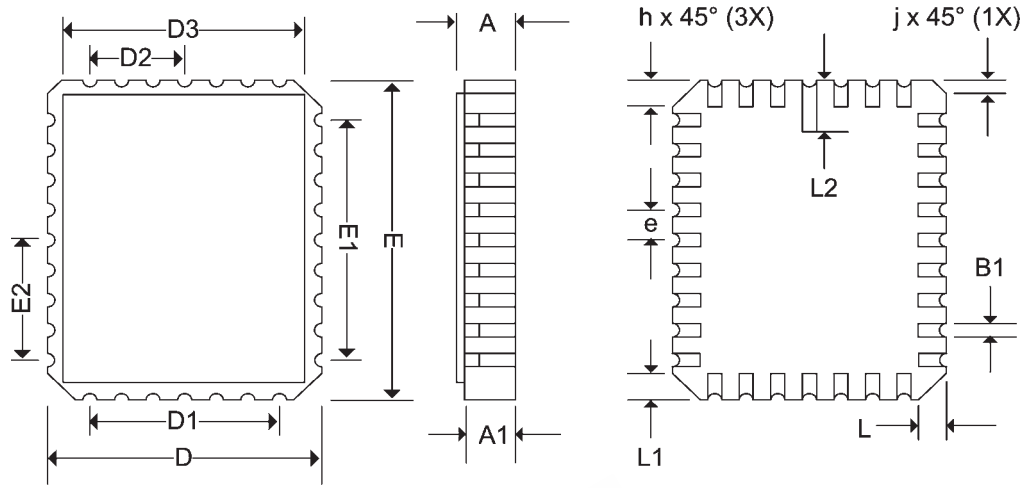

Pkg #	P5	
# Pins	28 (300 mil)	
Symbol	Min	Max
A	-	0.210
A1	-	-
b	0.014	0.023
b2	0.045	0.070
C	0.008	0.014
D	1.345	1.400
E1	0.270	0.300
E	0.300	0.380
e	0.100 BSC	
eB	-	0.430
L	0.115	0.150
$\alpha$	0°	15°

PLASTIC DUAL IN-LINE PACKAGE

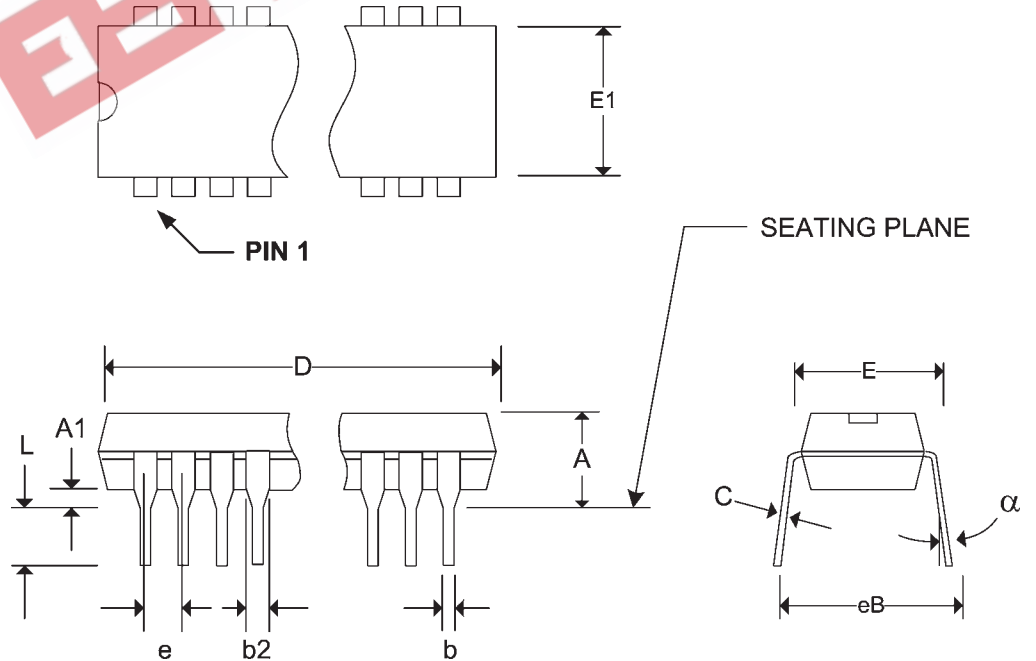

Pkg #	<b>T1</b>	
# Pins	28	
Symbol	<b>Min</b>	<b>Max</b>
A	0.039	0.047
A <sub>2</sub>	0.036	0.040
b	0.007	0.011
D	0.461	0.469
E	0.311	0.319
e	0.022 BSC	
H <sub>D</sub>	0.520	0.535

**TSOP THIN SMALL OUTLINE PACKAGE (8 x 13.4 mm)**



**NOTE:**  
Orientation ID is either next to Pin 1 (midway along row of pins) or in corner on side of package containing Pin 1.

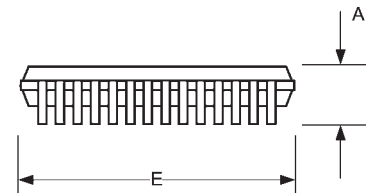

Pkg #	<b>S11-1</b>	
# Pins	28 (300 Mil)	
Symbol	<b>Min</b>	<b>Max</b>
A	0.093	0.104
A <sub>1</sub>	0.004	0.012
b <sub>2</sub>	0.013	0.020
C	0.009	0.012
D	0.696	0.712
e	0.050 BSC	
E	0.291	0.299
H	0.394	0.419
h	0.010	0.029
L	0.016	0.050
α	0°	8°

**SOIC/SOP SMALL OUTLINE IC PACKAGE**

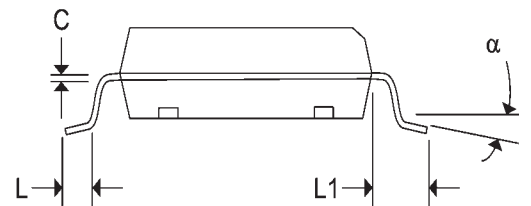

Pkg #	<b>S11-3</b>	
# Pins	28 (300 Mil)	
Symbol	<b>Min</b>	<b>Max</b>
A	0.094	0.110
A1	0.002	0.014
B	0.014	0.020
C	0.008	0.012
D	0.702	0.710
e	0.050 BSC	
E	0.291	0.300
H	0.463	0.477
h	0.010	0.029
L	0.020	0.042
$\alpha$	0°	8°

**SOIC/SOP SMALL OUTLINE IC PACKAGE**

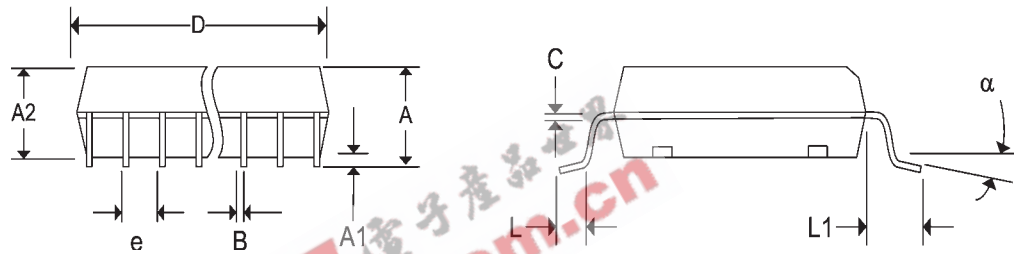



**REVISIONS**

<b>DOCUMENT NUMBER:</b>		SRAM119	
<b>DOCUMENT TITLE:</b>		HIGH SPEED 32K x 8 STATIC CMOS RAM	
REV.	ISSUE DATE	ORIG. OF CHANGE	DESCRIPTION OF CHANGE
OR	1997	RKK	New Data Sheet
A	Oct-05	JDB	Change logo to Pyramid
B	Oct-05	JDB	Added SOP Package
C	Apr-06	JDB	Added Lead-Free ordering information.
D	May-06	JDB	Added PDIP to Ordering Information diagram
E	Jun-06	JDB	Added Ceramic DIP package
F	Aug-06	JDB	Updated SOJ package information
G	Jun-07	JDB	Corrected SOP package information

