



# STK22C48

## 2K x 8 AutoStore™ nvSRAM QuantumTrap™ CMOS Nonvolatile Static RAM

### FEATURES

- 25ns, 35ns and 45ns Access Times
- “Hands-off” Automatic STORE with External 68μF Capacitor on Power Down
- STORE to Nonvolatile Elements Initiated by Hardware or AutoStore™ on Power Down
- Automatic RECALL on Power Up
- 10mA Typical I<sub>CC</sub> at 200ns Cycle Time
- Unlimited READ, WRITE and RECALL Cycles
- 1,000,000 STORE Cycles to Nonvolatile Elements
- 100-Year Data Retention in Nonvolatile Elements
- Single 5V ± 10% Operation
- Commercial and Industrial Temperatures
- 28-Pin DIP and SOIC Packages

### DESCRIPTION

The Simtek STK22C48 is a fast static RAM with a nonvolatile element incorporated in each static memory cell. The SRAM can be read and written an unlimited number of times, while independent, non-volatile data resides in Nonvolatile Elements. Data transfers from the SRAM to the Nonvolatile Elements (the STORE operation) can take place automatically on power down. A 68μF or larger capacitor tied from V<sub>CAP</sub> to ground guarantees the STORE operation, regardless of power-down slew rate or loss of power from “hot swapping”. Transfers from the Nonvolatile Elements to the SRAM (the RECALL operation) take place automatically on restoration of power. A hardware STORE may be initiated with the HSB pin.

### BLOCK DIAGRAM

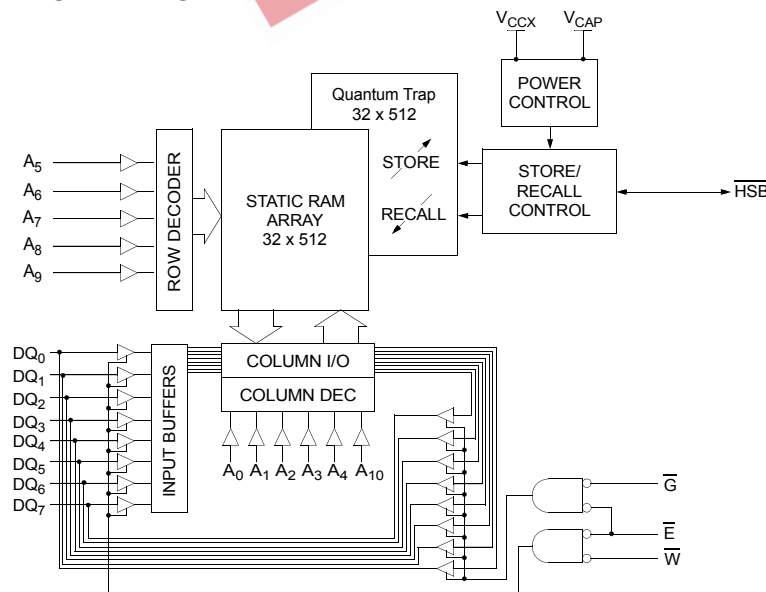

### PIN CONFIGURATIONS

V <sub>CAP</sub>	1	28	V <sub>CCX</sub>
NC	2	27	W
A <sub>7</sub>	3	26	HSB
A <sub>6</sub>	4	25	A <sub>8</sub>
A <sub>5</sub>	5	24	A <sub>9</sub>
A <sub>4</sub>	6	23	NC
A <sub>3</sub>	7	22	G
A <sub>2</sub>	8	21	A <sub>10</sub>
A <sub>1</sub>	9	20	E
A <sub>0</sub>	10	19	DQ <sub>7</sub>
DQ <sub>0</sub>	11	18	DQ <sub>6</sub>
DQ <sub>1</sub>	12	17	DQ <sub>5</sub>
DQ <sub>2</sub>	13	16	DQ <sub>4</sub>
V <sub>SS</sub>	14	15	DQ <sub>3</sub>

28 - 300 PDIP  
28 - 600 PDIP  
28 - 300 SOIC  
28 - 350 SOIC

### PIN NAMES

A <sub>0</sub> - A <sub>10</sub>	Address Inputs
DQ <sub>0</sub> - DQ <sub>7</sub>	Data In/Out
E	Chip Enable
W	Write Enable
G	Output Enable
HSB	Hardware Store Busy (I/O)
V <sub>CCX</sub>	Power (+ 5V)
V <sub>CAP</sub>	Capacitor
V <sub>SS</sub>	Ground

# STK22C48

## ABSOLUTE MAXIMUM RATINGS<sup>a</sup>

Voltage on Input Relative to Ground . . . . . -0.5V to 7.0V  
 Voltage on Input Relative to V<sub>SS</sub> . . . . . -0.6V to (V<sub>CC</sub> + 0.5V)  
 Voltage on DQ<sub>0-7</sub> or HSB . . . . . -0.5V to (V<sub>CC</sub> + 0.5V)  
 Temperature under Bias . . . . . -55°C to 125°C  
 Storage Temperature . . . . . -65°C to 150°C  
 Power Dissipation . . . . . 1W  
 DC Output Current (1 output at a time, 1s duration) . . . . . 15mA

Note a: Stresses greater than those listed under "Absolute Maximum Ratings" may cause permanent damage to the device. This is a stress rating only, and functional operation of the device at conditions above those indicated in the operational sections of this specification is not implied. Exposure to absolute maximum rating conditions for extended periods may affect reliability.

## DC CHARACTERISTICS

(V<sub>CC</sub> = 5.0V ± 10%)<sup>e</sup>

SYMBOL	PARAMETER	COMMERCIAL		INDUSTRIAL		UNITS	NOTES
		MIN	MAX	MIN	MAX		
I <sub>CC1</sub> <sup>b</sup>	Average V <sub>CC</sub> Current		85		90	mA	t <sub>AVAV</sub> = 25ns
			75		75	mA	t <sub>AVAV</sub> = 35ns
			65		65	mA	t <sub>AVAV</sub> = 45ns
I <sub>CC2</sub> <sup>c</sup>	Average V <sub>CC</sub> Current during STORE		3		3	mA	All Inputs Don't Care, V <sub>CC</sub> = max
I <sub>CC3</sub> <sup>b</sup>	Average V <sub>CC</sub> Current at t <sub>AVAV</sub> = 200ns 5V, 25°C, Typical		10		10	mA	$\bar{V} \geq (V_{CC} - 0.2V)$ All Others Cycling, CMOS Levels
I <sub>CC4</sub> <sup>c</sup>	Average V <sub>CAP</sub> Current during AutoStore™ Cycle		2		2	mA	All Inputs Don't Care
I <sub>SB1</sub> <sup>d</sup>	Average V <sub>CC</sub> Current (Standby, Cycling TTL Input Levels)		25		26	mA	t <sub>AVAV</sub> = 25ns, $\bar{E} \geq V_{IH}$
			21		22	mA	t <sub>AVAV</sub> = 35ns, $\bar{E} \geq V_{IH}$
			18		19	mA	t <sub>AVAV</sub> = 45ns, $\bar{E} \geq V_{IH}$
I <sub>SB2</sub> <sup>d</sup>	V <sub>CC</sub> Standby Current (Standby, Stable CMOS Input Levels)		1.5		1.5	mA	$\bar{E} \geq (V_{CC} - 0.2V)$ All Others V <sub>IN</sub> ≤ 0.2V or ≥ (V <sub>CC</sub> - 0.2V)
I <sub>ILK</sub>	Input Leakage Current		±1		±1	µA	V <sub>CC</sub> = max V <sub>IN</sub> = V <sub>SS</sub> to V <sub>CC</sub>
I <sub>OLK</sub>	Off-State Output Leakage Current		±5		±5	µA	V <sub>CC</sub> = max V <sub>IN</sub> = V <sub>SS</sub> to V <sub>CC</sub> , $\bar{E}$ or $\bar{G} \geq V_{IH}$
V <sub>IH</sub>	Input Logic "1" Voltage	2.2	V <sub>CC</sub> + .5	2.2	V <sub>CC</sub> + .5	V	All Inputs
V <sub>IL</sub>	Input Logic "0" Voltage	V <sub>SS</sub> - .5	0.8	V <sub>SS</sub> - .5	0.8	V	All Inputs
V <sub>OH</sub>	Output Logic "1" Voltage	2.4		2.4		V	I <sub>OUT</sub> = -4mA except HSB
V <sub>OL</sub>	Output Logic "0" Voltage		0.4		0.4	V	I <sub>OUT</sub> = 8mA except HSB
V <sub>BL</sub>	Logic "0" Voltage on HSB Output		0.4		0.4	V	I <sub>OUT</sub> = 3mA
T <sub>A</sub>	Operating Temperature	0	70	-40	85	°C	

Note b: I<sub>CC1</sub> and I<sub>CC3</sub> are dependent on output loading and cycle rate. The specified values are obtained with outputs unloaded.  
 Note c: I<sub>CC2</sub> and I<sub>CC4</sub> are the average currents required for the duration of the respective STORE cycles (t<sub>STORE</sub>).  
 Note d:  $\bar{E} \geq V_{IH}$  will not produce standby current levels until any nonvolatile cycle in progress has timed out.  
 Note e: V<sub>CC</sub> reference levels throughout this datasheet refer to V<sub>CCX</sub> if that is where the power supply connection is made, or V<sub>CAP</sub> if V<sub>CCX</sub> is connected to ground.

## AC TEST CONDITIONS

Input Pulse Levels . . . . . 0V to 3V  
 Input Rise and Fall Times . . . . . ≤ 5ns  
 Input and Output Timing Reference Levels . . . . . 1.5V  
 Output Load . . . . . See Figure 1

## CAPACITANCE<sup>f</sup> (T<sub>A</sub> = 25°C, f = 1.0MHz)

SYMBOL	PARAMETER	MAX	UNITS	CONDITIONS
C <sub>IN</sub>	Input Capacitance	8	pF	ΔV = 0 to 3V
C <sub>OUT</sub>	Output Capacitance	7	pF	ΔV = 0 to 3V

Note f: These parameters are guaranteed but not tested.



Figure 1: AC Output Loading

SRAM READ CYCLES #1 & #2

( $V_{CC} = 5.0V \pm 10\%$ )<sup>e</sup>

NO.	SYMBOLS		PARAMETER	STK22C48-25		STK22C48-35		STK22C48-45		UNITS
	#1, #2	Alt.		MIN	MAX	MIN	MAX	MIN	MAX	
1	$t_{ELQV}$	$t_{ACS}$	Chip Enable Access Time		25		35		45	ns
2	$t_{AVAV}$ <sup>g</sup>	$t_{RC}$	Read Cycle Time	25		35		45		ns
3	$t_{AVQV}$ <sup>h</sup>	$t_{AA}$	Address Access Time		25		35		45	ns
4	$t_{GLQV}$	$t_{OE}$	Output Enable to Data Valid		10		15		20	ns
5	$t_{AXQX}$ <sup>h</sup>	$t_{OH}$	Output Hold after Address Change	5		5		5		ns
6	$t_{ELQX}$	$t_{LZ}$	Chip Enable to Output Active	5		5		5		ns
7	$t_{EHQZ}$ <sup>i</sup>	$t_{HZ}$	Chip Disable to Output Inactive		10		13		15	ns
8	$t_{GLQX}$	$t_{OLZ}$	Output Enable to Output Active	0		0		0		ns
9	$t_{GHQZ}$ <sup>i</sup>	$t_{OHZ}$	Output Disable to Output Inactive		10		13		15	ns
10	$t_{ELICCH}$ <sup>f</sup>	$t_{PA}$	Chip Enable to Power Active	0		0		0		ns
11	$t_{EHICCL}$ <sup>f</sup>	$t_{PS}$	Chip Disable to Power Standby		25		35		45	ns

Note g:  $\bar{W}$  and  $\bar{HSB}$  must be high during SRAM READ cycles.  
 Note h: Device is continuously selected with  $\bar{E}$  and  $\bar{G}$  both low.  
 Note i: Measured  $\pm 200mV$  from steady state output voltage.

SRAM READ CYCLE #1: Address Controlled<sup>g, h</sup>

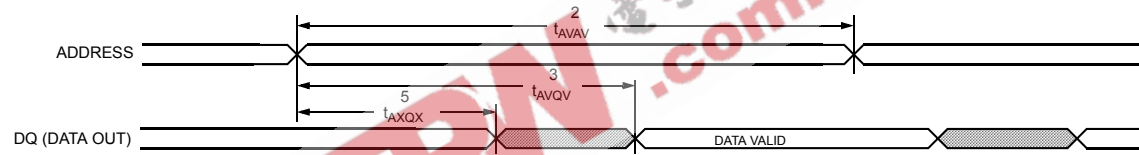

SRAM READ CYCLE #2:  $\bar{E}$  Controlled<sup>g</sup>

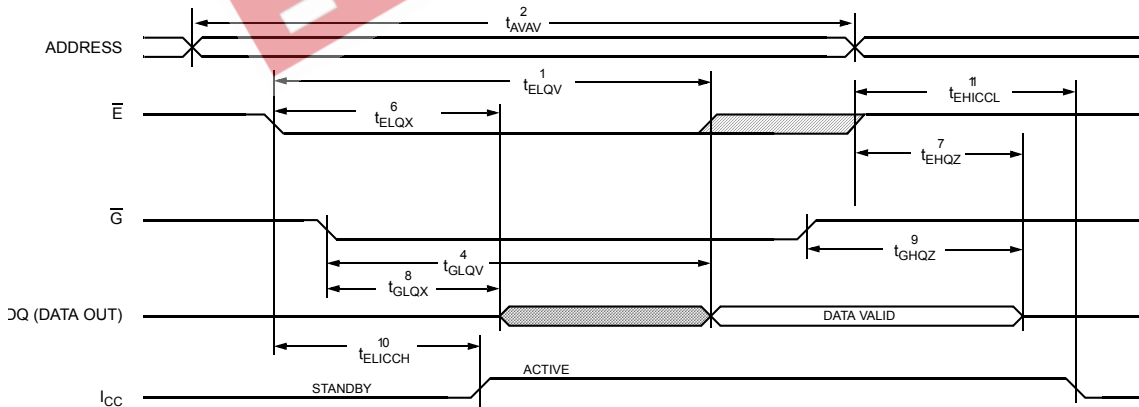

# STK22C48

## SRAM WRITE CYCLES #1 & #2

( $V_{CC} = 5.0V \pm 10\%$ )<sup>e</sup>

NO.	SYMBOLS			PARAMETER	STK22C48-25		STK22C48-35		STK22C48-45		UNITS
	#1	#2	Alt.		MIN	MAX	MIN	MAX	MIN	MAX	
12	$t_{AVAV}$	$t_{AVAV}$	$t_{WC}$	Write Cycle Time	25		35		45		ns
13	$t_{WLWH}$	$t_{WLEH}$	$t_{WP}$	Write Pulse Width	20		25		30		ns
14	$t_{ELWH}$	$t_{ELEH}$	$t_{CW}$	Chip Enable to End of Write	20		25		30		ns
15	$t_{DVWH}$	$t_{DVEH}$	$t_{DW}$	Data Set-up to End of Write	10		12		15		ns
16	$t_{WHDX}$	$t_{EHDX}$	$t_{DH}$	Data Hold after End of Write	0		0		0		ns
17	$t_{AVWH}$	$t_{AVEH}$	$t_{AW}$	Address Set-up to End of Write	20		25		30		ns
18	$t_{AVWL}$	$t_{AVEL}$	$t_{AS}$	Address Set-up to Start of Write	0		0		0		ns
19	$t_{WHAX}$	$t_{EHAX}$	$t_{WR}$	Address Hold after End of Write	0		0		0		ns
20	$t_{WLOZ}^{i,j}$		$t_{WZ}$	Write Enable to Output Disable		10		13		15	ns
21	$t_{WHQX}$		$t_{OW}$	Output Active after End of Write	5		5		5		ns

Note j: If  $\bar{W}$  is low when  $\bar{E}$  goes low, the outputs remain in the high-impedance state.

Note k:  $\bar{E}$  or  $\bar{W}$  must be  $\geq V_{IH}$  during address transitions.

Note l: HSB must be high during SRAM WRITE cycles.

### SRAM WRITE CYCLE #1: $\bar{W}$ Controlled<sup>k, l</sup>

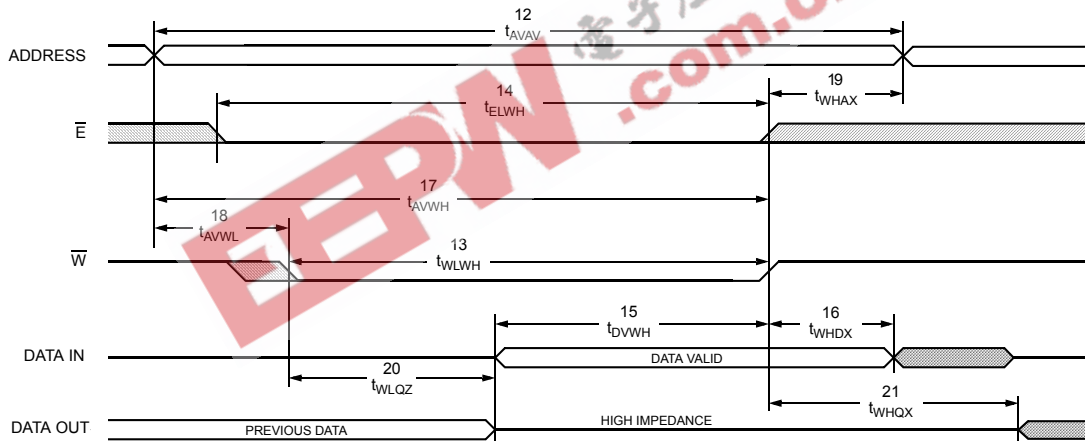

### SRAM WRITE CYCLE #2: $\bar{E}$ Controlled<sup>k, l</sup>

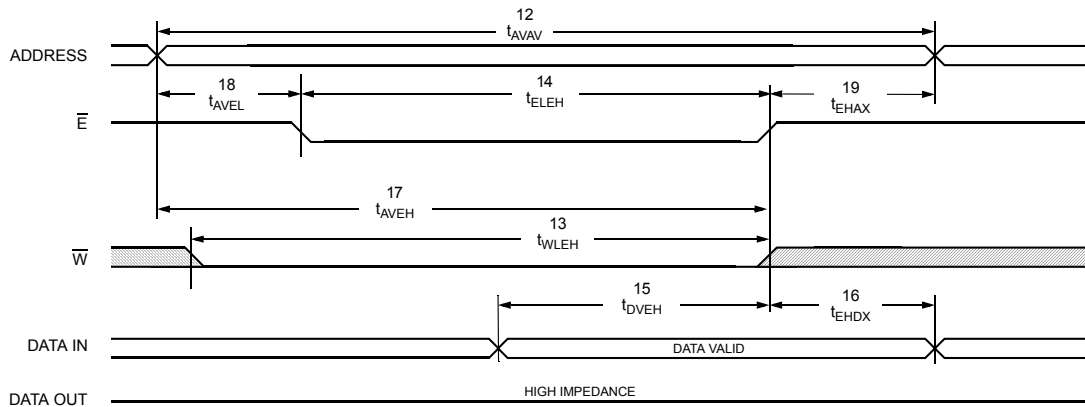

**HARDWARE MODE SELECTION**

$\overline{E}$	$\overline{W}$	$\overline{HSB}$	$A_{12} - A_0$ (hex)	MODE	I/O	POWER	NOTES
H	X	H	X	Not Selected	Output High Z	Standby	
L	H	H	X	Read SRAM	Output Data	Active	n
L	L	H	X	Write SRAM	Input Data	Active	
X	X	L	X	Nonvolatile STORE	Output High Z	$I_{CC2}$	m

Note m:  $\overline{HSB}$  STORE operation occurs only if an SRAM write has been done since the last nonvolatile cycle. After the STORE (if any) completes, the part will go into standby mode, inhibiting all operations until  $\overline{HSB}$  rises.

Note n: I/O state assumes  $\overline{G} \leq V_{IL}$ . Activation of nonvolatile cycles does not depend on state of  $\overline{G}$ .

**HARDWARE STORE CYCLE**

( $V_{CC} = 5.0V \pm 10\%$ )<sup>e</sup>

NO.	SYMBOLS		PARAMETER	STK22C48		UNITS	NOTES
	Standard	Alternate		MIN	MAX		
22	$t_{STORE}$	$t_{HLHZ}$	STORE Cycle Duration		10	ms	i, o
23	$t_{DELAY}$	$t_{HLQZ}$	Time Allowed to Complete SRAM Cycle	1		$\mu s$	i, p
24	$t_{RECOVER}$	$t_{HHQX}$	Hardware STORE High to Inhibit Off		700	ns	o, q
25	$t_{HLHX}$		Hardware STORE Pulse Width	15		ns	
26	$t_{HLBL}$		Hardware STORE Low to Store Busy		300	ns	

Note o:  $\overline{E}$  and  $\overline{G}$  low for output behavior.

Note p:  $\overline{E}$  and  $\overline{G}$  low and  $\overline{W}$  high for output behavior.

Note q:  $t_{RECOVER}$  is only applicable after  $t_{STORE}$  is complete.

**HARDWARE STORE CYCLE**

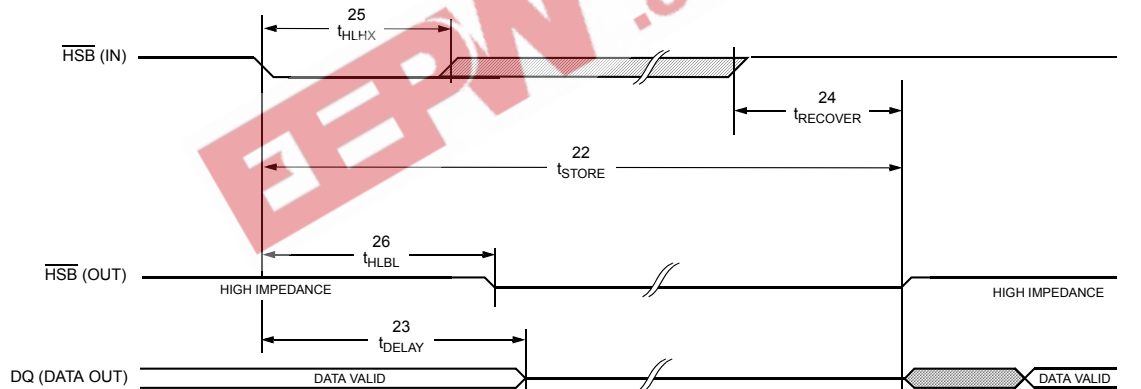

# STK22C48

## AutoStore™ / POWER-UP RECALL

( $V_{CC} = 5.0V \pm 10\%$ )<sup>e</sup>

NO.	SYMBOLS		PARAMETER	STK22C48		UNITS	NOTES
	Standard	Alternate		MIN	MAX		
27	$t_{RESTORE}$		Power-up <i>RECALL</i> Duration		550	$\mu s$	r
28	$t_{STORE}$	$t_{HLHZ}$	<i>STORE</i> Cycle Duration		10	ms	p, s
29	$t_{VSBL}$		Low Voltage Trigger ( $V_{SWITCH}$ ) to $\overline{HSB}$ Low		300	ns	l
30	$t_{DELAY}$	$t_{BLQZ}$	Time Allowed to Complete SRAM Cycle	1		$\mu s$	o
31	$V_{SWITCH}$		Low Voltage Trigger Level	4.0	4.5	V	
32	$V_{RESET}$		Low Voltage Reset Level		3.6	V	

Note r:  $t_{RESTORE}$  starts from the time  $V_{CC}$  rises above  $V_{SWITCH}$ .

Note s:  $\overline{HSB}$  is asserted low for  $1\mu s$  when  $V_{CAP}$  drops through  $V_{SWITCH}$ . If an SRAM write has not taken place since the last nonvolatile cycle,  $\overline{HSB}$  will be released and no *STORE* will take place.

## AutoStore™ / POWER-UP RECALL

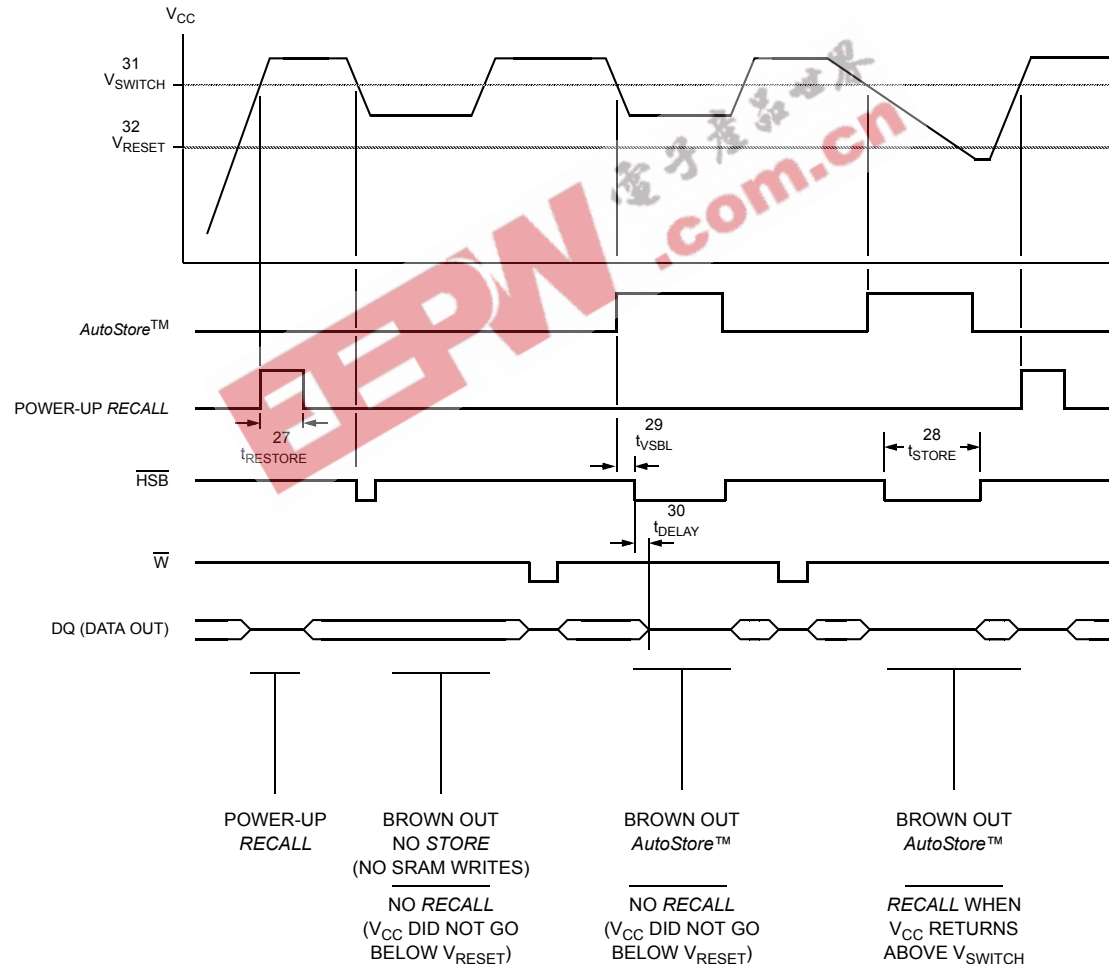

## DEVICE OPERATION

The STK22C48 has two separate modes of operation: SRAM mode and nonvolatile mode. In SRAM mode, the memory operates as a standard fast static RAM. In nonvolatile mode, data is transferred from SRAM to Nonvolatile Elements (the *STORE* operation) or from Nonvolatile Elements to SRAM (the *RECALL* operation). In this mode SRAM functions are disabled.

### NOISE CONSIDERATIONS

The STK22C48 is a high-speed memory and so must have a high-frequency bypass capacitor of approximately 0.1 $\mu$ F connected between  $V_{CAP}$  and  $V_{SS}$ , using leads and traces that are as short as possible. As with all high-speed CMOS ICs, normal careful routing of power, ground and signals will help prevent noise problems.

### SRAM READ

The STK22C48 performs a *READ* cycle whenever  $\bar{E}$  and  $\bar{G}$  are low and  $\bar{W}$  and  $HSB$  are high. The address specified on pins  $A_{0-10}$  determines which of the 2,048 data bytes will be accessed. When the *READ* is initiated by an address transition, the outputs will be valid after a delay of  $t_{AVQV}$  (*READ* cycle #1). If the *READ* is initiated by  $\bar{E}$  or  $\bar{G}$ , the outputs will be valid at  $t_{ELQV}$  or at  $t_{GLQV}$ , whichever is later (*READ* cycle #2). The data outputs will repeatedly respond to address changes within the  $t_{AVQV}$  access time without the need for transitions on any control input pins, and will remain valid until another address change or until  $\bar{E}$  or  $\bar{G}$  is brought high, or  $\bar{W}$  or  $HSB$  is brought low.

### SRAM WRITE

A *WRITE* cycle is performed whenever  $\bar{E}$  and  $\bar{W}$  are low and  $HSB$  is high. The address inputs must be stable prior to entering the *WRITE* cycle and must remain stable until either  $\bar{E}$  or  $\bar{W}$  goes high at the end of the cycle. The data on the common I/O pins  $DQ_{0-7}$  will be written into the memory if it is valid  $t_{DVWH}$  before the end of a  $\bar{W}$  controlled *WRITE* or  $t_{DVEH}$  before the end of an  $\bar{E}$  controlled *WRITE*.

It is recommended that  $\bar{G}$  be kept high during the entire *WRITE* cycle to avoid data bus contention on common I/O lines. If  $\bar{G}$  is left low, internal circuitry will turn off the output buffers  $t_{WLQZ}$  after  $\bar{W}$  goes low.

### POWER-UP RECALL

During power up, or after any low-power condition ( $V_{CAP} < V_{RESET}$ ), an internal *RECALL* request will be latched. When  $V_{CAP}$  once again exceeds the sense voltage of  $V_{SWITCH}$ , a *RECALL* cycle will automatically be initiated and will take  $t_{RESTORE}$  to complete.

If the STK22C48 is in a *WRITE* state at the end of power-up *RECALL*, the SRAM data will be corrupted. To help avoid this situation, a 10K Ohm resistor should be connected either between  $\bar{W}$  and system  $V_{CC}$  or between  $\bar{E}$  and system  $V_{CC}$ .

### AutoStore™ OPERATION

The STK22C48 can be powered in one of three modes.

During normal *AutoStore*™ operation, the STK22C48 will draw current from  $V_{CCX}$  to charge a capacitor connected to the  $V_{CAP}$  pin. This stored charge will be used by the chip to perform a single *STORE* operation. After power up, when the voltage on the  $V_{CAP}$  pin drops below  $V_{SWITCH}$ , the part will automatically disconnect the  $V_{CAP}$  pin from  $V_{CCX}$  and initiate a *STORE* operation.

Figure 2 shows the proper connection of capacitors for automatic store operation. A charge storage capacitor having a capacity of between 68 $\mu$ F and 220 $\mu$ F ( $\pm 20\%$ ) rated at 6V should be provided.

In system power mode (Figure 3), both  $V_{CCX}$  and  $V_{CAP}$  are connected to the +5V power supply without the 68 $\mu$ F capacitor. In this mode the *AutoStore*™ function of the STK22C48 will operate on the stored system charge as power goes down. The user must, however, guarantee that  $V_{CCX}$  does not drop below 3.6V during the 10ms *STORE* cycle.

If an automatic *STORE* on power loss is not required, then  $V_{CCX}$  can be tied to ground and +5V applied to  $V_{CAP}$  (Figure 4). This is the *AutoStore*™ Inhibit mode, in which the *AutoStore*™ function is disabled. If the STK22C48 is operated in this configuration, references to  $V_{CCX}$  should be changed to  $V_{CAP}$  throughout this data sheet. In this mode, *STORE* operations may be triggered with the  $HSB$  pin. It is not permissible to change between these three options "on the fly".

## STK22C48

In order to prevent unneeded *STORE* operations, automatic *STOREs* as well as those initiated by externally driving  $\overline{\text{HSB}}$  low will be ignored unless at least one *WRITE* operation has taken place since the most recent *STORE* or *RECALL* cycle. An optional pull-up resistor is shown connected to  $\overline{\text{HSB}}$ . This can be used to signal the system that the *AutoStore*<sup>™</sup> cycle is in progress.

### HSB OPERATION

The STK22C48 provides the  $\overline{\text{HSB}}$  pin for controlling and acknowledging the *STORE* operations. The  $\overline{\text{HSB}}$  pin is used to request a hardware *STORE* cycle. When the  $\overline{\text{HSB}}$  pin is driven low, the STK22C48 will conditionally initiate a *STORE* operation after  $t_{\text{DELAY}}$ ; an actual *STORE* cycle will only begin if a *WRITE* to the SRAM took place since the last *STORE* or *RECALL* cycle. The  $\overline{\text{HSB}}$  pin acts as an open drain driver that is internally driven low to indicate a busy condition while the *STORE* (initiated by any means) is in progress.

SRAM READ and *WRITE* operations that are in progress when  $\overline{\text{HSB}}$  is driven low by any means are given time to complete before the *STORE* operation is initiated. After  $\overline{\text{HSB}}$  goes low, the STK22C48 will continue SRAM operations for  $t_{\text{DELAY}}$ . During  $t_{\text{DELAY}}$ , multiple SRAM READ operations may take place. If a *WRITE* is in progress when  $\overline{\text{HSB}}$  is pulled low it will be allowed a time,  $t_{\text{DELAY}}$ , to complete. However, any SRAM *WRITE* cycles requested after  $\overline{\text{HSB}}$  goes low will be inhibited until  $\overline{\text{HSB}}$  returns high.

The  $\overline{\text{HSB}}$  pin can be used to synchronize multiple STK22C48s while using a single larger capacitor. To

operate in this mode the  $\overline{\text{HSB}}$  pin should be connected together to the  $\overline{\text{HSB}}$  pins from the other STK22C48s. An external pull-up resistor to +5V is required since  $\overline{\text{HSB}}$  acts as an open drain pull down. The  $V_{\text{CAP}}$  pins from the other STK22C48 parts can be tied together and share a single capacitor. The capacitor size must be scaled by the number of devices connected to it. When any one of the STK22C48s detects a power loss and asserts  $\overline{\text{HSB}}$ , the common  $\overline{\text{HSB}}$  pin will cause all parts to request a *STORE* cycle (a *STORE* will take place in those STK22C48s that have been written since the last nonvolatile cycle).

During any *STORE* operation, regardless of how it was initiated, the STK22C48 will continue to drive the  $\overline{\text{HSB}}$  pin low, releasing it only when the *STORE* is complete. Upon completion of the *STORE* operation the STK22C48 will remain disabled until the  $\overline{\text{HSB}}$  pin returns high.

If  $\overline{\text{HSB}}$  is not used, it should be left unconnected.

### PREVENTING STORES

The *STORE* function can be disabled on the fly by holding  $\overline{\text{HSB}}$  high with a driver capable of sourcing 30mA at a  $V_{\text{OH}}$  of at least 2.2V, as it will have to overpower the internal pull-down device that drives  $\overline{\text{HSB}}$  low for 20 $\mu\text{s}$  at the onset of a *STORE*. When the STK22C48 is connected for *AutoStore*<sup>™</sup> operation (system  $V_{\text{CC}}$  connected to  $V_{\text{CCX}}$  and a 68 $\mu\text{F}$  capacitor on  $V_{\text{CAP}}$ ) and  $V_{\text{CC}}$  crosses  $V_{\text{SWITCH}}$  on the way down, the STK22C48 will attempt to pull  $\overline{\text{HSB}}$  low; if  $\overline{\text{HSB}}$  doesn't actually get below  $V_{\text{IL}}$ , the part

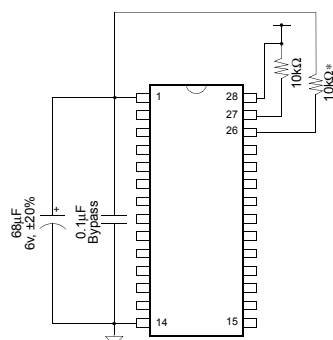

Figure 2: *AutoStore*<sup>™</sup> Mode

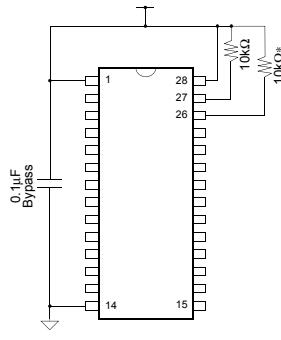

Figure 3: System Power Mode

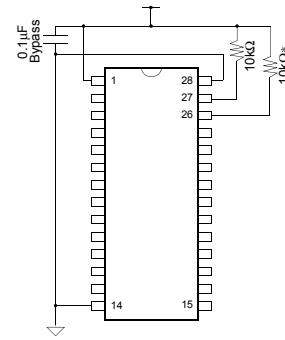

Figure 4: *AutoStore*<sup>™</sup> Inhibit Mode

\*If  $\overline{\text{HSB}}$  is not used, it should be left unconnected.



will stop trying to pull  $\overline{\text{HSB}}$  low and abort the *STORE* attempt.

**HARDWARE PROTECT**

The STK22C48 offers hardware protection against inadvertent *STORE* operation and SRAM WRITES during low-voltage conditions. When  $V_{\text{CAP}} < V_{\text{SWITCH}}$ , all externally initiated *STORE* operations and SRAM WRITES are inhibited.

*AutoStore*<sup>TM</sup> can be completely disabled by tying  $V_{\text{CCX}}$  to ground and applying +5V to  $V_{\text{CAP}}$ . This is the *AutoStore*<sup>TM</sup> Inhibit mode; in this mode *STORES* are only initiated by explicit request using the HSB pin.

**LOW AVERAGE ACTIVE POWER**

The STK22C48 draws significantly less current when it is cycled at times longer than 50ns. Figure 5 shows the relationship between  $I_{\text{CC}}$  and READ cycle time. Worst-case current consumption is shown for both CMOS and TTL input levels (commercial temperature range,  $V_{\text{CC}} = 5.5\text{V}$ , 100% duty cycle on chip enable). Figure 6 shows the same relationship for WRITE cycles. If the chip enable duty cycle is less than 100%, only standby current is drawn when the chip is disabled. The overall average current drawn by the STK22C48 depends on the following items: 1) CMOS vs. TTL input levels; 2) the duty cycle of chip enable; 3) the overall cycle rate for accesses; 4) the ratio of READs to WRITES; 5) the operating temperature; 6) the  $V_{\text{CC}}$  level; and 7) I/O loading.

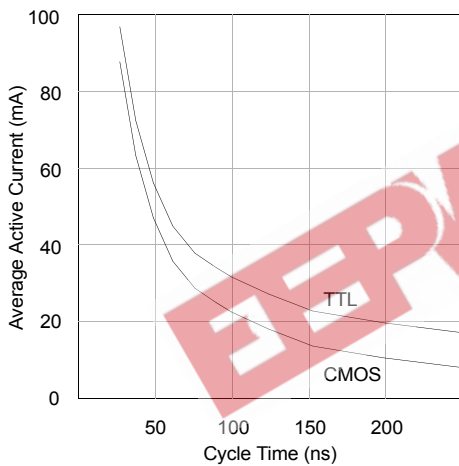

Figure 5:  $I_{\text{CC}}$  (max) Reads

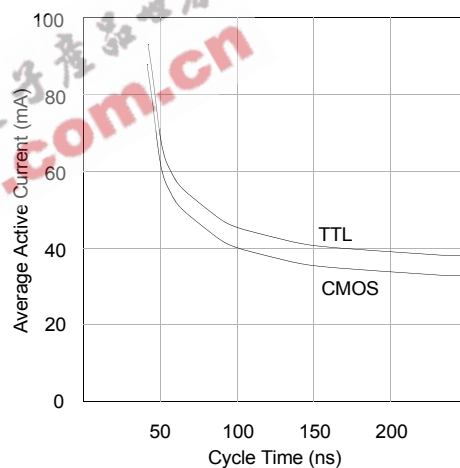
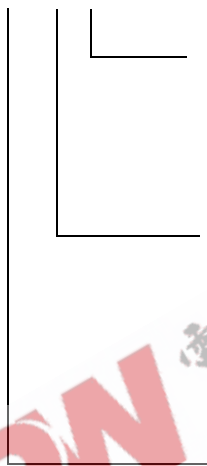

Figure 6:  $I_{\text{CC}}$  (max) Writes

**ORDERING INFORMATION**

**STK22C48 - P 45 I**



**Temperature Range**

Blank = Commercial (0 to 70°C)

I = Industrial (-40 to 85°C)

**Access Time**

25 = 25ns

35 = 35ns

45 = 45ns

**Package**

P = Plastic 28-pin 300 mil DIP

W = Plastic 28-pin 600 mil DIP

N = Plastic 28-pin 300 mil SOIC

S = Plastic 28-pin 350 mil SIOC

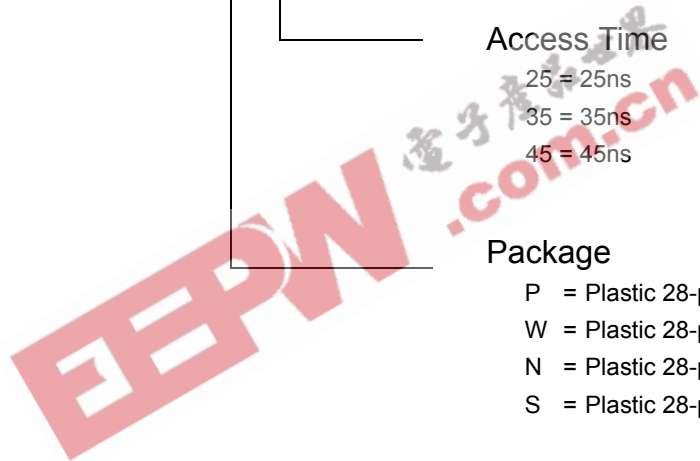

**STK22C48**

---

**Document Revision History**

Revision	Date	Summary
0.0	December 2002	Removed 20 nsec device.

