

SRAM

32K X 8 HIGH SPEED CMOS STATIC RAM

FEATURES

- High speed access time: 7/8/10/12/15ns(max.)
- Low power consumption : Active 300 mW (typ.)
- Single + 5 power supply
- Fully static operation – No clock or refreshing required
- All inputs and outputs directly TTL compatible
- Common I/O capability
- Available packages : 28-pin 300 mil SOJ and TSOP-I (forward type).
- Output enable (\overline{OE}) available for very fast access
- Mix-mode Outputs

PIN CONFIGURATION

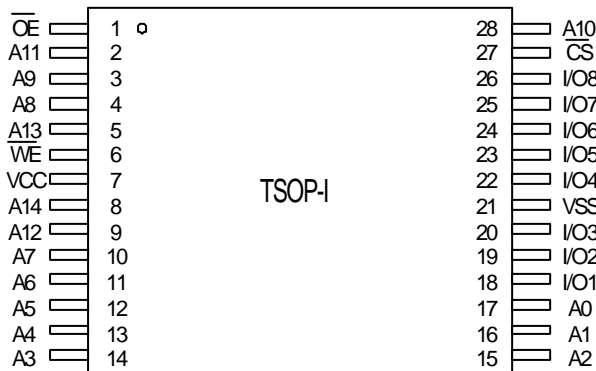
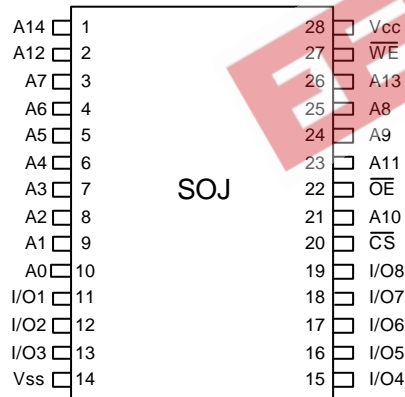

GENERAL DESCRIPTION

The T14M256A is a high speed, low power CMOS static RAM organized as 32,768 x 8 bits that operates on a single 5-volt power supply. This device is packaged in a standard 28-pin 300 mil SOJ or TSOP-I forward.

BLOCK DIAGRAM

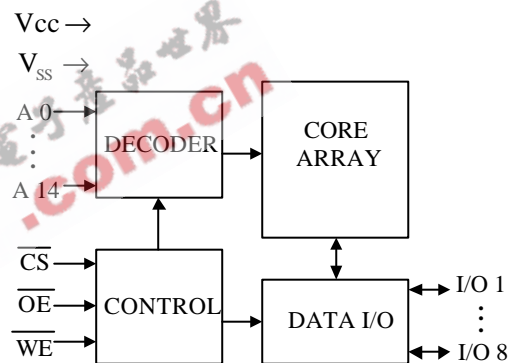

PIN DESCRIPTION

SYMBOL	DESCRIPTION
A0 - A14	Address Inputs
I/O1 - I/O8	Data Inputs/Outputs
\overline{CS}	Chip Select Inputs
\overline{WE}	Write Enable
\overline{OE}	Output Enable
Vcc	Power Supply
Vss	Ground

PART NUMBER EXAMPLES

	PACKAGE	SPEED
T14M256A-8J	SOJ	8ns
T14M256A-8P	TSOP-I	8ns

DC CHARACTERISTICS ABSOLUTE MAXIMUM RATINGS

PARAMETER	RATING	UNIT
Supply Voltage to Vss Potential	-0.5 to +6	V
Inputs to Vss Potential	-0.5 to Vcc +0.5	V
Power Dissipation	1.0	W
Storage Temperature	-60 to +150	°C

RECOMMENDED OPERATING CONDITIONS

PARAMETER	SYM	MIN	TYP	MAX	UNIT
Supply Voltage	Vcc	Typ-5%	5	Typ+5%	V
Input Voltage, low	V _{IL}	-0.3	-	0.8	V
Input Voltage, high	V _{IH}	2.2	-	Vcc+0.3	V
Ambient Temperature	T _A	0	-	70	°C

Note: V_{IL} (min.) = -2.0V for pulse width ≤ 20ns, V_{IH} (max.) = +7.0V for pulse width ≤ 20ns.

TRUTH TABLE

\overline{CS}	\overline{OE}	\overline{WE}	MODE	I/O1- I/O8	Vcc
H	X	X	Not Selected	High-Z	I _{SB} , I _{SBI}
L	H	H	Output Disable	High-Z	I _{cc}
L	L	H	Read	Data Out	I _{cc}
L	X	L	Write	Data In	I _{cc}

OPERATING CHARACTERISTICS

(Vcc = 5V±5%, Vss = 0V, Ta = 0 to 70°C)

PARAMETER	SYM.	TEST CONDITIONS	MIN.	TYP.	MAX.	UNIT	
Input Leakage Current	I _{LI}	Vin=Vss to Vcc	-10	-	+10	uA	
Output Leakage Current	I _{LO}	V _{I/O} =Vss to Vcc, $\overline{CS} = V_{IH}$ or $\overline{OE} = V_{IH}$ or $\overline{WE} = V_{IL}$	-10	-	+10	uA	
Output Low Voltage	V _{OL}	I _{OL} = + 8.0mA	-	-	0.4	V	
Output High Voltage	V _{OH}	I _{OH} = - 4.0mA	2.4	-	-	V	
Operating Power Supply Current	I _{cc}	$\overline{CS} = V_{IL}$, I/O=0mA Cycle = MIN. Duty = 100%	-7	-	-	125	mA
			-8	-	-	120	mA
			-10	-	-	110	mA
			-12	-	-	100	mA
Standby Power Supply Current	I _{SB}	$\overline{CS} = V_{IH}$, Cycle=MIN, Duty=100%	-	-	15	mA	
	I _{SBI}	$\overline{CS} \geq V_{CC}-0.2V$	-	-	2	mA	

Note: Typical characteristics are at Vcc = 5V, Ta = 25°C

CAPACITANCE

(V_{CC} = 5V, Ta = 25°C, f = 1 MHz)

PARAMETER	SYMBOL	CONDITION	MAX.	UNIT
Input Capacitance	C _{IN}	V _{IN} = 0V	6	pF
Input/ Output Capacitance	C _{I/O}	V _{OUT} = 0V	8	pF

Note: These parameters are sampled but not 100% tested.

AC TEST CONDITIONS

PARAMETER	CONDITIONS
Input Pulse Levels	0V to 3V
Input Rise and Fall Times	3 ns
Input and Output Timing Reference Level	1.5V
Output Load	C _L = 30pF, I _{OH} /I _{OL} = -4mA/8mA

AC TEST LOADS AND WAVEFORM

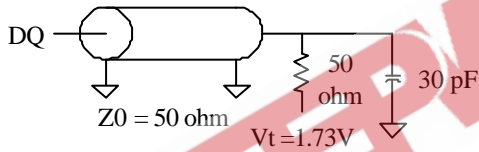

Fig.1

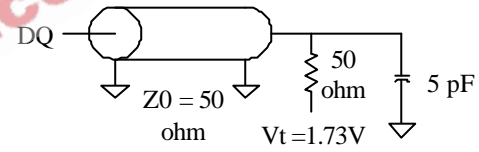

Fig.3

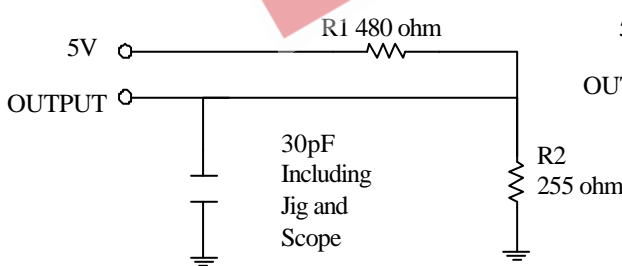

Fig.2

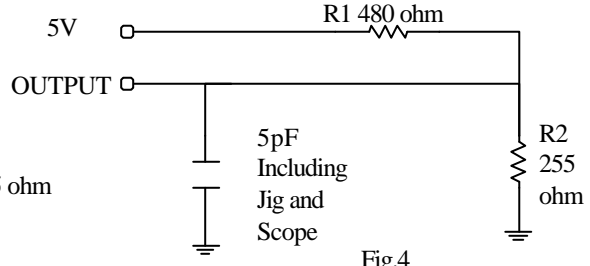

Fig.4

(For TCLZ, TOLZ, TCHZ, TOHZ, TWHZ, TOW)

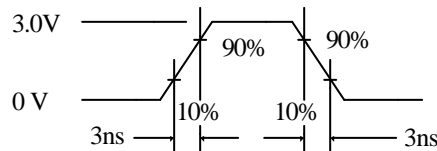

Fig.5

AC CHARACTERISTICS

(V_{CC} = 5V ± 5%, V_{SS} = 0V, Ta = 0 to 70°C)

(1) READ CYCLE

PARAMETER	SYM.	-7		-8		-10		-12		-15		UNIT
		MIN.	MAX.	MIN.	MAX.	MIN.	MAX.	MIN.	MAX.	MIN.	MAX.	
Read Cycle Time	t _{RC}	7	-	8	-	10	-	12	-	15	-	ns
Address Access Time	t _{AA}	-	7	-	8	-	10	-	12	-	15	ns
Chip Select Access Time	t _{ACS}	-	7	-	8	-	10	-	12	-	15	ns
Output Enable to Output Valid	t _{AOE}	-	3.5	-	5	-	6	-	7	-	7	ns
Chip Selection to Output in Low Z	t _{CLZ*}	2	-	3	-	3	-	3	-	3	-	ns
Output Enable to Output in Low Z	t _{OLZ}	0	-	0	-	0	-	0	-	0	-	ns
Chip Deselection to Output in High Z	t _{CHZ*}	-	3.5	-	4	-	5	-	6	0	7	ns
Output Disable to Output in High Z	t _{OHZ}	-	3.5	-	4	-	5	-	6	0	7	ns
Output Hold from Address Change	t _{OH}	2	-	2.5	-	3	-	3	-	3	-	ns

* These parameters are sampled but not 100% tested.

(2) WRITE CYCLE

PARAMETER	SYM.	-7		-8		-10		-12		-15		UNIT
		MIN.	MAX.	MIN.	MAX.	MIN.	MAX.	MIN.	MAX.	MIN.	MAX.	
Write Cycle Time	t _{WC}	7	-	8	-	10	-	12	-	15	-	ns
Chip Selection to End of Write	t _{CW}	5	-	6	-	8	-	10	-	11	-	ns
Address Valid to End of Write	t _{AW}	5	-	6	-	8	-	10	-	11	-	ns
Address Setup Time	t _{AS}	0	-	0	-	0	-	0	-	0	-	ns
Write Pulse Width	t _{WP}	5	-	6	-	8	-	10	-	11	-	ns
Write Recovery Time	t _{WR}	0	-	0	-	0	-	0	-	0	-	ns
Data Valid to End of Write	t _{DW}	3.5	-	5	-	6	-	8	-	8	-	ns
Data Hold from End of Write	t _{DH}	0	-	0	-	0	-	0	-	0	-	ns
Write to Output in High Z	t _{WHZ}	-	3	-	4	-	5	-	6	-	6	ns
Output Disable to Output in High Z	t _{OHZ}	-	3.5	-	4	-	5	-	6	-	7	ns
Output Active from End of Write	t _{OW}	0	-	0	-	0	-	0	-	0	-	ns

* These parameters are sampled but not 100% tested.

TIMING WAVEFORMS

READ CYCLE 1

(Address Controlled)

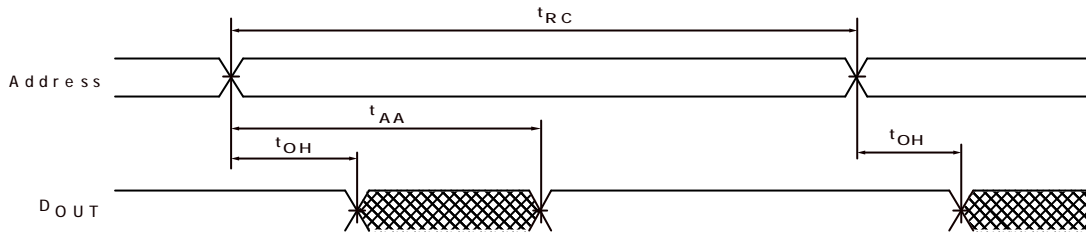

READ CYCLE 2

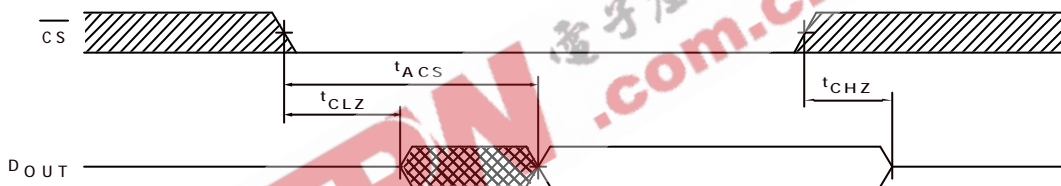

(Chip Select Controlled)

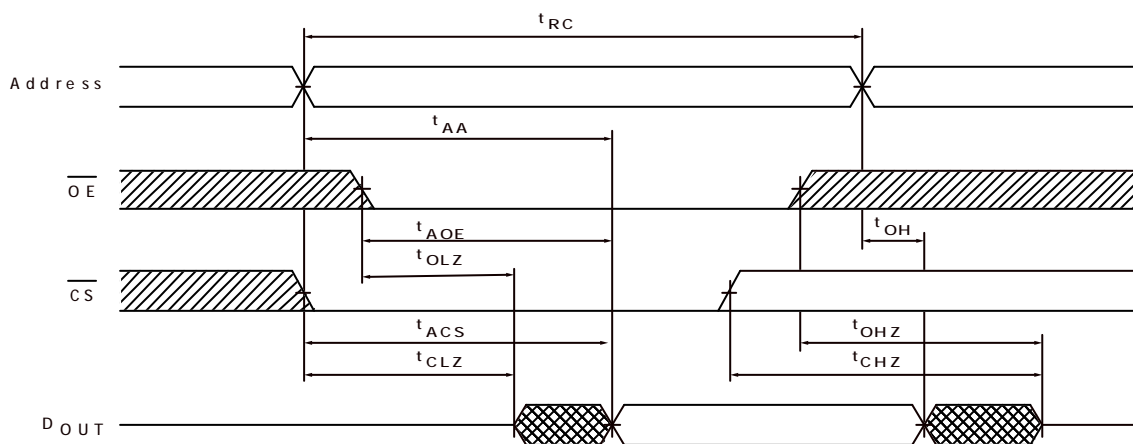

READ CYCLE 3

(Output Enable Controlled)



 DON'T CARE
 UNDEFINED

WRITE CYCLE 1 (\overline{OE} CLOCK)

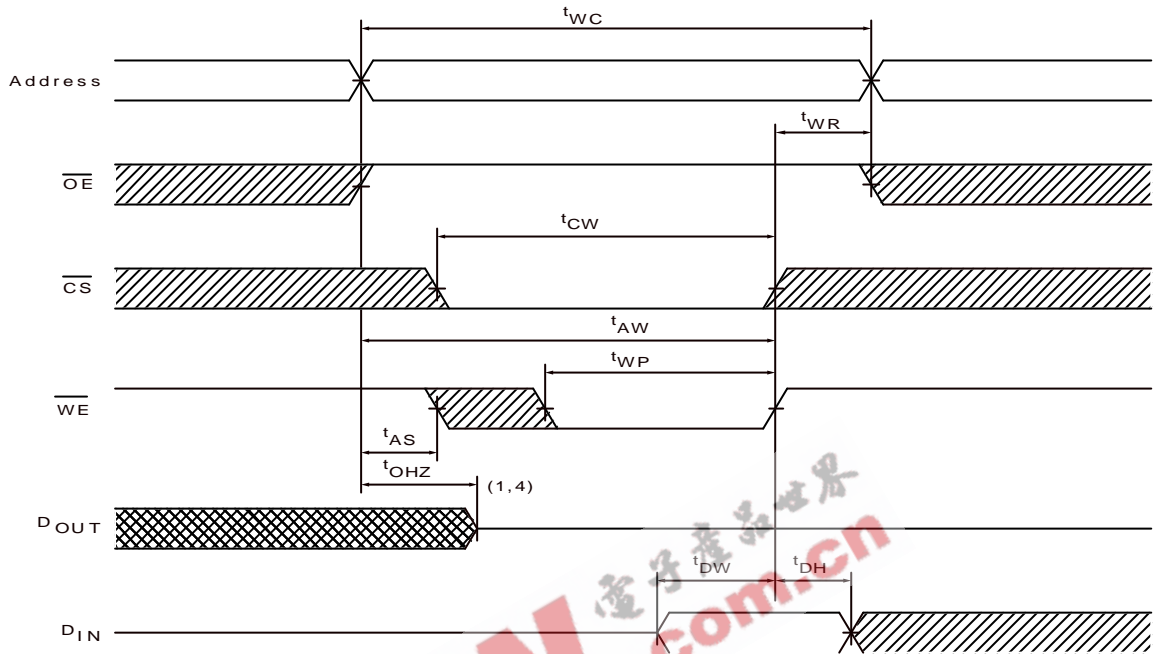

WRITE CYCLE 2 ($\overline{OE} = V_{IL}$ Fixed)

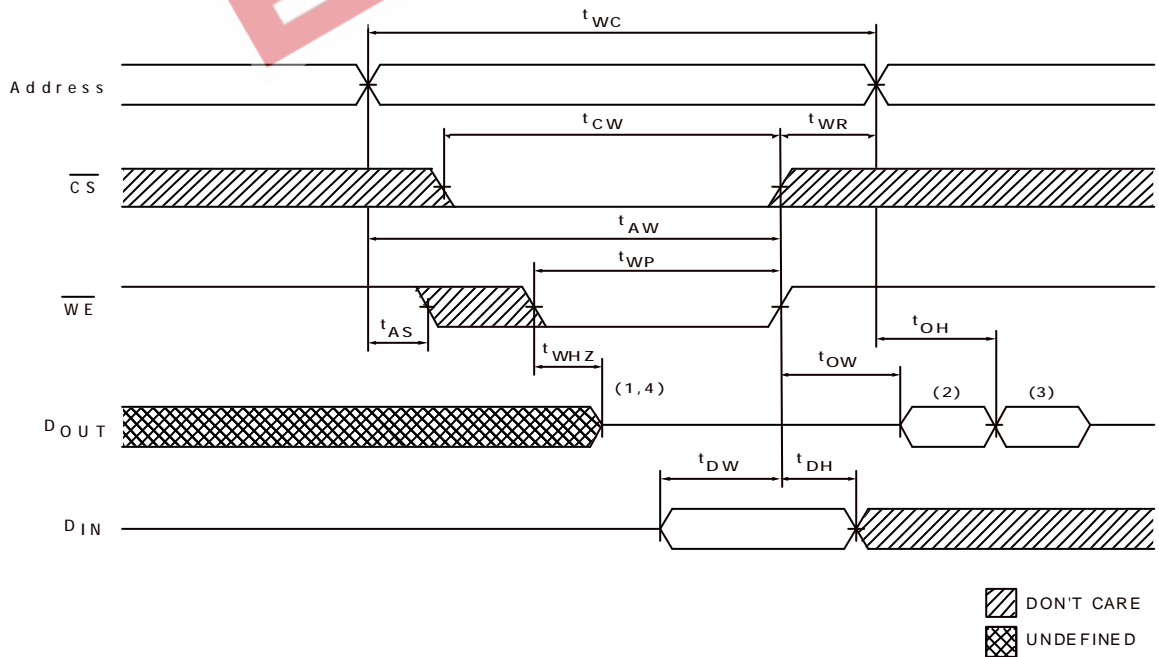

- Notes:
1. During this period, I/O pins are in the output state, so input signals of opposite phase to the outputs should not be applied.
 2. The data output from D_{OUT} are the same as the data written to D_{IN} during the write cycle.
 3. D_{OUT} provides the read data for the next address.
 4. Transition is measured ± 500 mV from steady state with $C_L = 5$ pF. This parameter is guaranteed but not 100% tested.
 5. If \overline{OE} is low during a \overline{WE} controlled write cycle, the write pulse width must be the larger of t_{WP} or $(t_{WHZ} + t_{DW})$ to allow the I/O drivers to turn off and data to be placed on the bus for the required t_{DW} . If \overline{OE} is high during a \overline{WE} controlled write cycle, this requirement does not apply and the write pulse can be as short as the specified t_{WP} .

EEPW 电子產品世界
.com.cn

PACKAGE DIMENSIONS
28-LEAD SOJ SRAM (300 mil)

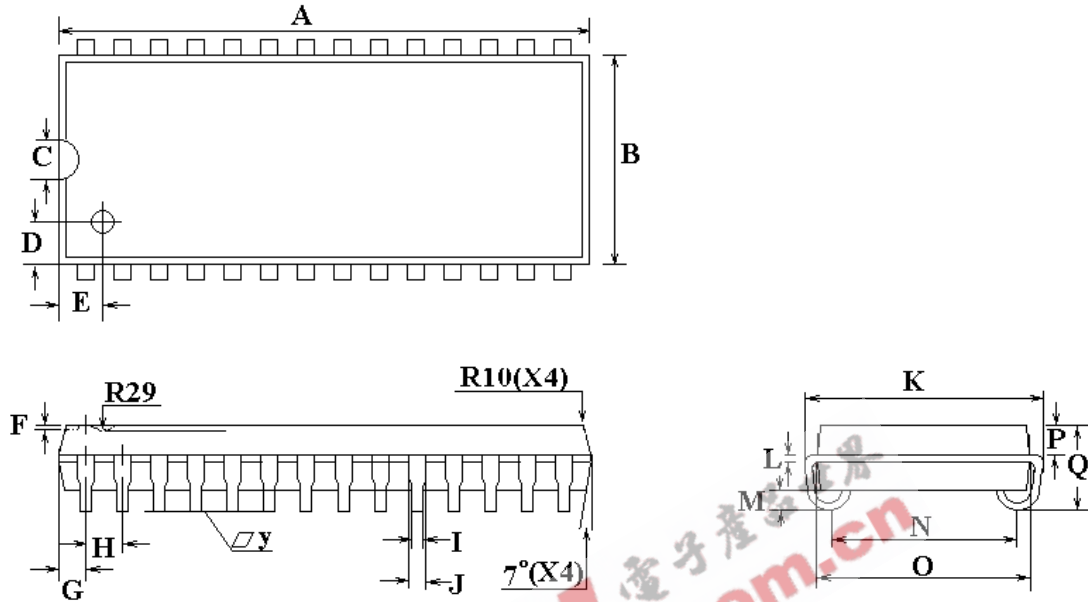

SYMBOL	DIMENSIONS IN INCHES	DIMENSIONS IN MM
A	0.710±0.002	18.03±0.05
B	0.300±0.005	7.62±0.13
C	0.060±0.002	1.52±0.05
D	0.050±0.001	1.27±0.03
E	0.063±0.001	1.63±0.03
F	0.015±0.002	0.38±0.05
G	0.030±0.002	0.76±0.05
H	0.050±0.002	1.27±0.05
I	0.018±0.002	0.46±0.05
J	0.028±0.002	0.71±0.05
K	0.337±0.002	8.56±0.05
L	0.010±0.001	0.25±0.03
M	0.026±0.002	0.66±0.05
N	0.268±0.003	6.81±0.08
O	0.300±0.002	7.62±0.05
P	0.053±0.001	1.35±0.03
Q	0.140±0.004	3.56±0.10
y	0.004(MAX)	0.10(MAX)

PACKAGE DIMENSIONS
28-LEAD TSOP-I SRAM (8X13.4mm)

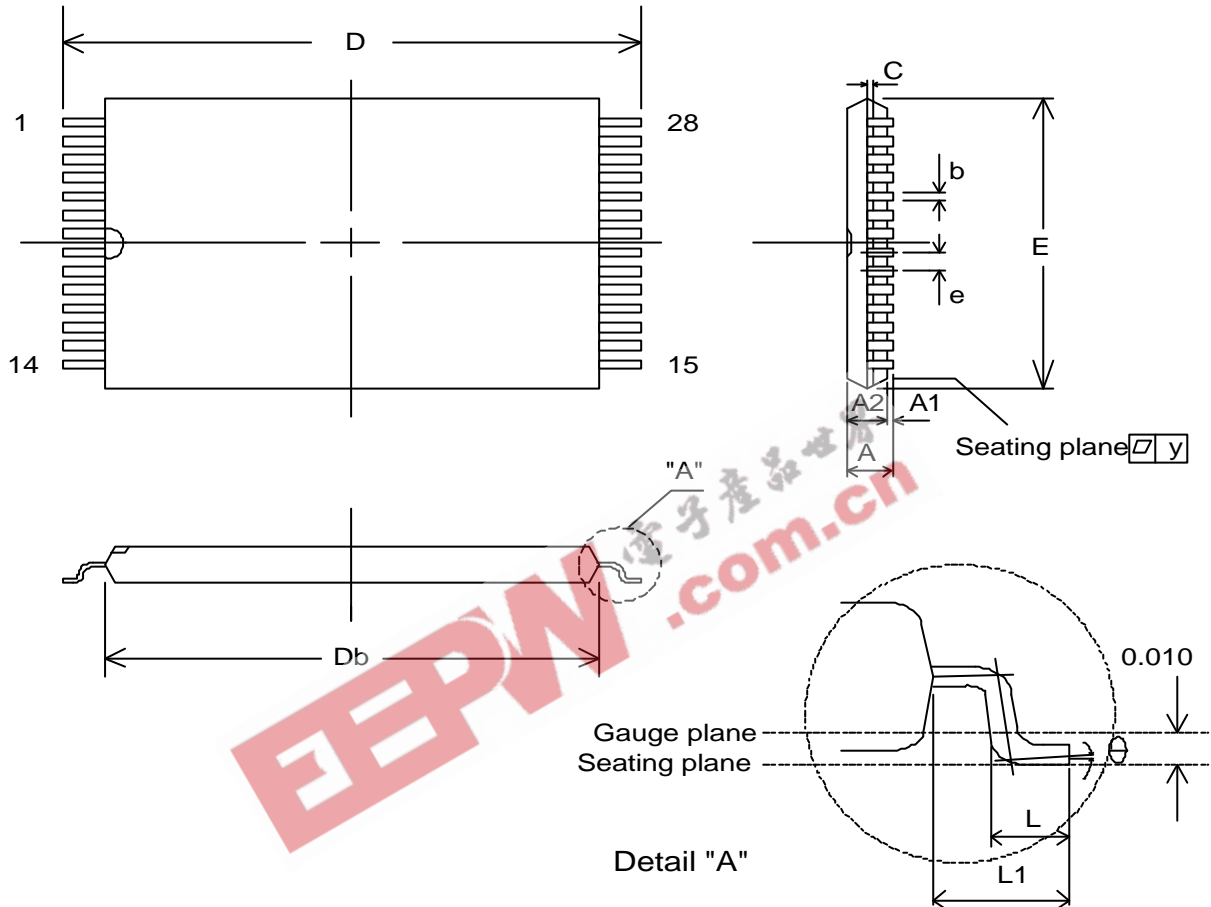

SYMBOL	DIMENSIONS IN INCHES	DIMENSIONS IN MM
A	0.047(max.)	1.20(max.)
A1	0.004±0.002	0.10±0.05
A2	0.039±0.002	1.00±0.05
b	0.008(typ.)	0.20(typ.)
c	0.006(typ.)	0.15(typ.)
Db	0.465±0.004	11.80±0.10
E	0.315±0.004	8.00±0.10
e	0.022(typ.)	0.55(typ.)
D	0.528±0.008	13.40±0.20
L	0.020±0.004	0.50±0.10
L1	0.0315±0.004	0.80±0.10
y	0.004(max.)	0.10(max.)
θ	0°~5°	0°~5°