



# STK1744

## nvTime™

### 32K x 8 AutoStore™ nvSRAM

#### with Real-Time Clock

### FEATURES

- Data Integrity of Simtek nvSRAM Combined with Full-Featured Real-Time Clock
- Stand-Alone Nonvolatile Memory and Time-Keeping Solution—No Other Parts Required
- No Batteries to Fail
- Fast 25ns, 35ns and 45ns Access Times
- Software- and AutoStore™-Controlled Nonvolatile Cycles
- Year 2000 Compliant with Leap Year Compensation
- 24-Hour BCD Format
- 100-Year Data Retention over Full Industrial Temperature Range
- Full 30-Day RTC Operation on Each Power Loss
- Single 5V ± 10% Power Supply

### DESCRIPTION

PRELIMINARY

The Simtek STK1744 DIP module houses 256Kb of nonvolatile static RAM, a real-time clock (RTC) with crystal and a high-value capacitor to support systems that require high reliability and ease of manufacturing. READ and WRITE access to all RTC functions and the memory is the same as a conventional x 8 SRAM. The highest eight addresses of the RAM support clock registers for centuries, years, months, dates, days, hours, minutes and seconds.

Independent data resides in the integral Nonvolatile Elements at all times. Automatic *RECALL* on power up transfers the Nonvolatile Elements data to the SRAM, while an automatic *STORE* on power down transfers SRAM data to the Nonvolatile Elements. A software *RECALL* and *STORE* are also possible on user command. *nvTime™* allows unlimited READ and WRITE accesses to SRAM, unlimited *RECALLS* and 10<sup>6</sup> *STORES*.

### BLOCK DIAGRAM

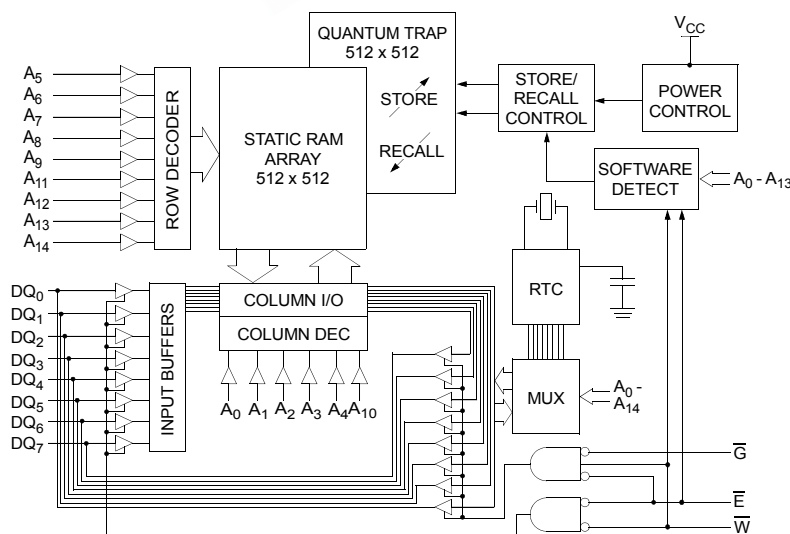

### PIN CONFIGURATIONS

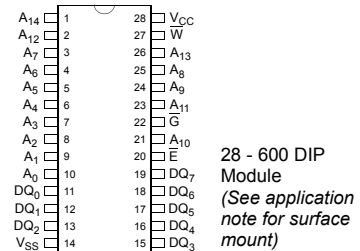

### PIN NAMES

Pin Name	Description
A <sub>0</sub> - A <sub>14</sub>	Address Inputs
$\bar{W}$	Write Enable
DQ <sub>0</sub> - DQ <sub>7</sub>	Data In/Out
$\bar{E}$	Chip Enable
$\bar{G}$	Output Enable
V <sub>CC</sub>	Power (+ 5V)
V <sub>SS</sub>	Ground

# STK1744

## ABSOLUTE MAXIMUM RATINGS<sup>a</sup>

Voltage on Input Relative to Ground	−0.5V to 7.0V
Voltage on Input Relative to V <sub>SS</sub>	−0.6V to (V <sub>CC</sub> + 0.5V)
Voltage on DQ <sub>0-7</sub>	−0.5V to (V <sub>CC</sub> + 0.5V)
Temperature under Bias	−55°C to 85°C
Storage Temperature	−65°C to 85°C
Power Dissipation	1W
DC Output Current (1 output at a time, 1s duration)	15mA

Note a: Stresses greater than those listed under “Absolute Maximum Ratings” may cause permanent damage to the device. This is a stress rating only, and functional operation of the device at conditions above those indicated in the operational sections of this specification is not implied. Exposure to absolute maximum rating conditions for extended periods may affect reliability.

## DC CHARACTERISTICS

(V<sub>CC</sub> = 5.0V ± 10%)

SYMBOL	PARAMETER	COMMERCIAL		INDUSTRIAL		UNITS	NOTES
		MIN	MAX	MIN	MAX		
I <sub>CC1</sub> <sup>b</sup>	Average V <sub>CC</sub> Current		97 80 70		100 85 70	mA	t <sub>AVAV</sub> = 25ns t <sub>AVAV</sub> = 35ns t <sub>AVAV</sub> = 45ns
I <sub>CC2</sub>	Average V <sub>CC</sub> Current during STORE		3		3	mA	All Inputs Don't Care, V <sub>CC</sub> = max
I <sub>CC3</sub> <sup>b</sup>	Average V <sub>CC</sub> Current at t <sub>AVAV</sub> = 200ns 5V, 25°C, Typical		10		10	mA	$\bar{V} \geq (V_{CC} - 0.2V)$ All Others Cycling, CMOS Levels
I <sub>SB1</sub> <sup>c</sup>	Average V <sub>CC</sub> Current (Standby, Cycling TTL Input Levels)		30 25 22		31 26 23	mA	t <sub>AVAV</sub> = 25ns, $\bar{E} \geq V_{IH}$ t <sub>AVAV</sub> = 35ns, $\bar{E} \geq V_{IH}$ t <sub>AVAV</sub> = 45ns, $\bar{E} \geq V_{IH}$
I <sub>SB2</sub> <sup>c</sup>	V <sub>CC</sub> Standby Current (Standby, Stable CMOS Input Levels)		1.5		1.5	mA	$\bar{E} \geq (V_{CC} - 0.2V)$ All Others V <sub>IN</sub> ≤ 0.2V or ≥ (V <sub>CC</sub> - 0.2V)
I <sub>ILK</sub>	Input Leakage Current		±1		±1	µA	V <sub>CC</sub> = max V <sub>IN</sub> = V <sub>SS</sub> to V <sub>CC</sub>
I <sub>OLK</sub>	Off-State Output Leakage Current		±5		±5	µA	V <sub>CC</sub> = max V <sub>IN</sub> = V <sub>SS</sub> to V <sub>CC</sub> , $\bar{E}$ or $\bar{G} \geq V_{IH}$
V <sub>IH</sub>	Input Logic “1” Voltage	2.2	V <sub>CC</sub> + .5	2.2	V <sub>CC</sub> + .5	V	All Inputs
V <sub>IL</sub>	Input Logic “0” Voltage	V <sub>SS</sub> - .5	0.8	V <sub>SS</sub> - .5	0.8	V	All Inputs
V <sub>OH</sub>	Output Logic “1” Voltage	2.4		2.4		V	I <sub>OUT</sub> = −4mA
V <sub>OL</sub>	Output Logic “0” Voltage		0.4		0.4	V	I <sub>OUT</sub> = 8mA
T <sub>A</sub>	Operating Temperature	0	70	−40	85	°C	

Note b: I<sub>CC1</sub> and I<sub>CC3</sub> are dependent on output loading and cycle rate. The specified values are obtained at minimum cycle with outputs unloaded.  
 Note c:  $\bar{E} \geq V_{IH}$  will not produce standby current levels until any nonvolatile cycle in progress has timed out.

## AC TEST CONDITIONS

Input Pulse Levels	0V to 3V
Input Rise and Fall Times	≤ 5ns
Input and Output Timing Reference Levels	1.5V
Output Load	See Figure 1

## CAPACITANCE<sup>d</sup> (T<sub>A</sub> = 25°C, f = 1.0MHz)

SYMBOL	PARAMETER	MAX	UNITS	CONDITIONS
C <sub>IN</sub>	Input Capacitance	10	pF	ΔV = 0 to 3V
C <sub>OUT</sub>	Output Capacitance	12	pF	ΔV = 0 to 3V

Note d: These parameters are guaranteed but not tested.

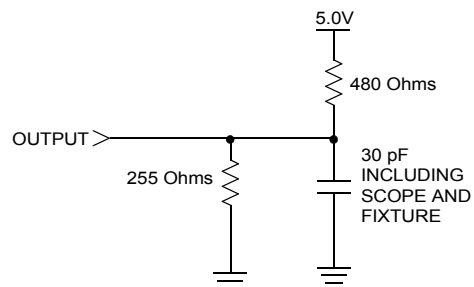

Figure 1: AC Output Loading

READ CYCLES #1 & #2

( $V_{CC} = 5.0V \pm 10\%$ )

NO.	SYMBOLS		PARAMETER	STK1744-25		STK1744-35		STK1744-45		UNITS
	#1, #2	Alt.		MIN	MAX	MIN	MAX	MIN	MAX	
1	$t_{ELQV}$	$t_{ACS}$	Chip Enable Access Time		25		35		45	ns
2	$t_{AVAV}^e$	$t_{RC}$	Read Cycle Time	25		35		45		ns
3	$t_{AVQV}^f$	$t_{AA}$	Address Access Time		25		35		45	ns
4	$t_{GLQV}$	$t_{OE}$	Output Enable to Data Valid		10		15		20	ns
5	$t_{AXQX}^f$	$t_{OH}$	Output Hold after Address Change	5		5		5		ns
6	$t_{ELQX}$	$t_{LZ}$	Chip Enable to Output Active	5		5		5		ns
7	$t_{EHQZ}^g$	$t_{HZ}$	Chip Disable to Output Inactive		10		13		15	ns
8	$t_{GLQX}$	$t_{OLZ}$	Output Enable to Output Active	0		0		0		ns
9	$t_{GHQZ}^g$	$t_{OHZ}$	Output Disable to Output Inactive		10		13		15	ns
10	$t_{ELICCH}^d$	$t_{PA}$	Chip Enable to Power Active	0		0		0		ns
11	$t_{EHICCL}^{c,d}$	$t_{PS}$	Chip Disable to Power Standby		25		35		45	ns

Note e:  $\bar{W}$  must be high during SRAM READ cycles and low during SRAM WRITE cycles.

Note f: I/O state assumes  $E, \bar{G} \leq V_{IL}$  and  $\bar{W} \geq V_{IH}$ ; device is continuously selected.

Note g: Measured  $\pm 200mV$  from steady state output voltage.

READ CYCLE #1: Address Controlled<sup>e, f</sup>

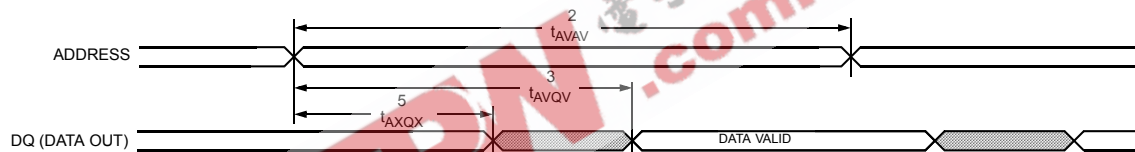

READ CYCLE #2:  $\bar{E}$  Controlled<sup>e</sup>

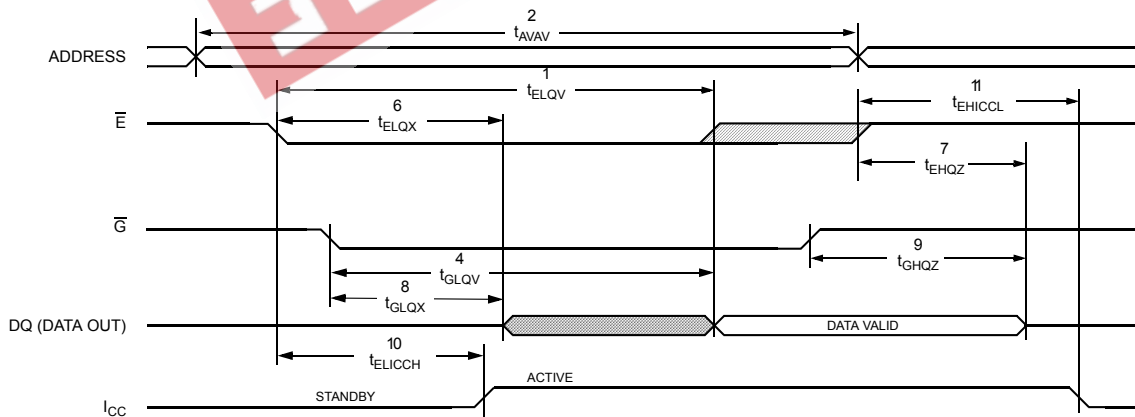

# STK1744

## WRITE CYCLES #1 & #2

( $V_{CC} = 5.0V \pm 10\%$ )

NO.	SYMBOLS			PARAMETER	STK1744-25		STK1744-35		STK1744-45		UNITS
	#1	#2	Alt.		MIN	MAX	MIN	MAX	MIN	MAX	
12	$t_{AVAV}$	$t_{AVAV}$	$t_{WC}$	Write Cycle Time	25		35		45		ns
13	$t_{WLWH}$	$t_{WLEH}$	$t_{WP}$	Write Pulse Width	20		25		30		ns
14	$t_{ELWH}$	$t_{ELEH}$	$t_{CW}$	Chip Enable to End of Write	20		25		30		ns
15	$t_{DVWH}$	$t_{DVEH}$	$t_{DW}$	Data Set-up to End of Write	10		12		15		ns
16	$t_{WHDX}$	$t_{EHDX}$	$t_{DH}$	Data Hold after End of Write	0		0		0		ns
17	$t_{AVWH}$	$t_{AVEH}$	$t_{AW}$	Address Set-up to End of Write	20		25		30		ns
18	$t_{AVWL}$	$t_{AVEL}$	$t_{AS}$	Address Set-up to Start of Write	0		0		0		ns
19	$t_{WHAX}$	$t_{EHAX}$	$t_{WR}$	Address Hold after End of Write	0		0		0		ns
20	$t_{WLOZ}^{g,h}$		$t_{WZ}$	Write Enable to Output Disable		10		13		15	ns
21	$t_{WHQX}$		$t_{OW}$	Output Active after End of Write	5		5		5		ns

Note h: If  $\bar{W}$  is low when  $\bar{E}$  goes low, the outputs remain in the high-impedance state.

Note i:  $\bar{E}$  or  $\bar{W}$  must be  $\geq V_{IH}$  during address transitions.

### WRITE CYCLE #1: $\bar{W}$ Controlled<sup>i</sup>

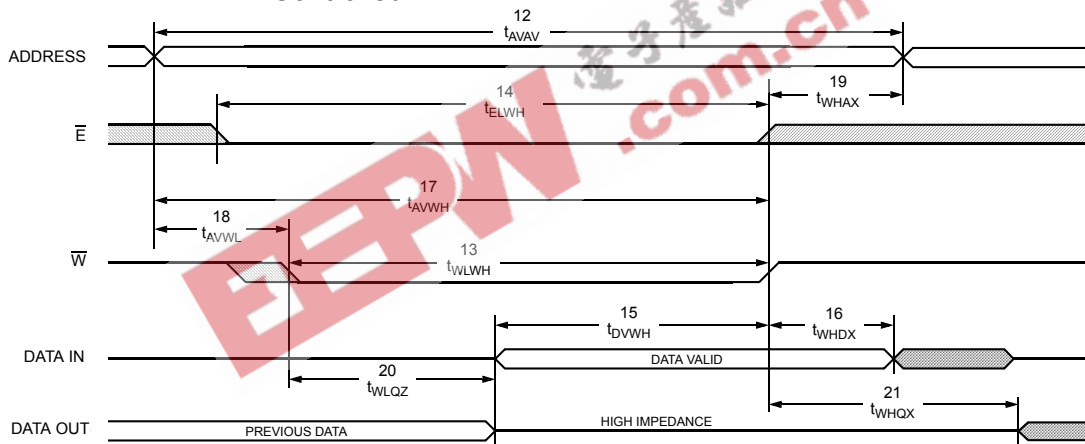

### WRITE CYCLE #2: $\bar{E}$ Controlled<sup>i</sup>

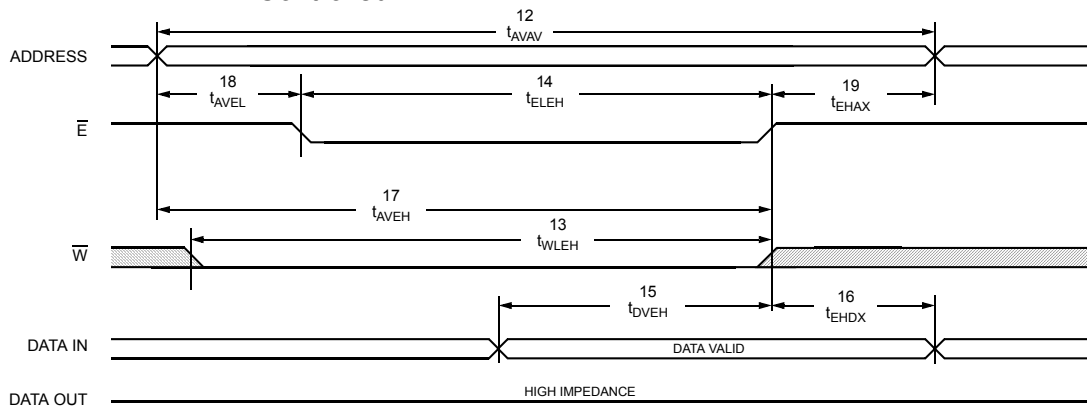

**AutoStore™/POWER-UP RECALL**

( $V_{CC} = 5.0V \pm 10\%$ )

NO.	SYMBOLS	PARAMETER	STK1744		UNITS	NOTES
	Standard		MIN	MAX		
22	$t_{RESTORE}$	Power-up <i>RECALL</i> Duration		550	$\mu$ s	j
23	$t_{STORE}$	<i>STORE</i> Cycle Duration		10	ms	f
24	$V_{SWITCH}$	Low Voltage Trigger Level	4.0	4.5	V	
25	$V_{RESET}$	Low Voltage Reset Level		3.9	V	

Note j:  $t_{RESTORE}$  starts from the time  $V_{CC}$  rises above  $V_{SWITCH}$ .

**AutoStore™/POWER-UP RECALL**

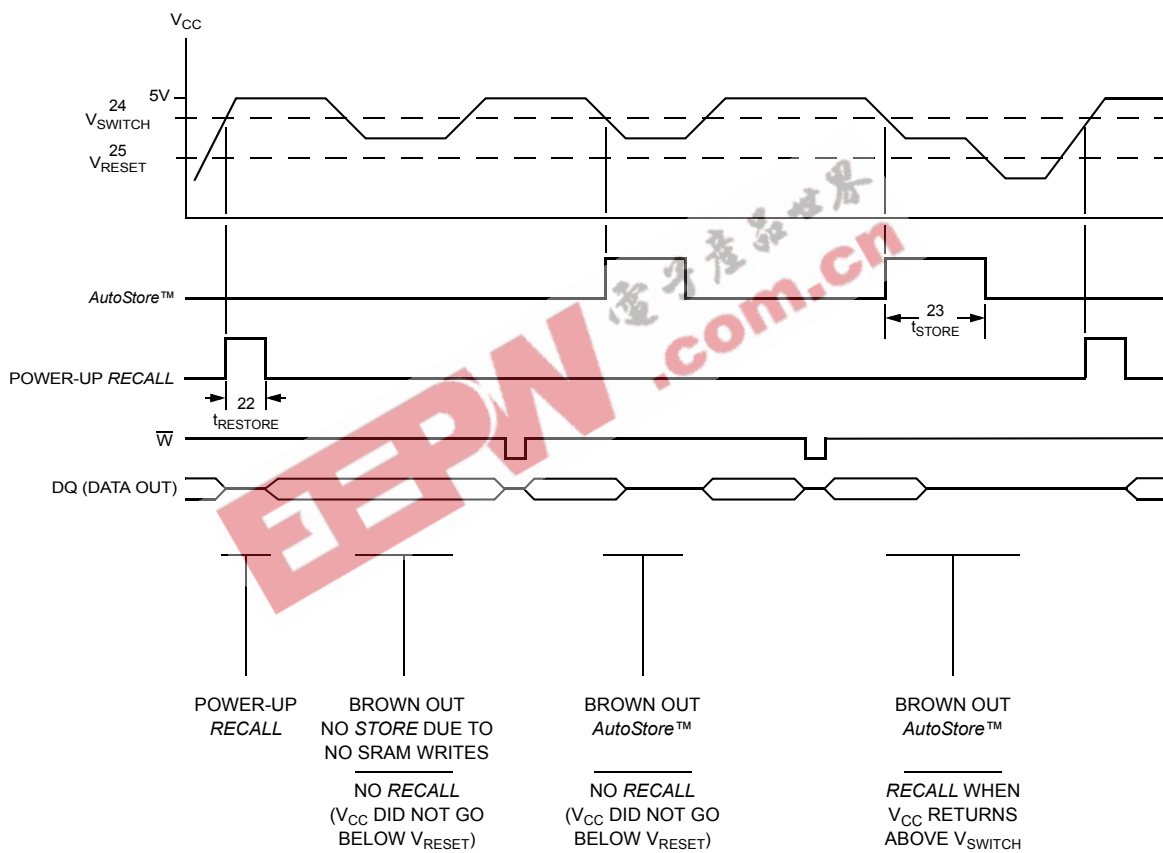

# STK1744

## SOFTWARE STORE/RECALL MODE SELECTION

$\bar{E}$	$\bar{W}$	A <sub>13</sub> - A <sub>0</sub> (hex)	MODE	I/O	NOTES
L	H	0E38 31C7 03E0 3C1F 303F 0FC0	Read SRAM Read SRAM Read SRAM Read SRAM Read SRAM Nonvolatile STORE	Output Data Output Data Output Data Output Data Output Data Output High Z	k, l
L	H	0E38 31C7 03E0 3C1F 303F 0C63	Read SRAM Read SRAM Read SRAM Read SRAM Read SRAM Nonvolatile RECALL	Output Data Output Data Output Data Output Data Output Data Output High Z	k, l

Note k: The six consecutive addresses must be in the order listed.  $\bar{W}$  must be high during all six consecutive cycles to enable a nonvolatile cycle.  
 Note l: While there are 15 addresses on the STK1744, only the lower 14 are used to control software modes.

## SOFTWARE STORE/RECALL CYCLE<sup>m, n</sup> (V<sub>CC</sub> = 5.0V ± 10%)

NO.	SYMBOLS	PARAMETER	STK1744-25		STK1744-35		STK1744-45		UNITS
			MIN	MAX	MIN	MAX	MIN	MAX	
26	t <sub>AVAV</sub>	STORE/RECALL Initiation Cycle Time	25		35		45		ns
27	t <sub>AVEL</sub> <sup>m</sup>	Address Set-up Time	0		0		0		ns
28	t <sub>ELEH</sub> <sup>m</sup>	Clock Pulse Width	20		25		30		ns
29	t <sub>ELAX</sub> <sup>f, m</sup>	Address Hold Time	20		20		20		ns
30	t <sub>RECALL</sub>	RECALL Duration		20		20		20	μs

Note m: The software sequence is clocked with  $\bar{E}$  controlled reads.  
 Note n: The six consecutive addresses must be in the order listed in the Software STORE/RECALL Mode Selection Table: (0E38, 31C7, 03E0, 3C1F, 303F, 0FC0) for a STORE cycle or (0E38, 31C7, 03E0, 3C1F, 303F, 0C63) for a RECALL cycle.  $\bar{W}$  must be high during all six consecutive cycles.

## SOFTWARE STORE/RECALL CYCLE: $\bar{E}$ Controlled

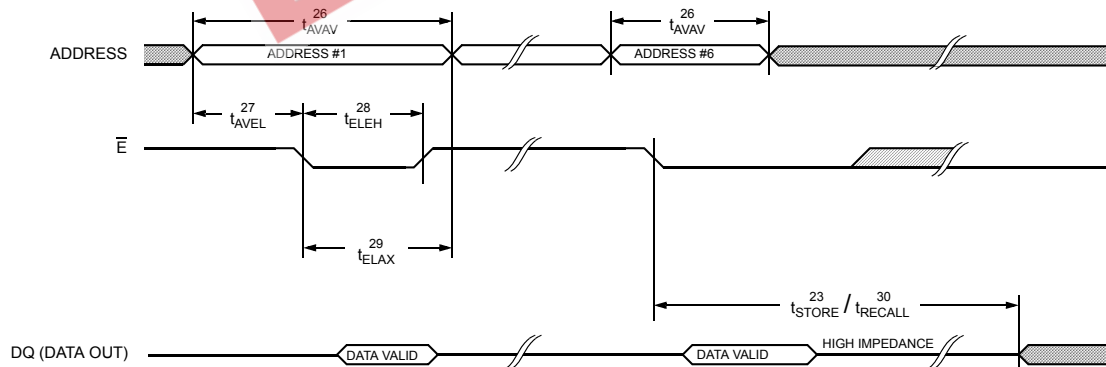

## DEVICE OPERATION

The STK1744 is a 32K x 8 nonvolatile static RAM with a full-function real-time clock (RTC). Nonvolatile data is preserved in integral *QuantumTrap™* Nonvolatile Elements and is not subject to battery failure or capacitor discharge. The real-time clock registers reside in the eight uppermost RAM locations, and contain century, year, month, date, day, hour, minute and second data in 24-hour BCD format. Corrections for the day of the month and leap years are made automatically. This nonvolatile time-keeping RAM is functionally similar to any JEDEC standard 32K x 8 SRAM.

The RTC registers are double-buffered to avoid access of incorrect data that could otherwise occur during clock update cycles. The double-buffered system prevents time loss by maintaining internal clock operation while time register data is accessed. The STK1744 contains integral power-fail circuitry that deselected the device when  $V_{CC}$  drops below  $V_{SWITCH}$ .

The STK1744 is a pin-compatible replacement for the ST Microelectronics M48T35 and the Dallas Semiconductor DS1744, but without the limitations of an embedded lithium battery. The Simtek module uses a double-layer high-value capacitor to maintain RTC operation on every power down for at least 30 days. The part can be soldered directly onto printed circuit boards and handled without concern for damaging or discharging internal batteries. Unlike some other RTCs, the STK1744 is Year 2000-compliant.

## NOISE CONSIDERATIONS

Note that the STK1744 is a high-speed memory and so must have a high-frequency bypass capacitor of approximately 0.1 $\mu$ F connected between  $V_{CC}$  and  $V_{SS}$ , using leads and traces that are as short as possible. As with all high-speed CMOS ICs, normal careful routing of power, ground and signals will help prevent noise problems.

## SRAM AND RTC READ

The STK1744 performs a READ cycle whenever  $\bar{E}$  and  $\bar{G}$  are low and  $\bar{W}$  is high. The address specified on pins  $A_{0-14}$  determines which of the 32,760 data bytes or 8 RTC registers will be accessed. When the READ is initiated by an address transition, the outputs will be valid after a delay of  $t_{AVQV}$  (READ cycle #1). If the READ is initiated by  $\bar{E}$  or  $\bar{G}$ , the outputs will be valid at  $t_{ELQV}$  or at  $t_{GLQV}$ , whichever is later (READ cycle #2). The data outputs will repeatedly respond to address changes within the  $t_{AVQV}$  access time without the need for transitions on any control input pins, and will remain valid until another address change or until  $\bar{E}$  or  $\bar{G}$  is brought high or  $\bar{W}$  is brought low.

Note that the eight most significant bytes of the address space are reserved for accessing the RTC registers, as shown in the RTC Register Map.

While the double-buffered RTC register structure reduces the chance of reading incorrect data from the clock, the user should halt internal updates to the

## RTC REGISTER MAP

ADDRESS (HEXADECIMAL)	BCD DATA								FUNCTION/RANGE
	D7	D6	D5	D4	D3	D2	D1	D0	
7FF8	W	R	10 Centuries		Centuries				Centuries: 00 - 39, Control
7FF9	X	10 Seconds			Seconds				Seconds: 00 - 59
7FFA	X	10 Minutes			Minutes				Minutes: 00 - 59
7FFB	X	X	10 Hours		Hours				Hours: 00 - 23
7FFC	1	FT	X	X	X	Days			Days: 01 - 07
7FFD	X	X	10 Dates		Dates				Dates: 01 - 31
7FFE	X	X	X	10 Mos.		Months			Months: 01 - 12
7FFF	10 Years			Years				Years: 00 - 99	
Key: R = Read Bit W = Write Bit 1 = Battery Flag high (there is no battery to fail) FT = Frequency test bit X = Don't Care									

## STK1744

---

STK1744 clock registers before reading clock data to prevent reading of data in transition. Stopping the internal register updates does not affect clock accuracy.

The updating process is stopped by writing a "1" to the read bit (the second most significant bit in the control register 7FF8), and will not restart until a "0" is written to the read bit. The RTC registers can then be read while the internal clock continues to run.

Within one second after a "0" is written to the read bit, all STK1744 registers are simultaneously updated.

### SRAM WRITE AND SETTING THE CLOCK

A WRITE cycle is performed whenever  $\bar{E}$  and  $\bar{W}$  are low. The address inputs must be stable prior to entering the WRITE cycle and must remain stable until either  $\bar{E}$  or  $\bar{W}$  goes high at the end of the cycle. The data on the common I/O pins DQ<sub>0-7</sub> will be written into the memory if it is valid  $t_{DVWH}$  before the end of a  $\bar{W}$  controlled WRITE or  $t_{DVEH}$  before the end of an  $\bar{E}$  controlled WRITE.

It is recommended that  $\bar{G}$  be kept high during the entire WRITE cycle to avoid data bus contention on the common I/O lines. If  $\bar{G}$  is left low, internal circuitry will turn off the output buffers  $t_{WLOZ}$  after  $\bar{W}$  goes low.

Setting the write bit (the MSB of the control register 7FF8) to a "1" halts updates to the STK1744 registers. The correct day, date and time can then be written into the registers in 24-hour BCD format. Resetting the write bit to "0" transfers those values to the actual clock counters, after which the clock resumes normal operation.

### FREQUENCY TEST BIT

As shown in the RTC Register Map, bit 6 of the day byte is the frequency test (FT) bit. When the FT bit is set to logic "1", the LSB of the seconds register will toggle at 512Hz. When the seconds register is being read, the DQ<sub>0</sub> line will toggle at 512Hz as long as conditions for access remain valid (i.e.,  $\bar{CE}$  low, OE low, WE high and the address for the seconds register valid and stable). The FT bit must be reset to "0" in order to resume reading the time from the seconds register.

### CLOCK ACCURACY

The STK1744 is guaranteed to be accurate to within  $\pm 1$  minute per month at 25°C. The part requires no additional calibration, and temperature variations will have a negligible effect in most applications.

### DATA RETENTION MODE

During normal operation ( $V_{CC} \geq 4.5V$ ), the STK1744 can be accessed with standard SRAM READ and WRITE cycles. However, when  $V_{CC}$  falls below the power-fail voltage,  $V_{SWITCH}$  (the voltage at which write protection occurs), access to the internal clock register and the SRAM is blocked. At this voltage, SRAM data is automatically stored to the integral Nonvolatile Elements, and power for the clock oscillator switches from the  $V_{CC}$  pin to the internal capacitor. The capacitor maintains clock activity and clock data until  $V_{CC}$  returns to its nominal level.

### SOFTWARE NONVOLATILE STORE

The STK1744 software STORE cycle is initiated by executing sequential READ cycles from six specific address locations. During the STORE cycle an erase of the previous nonvolatile data is first performed, followed by a program of the nonvolatile elements. The program operation copies the SRAM data into nonvolatile memory. Once a STORE cycle is initiated, further input and output are disabled until the cycle is completed.

Because a sequence of READs from specific addresses is used for STORE initiation, it is important that no other READ or WRITE accesses intervene in the sequence or the sequence will be aborted and no STORE or RECALL will take place.

To initiate the software STORE cycle, the following READ sequence must be performed:

- |                 |            |                      |
|-----------------|------------|----------------------|
| 1. Read address | 0E38 (hex) | Valid READ           |
| 2. Read address | 31C7 (hex) | Valid READ           |
| 3. Read address | 03E0 (hex) | Valid READ           |
| 4. Read address | 3C1F (hex) | Valid READ           |
| 5. Read address | 303F (hex) | Valid READ           |
| 6. Read address | 0FC0 (hex) | Initiate STORE cycle |

The software sequence must be clocked with  $\bar{E}$  controlled READs.

Once the sixth address in the sequence has been entered, the STORE cycle will commence and the SRAM will be disabled. The clock addresses may be



accessed during this period. It is important that READ cycles and not WRITE cycles be used in the sequence, although it is not necessary that  $\bar{G}$  be low for the sequence to be valid. After the  $t_{STORE}$  cycle time has been fulfilled, the SRAM will again be activated for READ and WRITE operation.

### SOFTWARE NONVOLATILE RECALL

A software *RECALL* cycle is initiated with a sequence of READ operations in a manner similar to the software *STORE* initiation. To initiate the *RECALL* cycle, the following sequence of READ operations must be performed:

1. Read address	0E38 (hex)	Valid READ
2. Read address	31C7 (hex)	Valid READ
3. Read address	03E0 (hex)	Valid READ
4. Read address	3C1F (hex)	Valid READ
5. Read address	303F (hex)	Valid READ
6. Read address	0C63 (hex)	Initiate <i>RECALL</i> cycle

Internally, *RECALL* is a two-step procedure. First, the SRAM data is cleared, and second, the nonvolatile information is transferred into the SRAM cells. After the  $t_{RECALL}$  cycle time the SRAM will once again be ready for READ and WRITE operations. The *RECALL* operation in no way alters the data in the Nonvolatile Elements. The nonvolatile data can be recalled an unlimited number of times. Note that the RTC registers are not affected by nonvolatile operations.

### AutoStore™ OPERATION

The STK1744 uses capacitance built into the module to perform an automatic *STORE* on power down.

In order to prevent unnecessary *STORE* operations, automatic *STORE*s will be ignored unless at least one WRITE operation has taken place since the most recent *STORE* or *RECALL* cycle. Software-initiated *STORE* cycles are performed regardless of whether a WRITE operation has taken place.

### POWER-UP RECALL

During power up, or after any low-power condition ( $V_{CC} < V_{RESET}$ ), an internal *RECALL* request will be latched. When  $V_{CC}$  once again exceeds  $V_{SWITCH}$ , a *RECALL* cycle will automatically be initiated and will take  $t_{RESTORE}$  to complete.

If the STK1744 is in a WRITE state at the end of power-up *RECALL*, the SRAM data will be corrupted. To help avoid this situation, a 10K Ohm resistor should be connected either between  $\bar{W}$  and system  $V_{CC}$  or between  $\bar{E}$  and system  $V_{CC}$ .

### HARDWARE PROTECT

The STK1744 offers hardware protection against inadvertent *STORE* and SRAM WRITE operation during low-voltage conditions. When  $V_{CC} < V_{SWITCH}$ , all software *STORE* operations and SRAM WRITES are inhibited.

### LOW AVERAGE ACTIVE POWER

The STK1744 draws significantly less current when it is cycled at times longer than 50ns. Figure 2 shows the relationship between  $I_{CC}$  and READ cycle time. Worst-case current consumption is shown for both CMOS and TTL input levels (commercial temperature range,  $V_{CC} = 5.5V$ , 100% duty cycle on chip enable). Figure 3 shows the same relationship for WRITE cycles. If the chip enable duty cycle is less than 100%, only standby current is drawn when the chip is disabled. The overall average current drawn by the STK1744 depends on the following items: 1) CMOS vs. TTL input levels; 2) the duty cycle of chip enable; 3) the overall cycle rate for accesses; 4) the ratio of READS to WRITES; 5) the operating temperature; 6) the  $V_{CC}$  level; and 7) I/O loading.

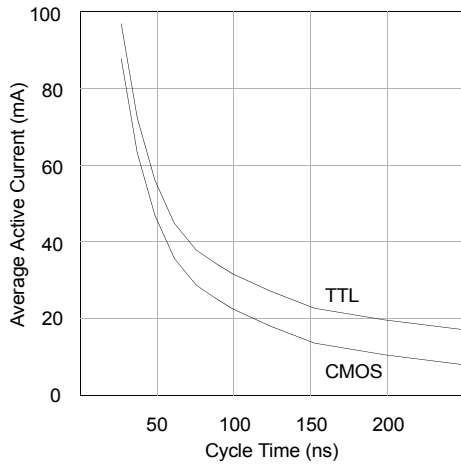

Figure 2:  $I_{CC}$  (max) Reads

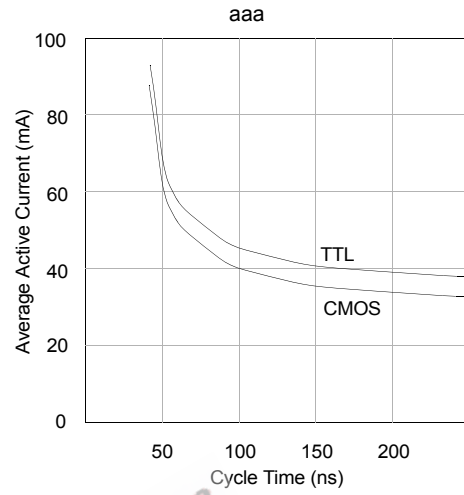

Figure 3:  $I_{CC}$  (max) Writes

EEPW.com.cn 电子产品世界

---

**ORDERING INFORMATION**

**STK1744 - D 25 I**

**Temperature Range**

Blank = Commercial (0 to 70°C)

I = Industrial (-40 to 85°C)

**Access Time**

25 = 25ns (commercial only)

35 = 35ns

45 = 45ns

**Package**

D = 600 mil Dual In-Line Module

Note: See Application Note  
for surface mount.

**STK1744**

---

**Document Revision History**

Revision	Date	Summary
0.0	January 2003	

