



STK12C68

STK12C68-M SMD#5962-94599

8K x 8 *AutoStore*[™] nvSRAM

QuantumTrap[™] CMOS

Nonvolatile Static RAM

FEATURES

- 25ns, 35ns, 45ns and 55ns Access Times
- “Hands-off” Automatic *STORE* with External 68μF Capacitor on Power Down
- *STORE* to Nonvolatile Elements Initiated by Hardware, Software or *AutoStore*[™] on Power Down
- *RECALL* to SRAM Initiated by Software or Power Restore
- 10mA Typical I_{CC} at 200ns Cycle Time
- Unlimited READ, WRITE and *RECALL* Cycles
- 1,000,000 *STORE* Cycles to Nonvolatile Elements (Commercial/Industrial)
- 100-Year Data Retention in Nonvolatile Elements (Commercial/Industrial)
- Commercial, Industrial and Military Temperatures
- 28-Pin SOIC, DIP and LCC Packages

DESCRIPTION

The Simtek STK12C68 is a fast static RAM with a nonvolatile element incorporated in each static memory cell. The SRAM can be read and written an unlimited number of times, while independent, non-volatile data resides in Nonvolatile Elements. Data transfers from the SRAM to the Nonvolatile Elements (the *STORE* operation) can take place automatically on power down. A 68μF or larger capacitor tied from V_{CAP} to ground guarantees the *STORE* operation, regardless of power-down slew rate or loss of power from “hot swapping”. Transfers from the Nonvolatile Elements to the SRAM (the *RECALL* operation) take place automatically on restoration of power. Initiation of *STORE* and *RECALL* cycles can also be software controlled by entering specific read sequences. A hardware *STORE* may be initiated with the HSB pin.

BLOCK DIAGRAM

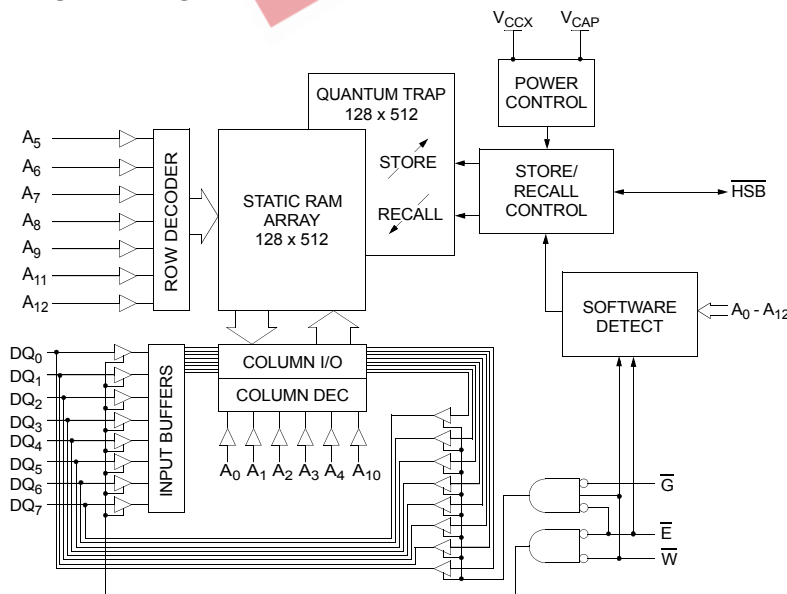

PIN CONFIGURATIONS

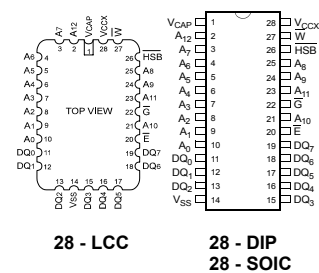

PIN NAMES

| | |
|-----------------------------------|---------------------------|
| A ₀ - A ₁₂ | Address Inputs |
| DQ ₀ - DQ ₇ | Data In/Out |
| \bar{E} | Chip Enable |
| \bar{W} | Write Enable |
| \bar{G} | Output Enable |
| HSB | Hardware Store Busy (I/O) |
| V _{CCX} | Power (+ 5V) |
| V _{CAP} | Capacitor |
| V _{SS} | Ground |

STK12C68

ABSOLUTE MAXIMUM RATINGS^a

Voltage on Input Relative to Ground -0.5V to 7.0V
 Voltage on Input Relative to V_{SS} -0.6V to (V_{CC} + 0.5V)
 Voltage on DQ₀₋₇ or HSB -0.5V to (V_{CC} + 0.5V)
 Temperature under Bias -55°C to 125°C
 Storage Temperature -65°C to 150°C
 Power Dissipation 1W
 DC Output Current (1 output at a time, 1s duration) 15mA

Note a: Stresses greater than those listed under "Absolute Maximum Ratings" may cause permanent damage to the device. This is a stress rating only, and functional operation of the device at conditions above those indicated in the operational sections of this specification is not implied. Exposure to absolute maximum rating conditions for extended periods may affect reliability.

DC CHARACTERISTICS

(V_{CC} = 5.0V ± 10%)^e

| SYMBOL | PARAMETER | COMMERCIAL | | INDUSTRIAL/ MILITARY | | UNITS | NOTES |
|-------------------------------|---|----------------------|----------------------|-------------------------|----------------------|-------|--|
| | | MIN | MAX | MIN | MAX | | |
| I _{CC1} ^b | Average V _{CC} Current | | 85 | | 90 | mA | t _{AVAV} = 25ns t _{AVAV} = 35ns t _{AVAV} = 45ns t _{AVAV} = 55ns |
| | | | 75 | | 75 | mA | |
| | | | 65 | | 65 | mA | |
| | | | 55 | | 55 | mA | |
| I _{CC2} ^c | Average V _{CC} Current during STORE | | 3 | | 3 | mA | All Inputs Don't Care, V _{CC} = max |
| I _{CC3} ^b | Average V _{CC} Current at t _{AVAV} = 200ns 5V, 25°C, Typical | | 10 | | 10 | mA | $\bar{W} \geq (V_{CC} - 0.2V)$ All Others Cycling, CMOS Levels |
| I _{CC4} ^c | Average V _{CAP} Current during AutoStore™ Cycle | | 2 | | 2 | mA | All Inputs Don't Care |
| I _{SB1} ^d | Average V _{CC} Current (Standby, Cycling TTL Input Levels) | | 27 | | 28 | mA | t _{AVAV} = 25ns, $\bar{E} \geq V_{IH}$ t _{AVAV} = 35ns, $\bar{E} \geq V_{IH}$ t _{AVAV} = 45ns, $\bar{E} \geq V_{IH}$ t _{AVAV} = 55ns, $\bar{E} \geq V_{IH}$ |
| | | | 23 | | 24 | mA | |
| | | | 20 | | 21 | mA | |
| | | | 19 | | 19 | mA | |
| I _{SB2} ^d | V _{CC} Standby Current (Standby, Stable CMOS Input Levels) | | 1.5 | | 2.5 | mA | $\bar{E} \geq (V_{CC} - 0.2V)$ All Others V _{IN} ≤ 0.2V or ≥ (V _{CC} - 0.2V) |
| I _{ILK} | Input Leakage Current | | ±1 | | ±1 | µA | V _{CC} = max V _{IN} = V _{SS} to V _{CC} |
| I _{OLK} | Off-State Output Leakage Current | | ±5 | | ±5 | µA | V _{CC} = max V _{IN} = V _{SS} to V _{CC} , \bar{E} or $\bar{G} \geq V_{IH}$ |
| V _{IH} | Input Logic "1" Voltage | 2.2 | V _{CC} + .5 | 2.2 | V _{CC} + .5 | V | All Inputs |
| V _{IL} | Input Logic "0" Voltage | V _{SS} - .5 | 0.8 | V _{SS} - .5 | 0.8 | V | All Inputs |
| V _{OH} | Output Logic "1" Voltage | 2.4 | | 2.4 | | V | I _{OUT} = -4mA except HSB |
| V _{OL} | Output Logic "0" Voltage | | 0.4 | | 0.4 | V | I _{OUT} = 8mA except HSB |
| V _{BL} | Logic "0" Voltage on HSB Output | | 0.4 | | 0.4 | V | I _{OUT} = 3mA |
| T _A | Operating Temperature | 0 | 70 | -40/-55 | 85/125 | °C | |

Note b: I_{CC1} and I_{CC3} are dependent on output loading and cycle rate. The specified values are obtained with outputs unloaded.
 Note c: I_{CC2} and I_{CC4} are the average currents required for the duration of the respective STORE cycles (t_{STORE}).
 Note d: $\bar{E} \geq V_{IH}$ will not produce standby current levels until any nonvolatile cycle in progress has timed out.
 Note e: V_{CC} reference levels throughout this datasheet refer to V_{CCX} if that is where the power supply connection is made, or V_{CAP} if V_{CCX} is connected to ground.

AC TEST CONDITIONS

| | |
|--|--------------|
| Input Pulse Levels | 0V to 3V |
| Input Rise and Fall Times | ≤ 5ns |
| Input and Output Timing Reference Levels | 1.5V |
| Output Load | See Figure 1 |

CAPACITANCE^f (T_A = 25°C, f = 1.0MHz)

| SYMBOL | PARAMETER | MAX | UNITS | CONDITIONS |
|------------------|--------------------|-----|-------|--------------|
| C _{IN} | Input Capacitance | 8 | pF | ΔV = 0 to 3V |
| C _{OUT} | Output Capacitance | 7 | pF | ΔV = 0 to 3V |

Note f: These parameters are guaranteed but not tested.

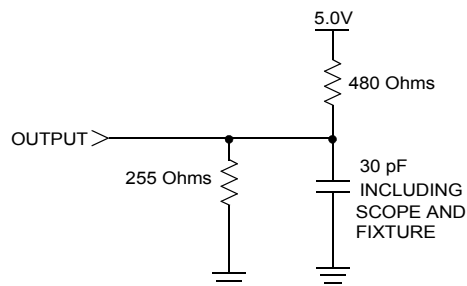

Figure 1: AC Output Loading

SRAM READ CYCLES #1 & #2

(V_{CC} = 5.0V ± 10%)^e

| NO. | SYMBOLS | | PARAMETER | STK12C68-25 | | STK12C68-35 | | STK12C68-45 | | STK12C68-55 | | UNITS |
|-----|----------------------------------|------------------|-----------------------------------|-------------|-----|-------------|-----|-------------|-----|-------------|-----|-------|
| | #1, #2 | Alt. | | MIN | MAX | MIN | MAX | MIN | MAX | MIN | MAX | |
| 1 | t _{ELQV} | t _{ACS} | Chip Enable Access Time | | 25 | | 35 | | 45 | | 55 | ns |
| 2 | t _{AVAV} ^g | t _{RC} | Read Cycle Time | 25 | | 35 | | 45 | | 55 | | ns |
| 3 | t _{AVQV} ^h | t _{AA} | Address Access Time | | 25 | | 35 | | 45 | | 55 | ns |
| 4 | t _{GLQV} | t _{OE} | Output Enable to Data Valid | | 10 | | 15 | | 20 | | 35 | ns |
| 5 | t _{AXQX} ^h | t _{OH} | Output Hold after Address Change | 5 | | 5 | | 5 | | 5 | | ns |
| 6 | t _{ELQX} | t _{LZ} | Chip Enable to Output Active | 5 | | 5 | | 5 | | 5 | | ns |
| 7 | t _{EHQZ} ⁱ | t _{HZ} | Chip Disable to Output Inactive | | 10 | | 10 | | 12 | | 12 | ns |
| 8 | t _{GLQX} | t _{OLZ} | Output Enable to Output Active | 0 | | 0 | | 0 | | 0 | | ns |
| 9 | t _{GHQZ} ⁱ | t _{OHZ} | Output Disable to Output Inactive | | 10 | | 10 | | 12 | | 12 | ns |
| 10 | t _{ELICCH} ^f | t _{PA} | Chip Enable to Power Active | 0 | | 0 | | 0 | | 0 | | ns |
| 11 | t _{EHICCL} ^f | t _{PS} | Chip Disable to Power Standby | | 25 | | 35 | | 45 | | 55 | ns |

Note g: \overline{W} and \overline{HSB} must be high during SRAM READ cycles.
 Note h: Device is continuously selected with \overline{E} and \overline{G} both low.
 Note i: Measured ± 200mV from steady state output voltage.

SRAM READ CYCLE #1: Address Controlled^{g, h}

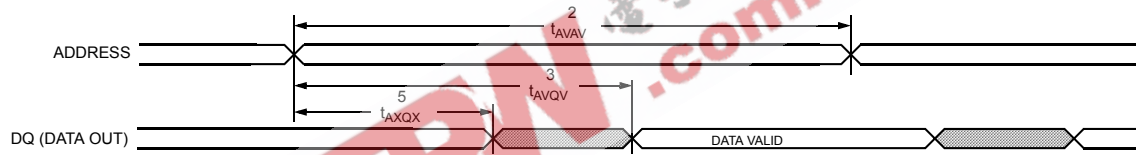

SRAM READ CYCLE #2: \overline{E} Controlled^g

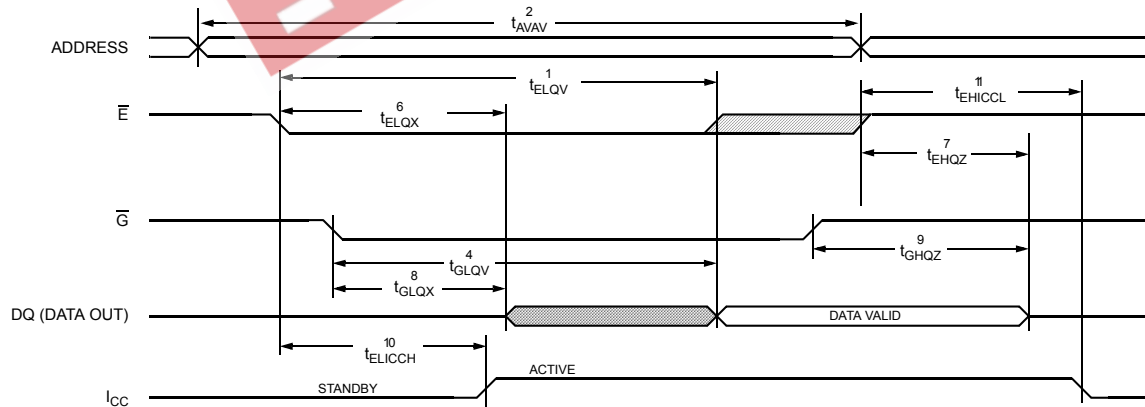

STK12C68

SRAM WRITE CYCLES #1 & #2

($V_{CC} = 5.0V \pm 10\%$)^e

| NO. | SYMBOLS | | | PARAMETER | STK12C68-25 | | STK12C68-35 | | STK12C68-45 | | STK12C68-55 | | UNITS |
|-----|------------------|------------|----------|----------------------------------|-------------|-----|-------------|-----|-------------|-----|-------------|-----|-------|
| | #1 | #2 | Alt. | | MIN | MAX | MIN | MAX | MIN | MAX | MIN | MAX | |
| 12 | t_{AVAV} | t_{AVAV} | t_{WC} | Write Cycle Time | 25 | | 35 | | 45 | | 55 | | ns |
| 13 | t_{WLWH} | t_{WLEH} | t_{WP} | Write Pulse Width | 20 | | 25 | | 30 | | 45 | | ns |
| 14 | t_{ELWH} | t_{ELEH} | t_{CW} | Chip Enable to End of Write | 20 | | 25 | | 30 | | 45 | | ns |
| 15 | t_{DVWH} | t_{DVEH} | t_{DW} | Data Set-up to End of Write | 10 | | 12 | | 15 | | 25 | | ns |
| 16 | t_{WHDX} | t_{EHDX} | t_{DH} | Data Hold after End of Write | 0 | | 0 | | 0 | | 0 | | ns |
| 17 | t_{AVWH} | t_{AVEH} | t_{AW} | Address Set-up to End of Write | 20 | | 25 | | 30 | | 45 | | ns |
| 18 | t_{AVWL} | t_{AVEL} | t_{AS} | Address Set-up to Start of Write | 0 | | 0 | | 0 | | 0 | | ns |
| 19 | t_{WHAX} | t_{EHAX} | t_{WR} | Address Hold after End of Write | 0 | | 0 | | 0 | | 0 | | ns |
| 20 | $t_{WLOZ}^{i,j}$ | | t_{WZ} | Write Enable to Output Disable | | 10 | | 13 | | 14 | | 15 | ns |
| 21 | t_{WHQX} | | t_{OW} | Output Active after End of Write | 5 | | 5 | | 5 | | 5 | | ns |

Note j: If \bar{W} is low when \bar{E} goes low, the outputs remain in the high-impedance state.

Note k: \bar{E} or \bar{W} must be $\geq V_{IH}$ during address transitions.

Note l: HSB must be high during SRAM WRITE cycles.

SRAM WRITE CYCLE #1: \bar{W} Controlled^{k, l}

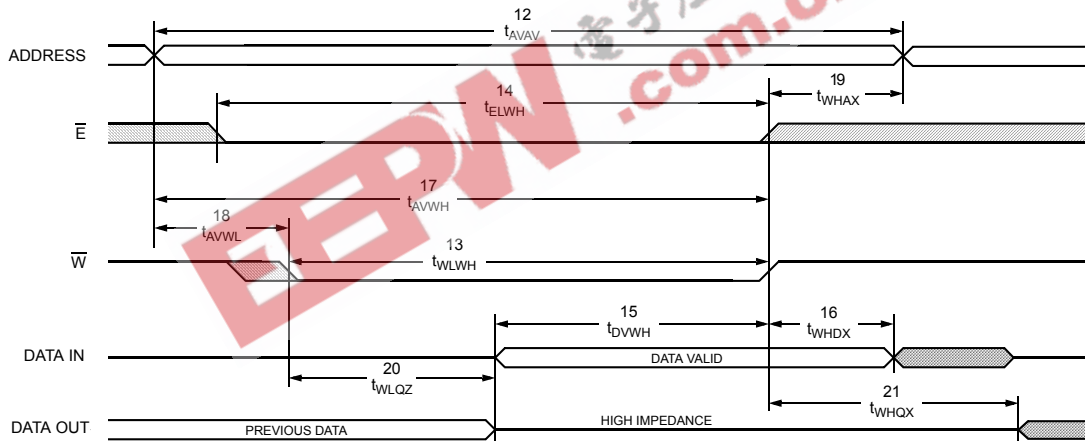

SRAM WRITE CYCLE #2: \bar{E} Controlled^{k, l}

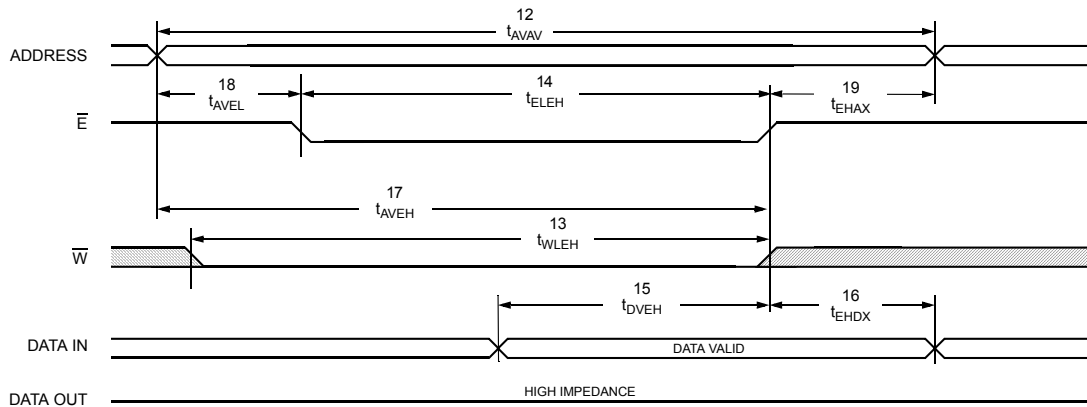

HARDWARE MODE SELECTION

| \bar{E} | \bar{W} | \bar{HSB} | A ₁₂ - A ₀ (hex) | MODE | I/O | POWER | NOTES |
|-----------|-----------|-------------|--|--|--|----------------------------|-------|
| H | X | H | X | Not Selected | Output High Z | Standby | |
| L | H | H | X | Read SRAM | Output Data | Active | o |
| L | L | H | X | Write SRAM | Input Data | Active | |
| X | X | L | X | Nonvolatile <i>STORE</i> | Output High Z | I _{CC2} | m |
| L | H | H | 0000 1555 0AAA 1FFF 10F0 0F0F | Read SRAM Read SRAM Read SRAM Read SRAM Read SRAM Nonvolatile <i>STORE</i> | Output Data Output Data Output Data Output Data Output Data Output High Z | Active I _{CC2} | n, o |
| L | H | H | 0000 1555 0AAA 1FFF 10F0 0F0E | Read SRAM Read SRAM Read SRAM Read SRAM Read SRAM Nonvolatile <i>RECALL</i> | Output Data Output Data Output Data Output Data Output Data Output High Z | Active | n, o |

Note m: \bar{HSB} *STORE* operation occurs only if an SRAM WRITE has been done since the last nonvolatile cycle. After the *STORE* (if any) completes, the part will go into standby mode, inhibiting all operations until \bar{HSB} rises.

Note n: The six consecutive addresses must be in the order listed. \bar{W} must be high during all six consecutive cycles to enable a nonvolatile cycle.

Note o: I/O state assumes $\bar{G} \leq V_{IL}$. Activation of nonvolatile cycles does not depend on state of \bar{G} .

HARDWARE STORE CYCLE

(V_{CC} = 5.0V ± 10%)^e

| NO. | SYMBOLS | | PARAMETER | STK12C68 | | UNITS | NOTES |
|-----|----------------------|-------------------|---|----------|-----|-------|-------|
| | Standard | Alternate | | MIN | MAX | | |
| 22 | t _{STORE} | t _{HLHZ} | <i>STORE</i> Cycle Duration | | 10 | ms | i, p |
| 23 | t _{DELAY} | t _{HLQZ} | Time Allowed to Complete SRAM Cycle | 1 | | μs | i, q |
| 24 | t _{RECOVER} | t _{HHQX} | Hardware <i>STORE</i> High to Inhibit Off | | 700 | ns | p, r |
| 25 | t _{HLHX} | | Hardware <i>STORE</i> Pulse Width | 15 | | ns | |
| 26 | t _{HLBL} | | Hardware <i>STORE</i> Low to Store Busy | | 300 | ns | |

Note p: \bar{E} and \bar{G} low for output behavior.

Note q: \bar{E} and \bar{G} low and \bar{W} high for output behavior.

Note r: t_{RECOVER} is only applicable after t_{STORE} is complete.

HARDWARE STORE CYCLE

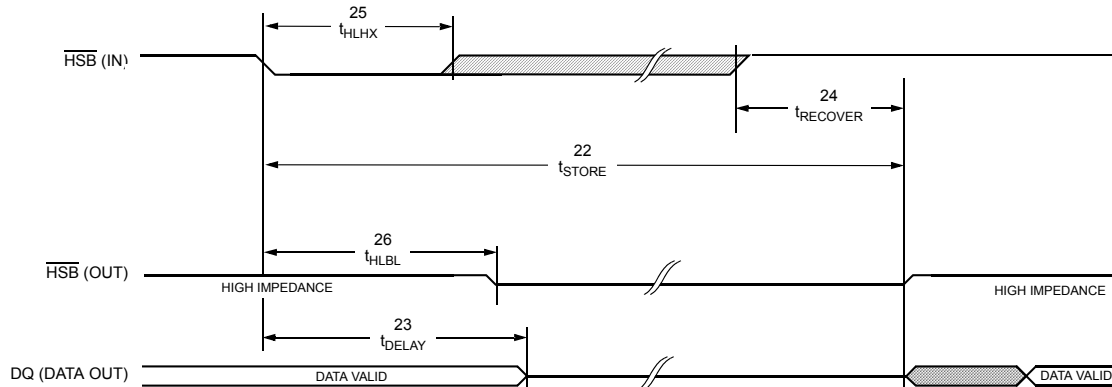

STK12C68

AutoStore™/POWER-UP RECALL

($V_{CC} = 5.0V \pm 10\%$)^e

| NO. | SYMBOLS | | PARAMETER | STK12C68 | | UNITS | NOTES |
|-----|---------------|------------|--|----------|-----|---------|---------|
| | Standard | Alternate | | MIN | MAX | | |
| 27 | $t_{RESTORE}$ | | Power-up <i>RECALL</i> Duration | | 550 | μ s | s |
| 28 | t_{STORE} | t_{HLHZ} | <i>STORE</i> Cycle Duration | | 10 | ms | p, q, t |
| 29 | t_{VSBL} | | Low Voltage Trigger (V_{SWITCH}) to \overline{HSB} Low | | 300 | ns | l |
| 30 | t_{DELAY} | t_{BLQZ} | Time Allowed to Complete SRAM Cycle | 1 | | μ s | p |
| 31 | V_{SWITCH} | | Low Voltage Trigger Level | 4.0 | 4.5 | V | |
| 32 | V_{RESET} | | Low Voltage Reset Level | | 3.9 | V | |

Note s: $t_{RESTORE}$ starts from the time V_{CC} rises above V_{SWITCH} .

Note t: \overline{HSB} is asserted low for 1μ s when V_{CAP} drops through V_{SWITCH} . If an SRAM WRITE has not taken place since the last nonvolatile cycle, \overline{HSB} will be released and no *STORE* will take place.

AutoStore™/POWER-UP RECALL

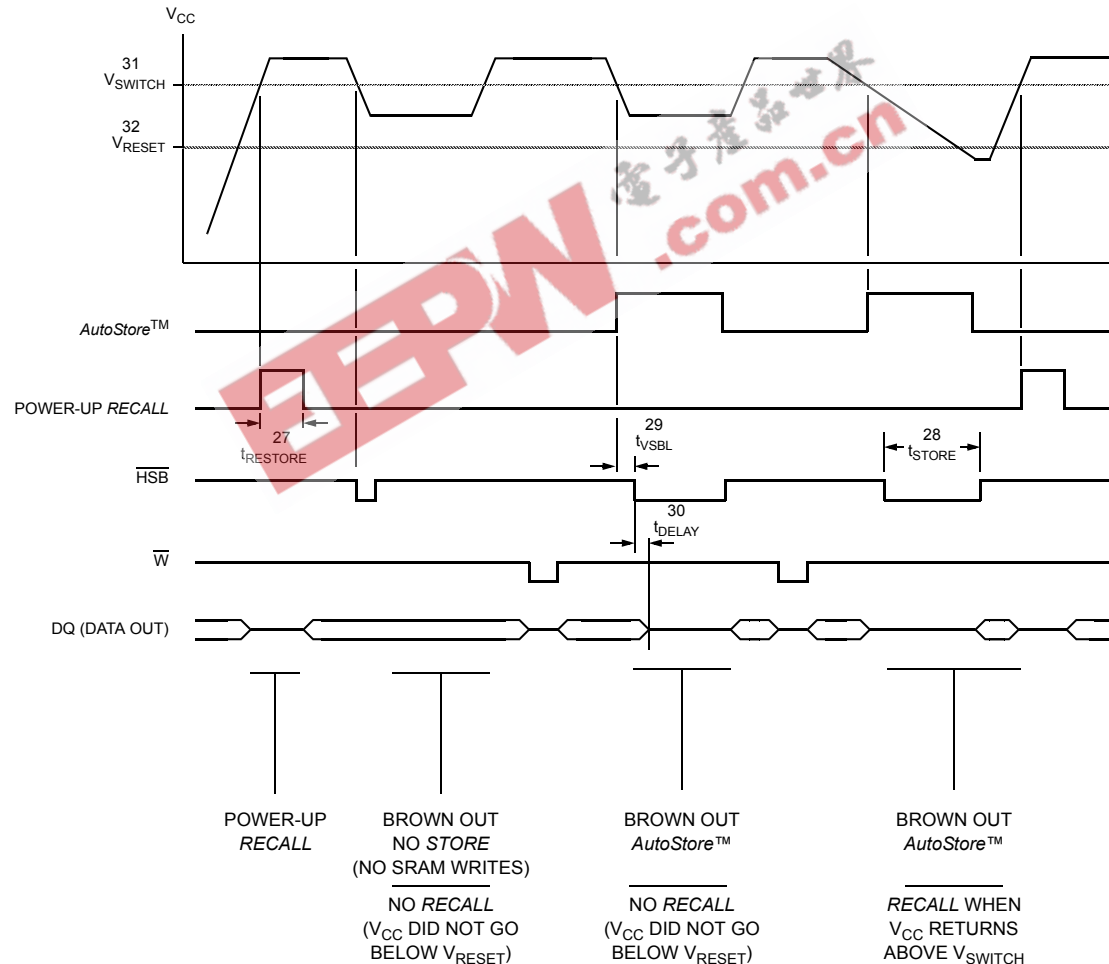

SOFTWARE-CONTROLLED STORE/RECALL CYCLE^V

($V_{CC} = 5.0V \pm 10\%$)^e

| NO. | SYMBOLS | | PARAMETER | STK12C68-25 | | STK12C68-35 | | STK12C68-45 | | STK12C68-55 | | UNITS | NOTES |
|-----|--------------|-----------|------------------------------------|-------------|-----|-------------|-----|-------------|-----|-------------|-----|---------|-------|
| | Standard | Alternate | | MIN | MAX | MIN | MAX | MIN | MAX | MIN | MAX | | |
| 33 | t_{AVAV} | t_{RC} | STORE/RECALL Initiation Cycle Time | 25 | | 35 | | 45 | | 55 | | ns | p |
| 34 | t_{AVEL} | t_{AS} | Address Set-up Time | 0 | | 0 | | 0 | | 0 | | ns | u |
| 35 | t_{ELEH} | t_{CW} | Clock Pulse Width | 20 | | 25 | | 30 | | 30 | | ns | u |
| 36 | t_{ELAX} | | Address Hold Time | 20 | | 20 | | 20 | | 20 | | ns | u |
| 37 | t_{RECALL} | | RECALL Duration | | 20 | | 20 | | 20 | | 20 | μ s | |

Note u: The software sequence is clocked with \bar{E} controlled READs.

Note v: The six consecutive addresses must be in the order listed in the Hardware Mode Selection Table: (0000, 1555, 0AAA, 1FFF, 10F0, 0F0F) for a STORE cycle or (0000, 1555, 0AAA, 1FFF, 10F0, 0F0E) for a RECALL cycle. \bar{W} must be high during all six consecutive cycles.

SOFTWARE STORE/RECALL CYCLE: \bar{E} Controlled^V

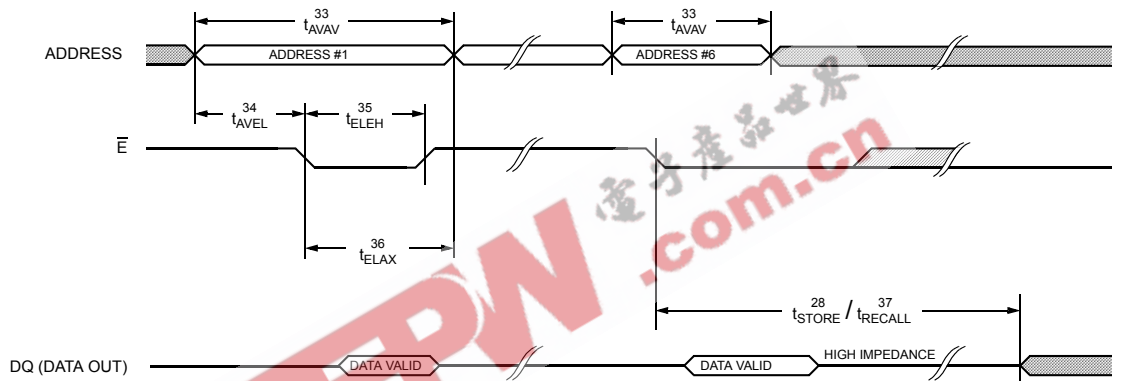

DEVICE OPERATION

The STK12C68 has two separate modes of operation: SRAM mode and nonvolatile mode. In SRAM mode, the memory operates as a standard fast static RAM. In nonvolatile mode, data is transferred from SRAM to Nonvolatile Elements (the *STORE* operation) or from Nonvolatile Elements to SRAM (the *RECALL* operation). In this mode SRAM functions are disabled.

NOISE CONSIDERATIONS

The STK12C68 is a high-speed memory and so must have a high-frequency bypass capacitor of approximately 0.1 μ F connected between V_{CAP} and V_{SS} , using leads and traces that are as short as possible. As with all high-speed CMOS ICs, normal careful routing of power, ground and signals will help prevent noise problems.

SRAM READ

The STK12C68 performs a READ cycle whenever \bar{E} and \bar{G} are low and \bar{W} and \overline{HSB} are high. The address specified on pins A_{0-12} determines which of the 8,192 data bytes will be accessed. When the READ is initiated by an address transition, the outputs will be valid after a delay of t_{AVOY} (READ cycle #1). If the READ is initiated by \bar{E} or \bar{G} , the outputs will be valid at t_{ELQV} or at t_{GLQV} , whichever is later (READ cycle #2). The data outputs will repeatedly respond to address changes within the t_{AVQV} access time without the need for transitions on any control input pins, and will remain valid until another address change or until \bar{E} or \bar{G} is brought high, or \bar{W} or \overline{HSB} is brought low.

SRAM WRITE

A WRITE cycle is performed whenever \bar{E} and \bar{W} are low and \overline{HSB} is high. The address inputs must be stable prior to entering the WRITE cycle and must remain stable until either \bar{E} or \bar{W} goes high at the end of the cycle. The data on the common I/O pins DQ_{0-7} will be written into the memory if it is valid t_{DVWH} before the end of a \bar{W} controlled WRITE or t_{DVEH} before the end of an \bar{E} controlled WRITE.

It is recommended that \bar{G} be kept high during the entire WRITE cycle to avoid data bus contention on common I/O lines. If \bar{G} is left low, internal circuitry will turn off the output buffers t_{WLOZ} after \bar{W} goes low.

POWER-UP RECALL

During power up, or after any low-power condition ($V_{CAP} < V_{RESET}$), an internal *RECALL* request will be latched. When V_{CAP} once again exceeds the sense voltage of V_{SWITCH} , a *RECALL* cycle will automatically be initiated and will take $t_{RESTORE}$ to complete.

If the STK12C68 is in a WRITE state at the end of power-up *RECALL*, the SRAM data will be corrupted. To help avoid this situation, a 10K Ohm resistor should be connected either between \bar{W} and system V_{CC} or between \bar{E} and system V_{CC} .

SOFTWARE NONVOLATILE STORE

The STK12C68 software *STORE* cycle is initiated by executing sequential \bar{E} controlled READ cycles from six specific address locations. During the *STORE* cycle an erase of the previous nonvolatile data is first performed, followed by a program of the nonvolatile elements. The program operation copies the SRAM data into nonvolatile memory. Once a *STORE* cycle is initiated, further input and output are disabled until the cycle is completed.

Because a sequence of READs from specific addresses is used for *STORE* initiation, it is important that no other READ or WRITE accesses intervene in the sequence, or the sequence will be aborted and no *STORE* or *RECALL* will take place.

To initiate the software *STORE* cycle, the following READ sequence must be performed:

- | | | |
|-----------------|------------|-----------------------------|
| 1. Read address | 0000 (hex) | Valid READ |
| 2. Read address | 1555 (hex) | Valid READ |
| 3. Read address | 0AAA (hex) | Valid READ |
| 4. Read address | 1FFF (hex) | Valid READ |
| 5. Read address | 10F0 (hex) | Valid READ |
| 6. Read address | 0F0F (hex) | Initiate <i>STORE</i> cycle |

The software sequence must be clocked with \bar{E} controlled READs.

Once the sixth address in the sequence has been entered, the *STORE* cycle will commence and the chip will be disabled. It is important that READ cycles and not WRITE cycles be used in the sequence, although it is not necessary that \bar{G} be low for the sequence to be valid. After the t_{STORE} cycle time has been fulfilled, the SRAM will again be activated for READ and WRITE operation.

SOFTWARE NONVOLATILE RECALL

A software *RECALL* cycle is initiated with a sequence of READ operations in a manner similar to the software *STORE* initiation. To initiate the *RECALL* cycle, the following sequence of \bar{E} controlled READ operations must be performed:

- | | | |
|-----------------|------------|------------------------------|
| 1. Read address | 0000 (hex) | Valid READ |
| 2. Read address | 1555 (hex) | Valid READ |
| 3. Read address | 0AAA (hex) | Valid READ |
| 4. Read address | 1FFF (hex) | Valid READ |
| 5. Read address | 10F0 (hex) | Valid READ |
| 6. Read address | 0F0E (hex) | Initiate <i>RECALL</i> cycle |

Internally, *RECALL* is a two-step procedure. First, the SRAM data is cleared, and second, the nonvolatile information is transferred into the SRAM cells. After the t_{RECALL} cycle time the SRAM will once again be ready for READ and WRITE operations. The *RECALL* operation in no way alters the data in the Nonvolatile Elements. The nonvolatile data can be recalled an unlimited number of times.

AutoStore™ OPERATION

The STK12C68 can be powered in one of three modes.

During normal *AutoStore™* operation, the STK12C68 will draw current from V_{CCX} to charge a capacitor connected to the V_{CAP} pin. This stored charge will be used by the chip to perform a single *STORE* operation. After power up, when the voltage on the V_{CAP} pin drops below $V_{SWITCH1}$, the part will automatically disconnect the V_{CAP} pin from V_{CCX} and initiate a *STORE* operation.

Figure 2 shows the proper connection of capacitors for automatic store operation. A charge storage capacitor having a capacity of between 68 μ F and 220 μ F ($\pm 20\%$) rated at 6V should be provided.

In system power mode (Figure 3), both V_{CCX} and V_{CAP} are connected to the +5V power supply without the 68 μ F capacitor. In this mode the *AutoStore™* function of the STK12C68 will operate on the stored system charge as power goes down. The user must, however, guarantee that V_{CCX} does not drop below 3.6V during the 10ms *STORE* cycle.

If an automatic *STORE* on power loss is not required, then V_{CCX} can be tied to ground and +5V applied to V_{CAP} (Figure 4). This is the *AutoStore™* Inhibit mode, in which the *AutoStore™* function is disabled. If the STK12C68 is operated in this configuration, references to V_{CCX} should be changed to V_{CAP} throughout this data sheet. In this mode, *STORE* operations may be triggered through software control or the \overline{HSB} pin. It is not permissible to change between these three options “on the fly”.

In order to prevent unneeded *STORE* operations, automatic *STORES* as well as those initiated by externally driving \overline{HSB} low will be ignored unless at least one WRITE operation has taken place since the most recent *STORE* or *RECALL* cycle. Software-initiated *STORE* cycles are performed regardless of whether a WRITE operation has taken place. An optional pull-up resistor is shown connected to \overline{HSB} . This can be used to signal the system that the *AutoStore™* cycle is in progress.

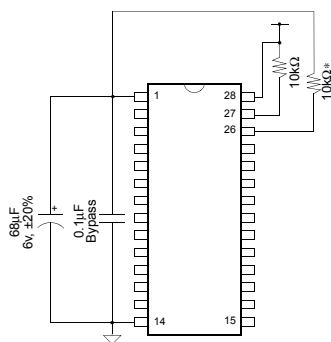

Figure 2: *AutoStore™* Mode

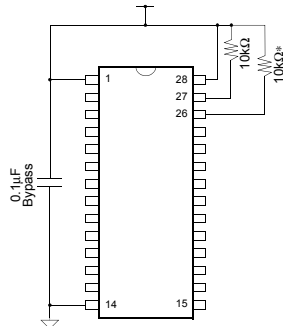

Figure 3: System Power Mode

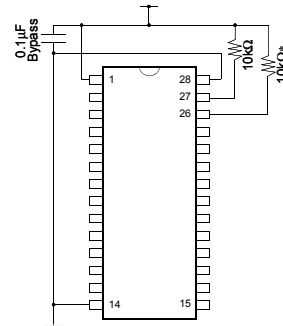

Figure 4: *AutoStore™* Inhibit Mode

*If \overline{HSB} is not used, it should be left unconnected.

HSB OPERATION

The STK12C68 provides the $\overline{\text{HSB}}$ pin for controlling and acknowledging the *STORE* operations. The $\overline{\text{HSB}}$ pin is used to request a hardware *STORE* cycle. When the $\overline{\text{HSB}}$ pin is driven low, the STK12C68 will conditionally initiate a *STORE* operation after t_{DELAY} ; an actual *STORE* cycle will only begin if a *WRITE* to the SRAM took place since the last *STORE* or *RECALL* cycle. The $\overline{\text{HSB}}$ pin acts as an open drain driver that is internally driven low to indicate a busy condition while the *STORE* (initiated by any means) is in progress.

SRAM READ and *WRITE* operations that are in progress when $\overline{\text{HSB}}$ is driven low by any means are given time to complete before the *STORE* operation is initiated. After $\overline{\text{HSB}}$ goes low, the STK12C68 will continue SRAM operations for t_{DELAY} . During t_{DELAY} , multiple SRAM READ operations may take place. If a *WRITE* is in progress when $\overline{\text{HSB}}$ is pulled low it will be allowed a time, t_{DELAY} , to complete. However, any SRAM *WRITE* cycles requested after $\overline{\text{HSB}}$ goes low will be inhibited until $\overline{\text{HSB}}$ returns high.

The $\overline{\text{HSB}}$ pin can be used to synchronize multiple STK12C68s while using a single larger capacitor. To operate in this mode the $\overline{\text{HSB}}$ pin should be connected together to the $\overline{\text{HSB}}$ pins from the other STK12C68s. An external pull-up resistor to +5V is required since $\overline{\text{HSB}}$ acts as an open drain pull down. The V_{CAP} pins from the other STK12C68 parts can be tied together and share a single capacitor. The capacitor size must be scaled by the number of devices connected to it. When any one of the STK12C68s detects a power loss and asserts $\overline{\text{HSB}}$, the common $\overline{\text{HSB}}$ pin will cause all parts to request a *STORE* cycle (a *STORE* will take place in those STK12C68s that have been written since the last nonvolatile cycle).

During any *STORE* operation, regardless of how it was initiated, the STK12C68 will continue to drive the $\overline{\text{HSB}}$ pin low, releasing it only when the *STORE* is complete. Upon completion of the *STORE* operation the STK12C68 will remain disabled until the $\overline{\text{HSB}}$ pin returns high.

If $\overline{\text{HSB}}$ is not used, it should be left unconnected.

PREVENTING STORES

The *STORE* function can be disabled on the fly by holding $\overline{\text{HSB}}$ high with a driver capable of sourcing 30mA at a V_{OH} of at least 2.2V, as it will have to overpower the internal pull-down device that drives $\overline{\text{HSB}}$ low for 20 μ s at the onset of a *STORE*. When the STK12C68 is connected for *AutoStore*TM operation (system V_{CC} connected to V_{CCX} and a 68 μ F capacitor on V_{CAP}) and V_{CC} crosses V_{SWITCH} on the way down, the STK12C68 will attempt to pull $\overline{\text{HSB}}$ low; if $\overline{\text{HSB}}$ doesn't actually get below V_{IL} , the part will stop trying to pull $\overline{\text{HSB}}$ low and abort the *STORE* attempt.

HARDWARE PROTECT

The STK12C68 offers hardware protection against inadvertent *STORE* operation and SRAM *WRITES* during low-voltage conditions. When $V_{\text{CAP}} < V_{\text{SWITCH}}$, all externally initiated *STORE* operations and SRAM *WRITES* are inhibited.

*AutoStore*TM can be completely disabled by tying V_{CCX} to ground and applying +5V to V_{CAP} . This is the *AutoStore*TM Inhibit mode; in this mode, *STORE*s are only initiated by explicit request using either the software sequence or the $\overline{\text{HSB}}$ pin.

LOW AVERAGE ACTIVE POWER

The STK12C68 draws significantly less current when it is cycled at times longer than 50ns. Figure 5 shows the relationship between I_{CC} and READ cycle time. Worst-case current consumption is shown for both CMOS and TTL input levels (commercial temperature range, $V_{\text{CC}} = 5.5\text{V}$, 100% duty cycle on chip enable). Figure 6 shows the same relationship for *WRITE* cycles. If the chip enable duty cycle is less than 100%, only standby current is drawn when the chip is disabled. The overall average current drawn by the STK12C68 depends on the following items: 1) CMOS vs. TTL input levels; 2) the duty cycle of chip enable; 3) the overall cycle rate for accesses; 4) the ratio of *READS* to *WRITES*; 5) the operating temperature; 6) the V_{CC} level; and 7) I/O loading.

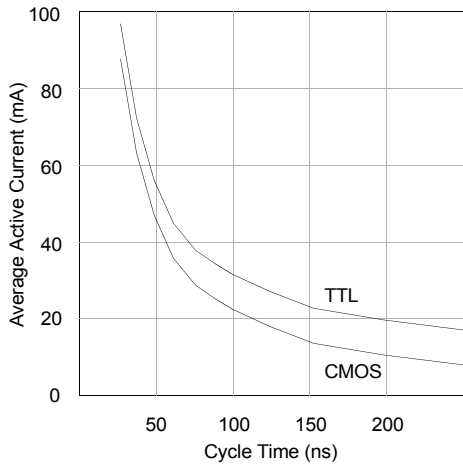

Figure 5: I_{cc} (max) Reads

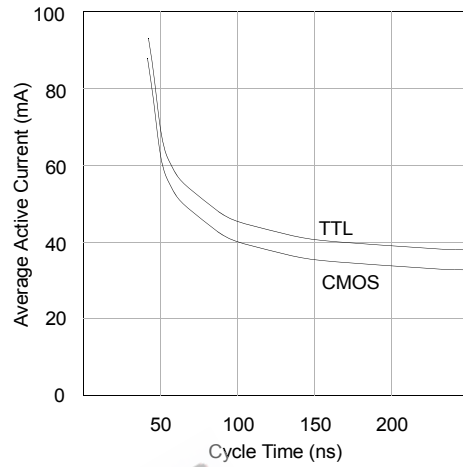

Figure 6: I_{cc} (max) Writes

EEPW.com.cn 电子产品世界

ORDERING INFORMATION

STK12C68 - 5 P F 45 I

Temperature Range

- Blank = Commercial (0 to 70°C)
- I = Industrial (-40 to 85°C)
- M = Military (-55 to 125°C)

Access Time

- 25 = 25ns
- 35 = 35ns
- 45 = 45ns
- 55 = 55ns

Lead Finish (Plastic only)

- Blank = 85%Sn/15%Pb
- F = 100% Sn (Matte Tin)

Package

- P = Plastic 28-pin 300 mil DIP
- W = Plastic 28-pin 600 mil DIP
- S = Plastic 28-pin 350 mil SOIC
- C = Ceramic 28-pin 300 mil DIP (gold lead finish)
- K = Ceramic 28-pin 300 mil DIP (solder dip finish)
- L = Ceramic 28 pin LCC

Retention / Endurance

- Blank = Comm/Ind (100 years/10⁶cycles)
- 5 = Military (10 years/10⁵cycles)

5962-94599 01 MX X

Lead Finish

- A = Solder DIP lead finish
- C = Gold lead DIP finish
- X = Lead finish "A" or "C" is acceptable

Package

- MX = Ceramic 28 pin 300-mil DIP
- MY = Ceramic 28 pin LCC

Access Time

- 01 = 55ns
- 02 = 45ns
- 03 = 35ns

Document Revision History

| Revision | Date | Summary |
|----------|----------------|--|
| 0.0 | December 2002 | Combined commercial, industrial and military datasheets. Removed 20 nsec device. |
| 0.1 | January 2003 | Added 35 nsec SMD to order information |
| 0.2 | July 2003 | Added "28 - SOIC" label to page 1 pinout drawing |
| 0.3 | September 2003 | Added lead-free lead finish |
| 0.4 | October 2003 | Restored "W" 600 mil DIP package to ordering information |
| | | |

