



## 32K × 8 ELECTRICALLY ERASABLE EPROM

### GENERAL DESCRIPTION

The W27E257 is a high-speed, low-power Electrically Erasable and Programmable Read Only Memory organized as 32768 × 8 bits that operates on a single 5 volt power supply. The W27E257 provides an electrical chip erase function. This part was the same EPROM Writer's utilities as the W27E256.

### FEATURES

- High speed access time: 100/120/150 nS (max.)
- Read operating current: 15 mA (typ.)
- Erase/Programming operating current 1 mA (typ.)
- Standby current: 5 μA (typ.)
- Single 5V power supply
- +14V erase/+12V programming voltage
- Fully static operation
- All inputs and outputs directly TTL/CMOS compatible
- Three-state outputs
- Available packages: 28-pin 600 mil DIP and 32-pin PLCC

### PIN CONFIGURATIONS

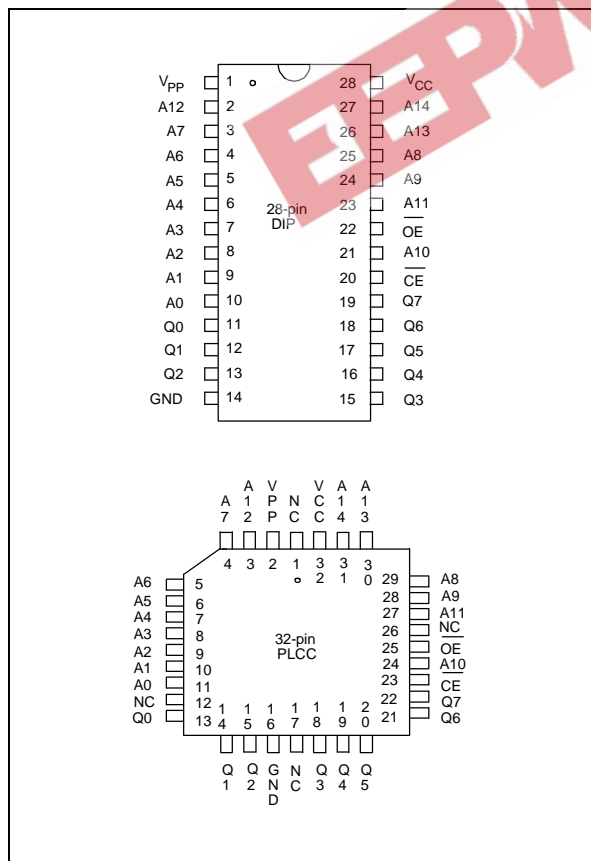

### BLOCK DIAGRAM

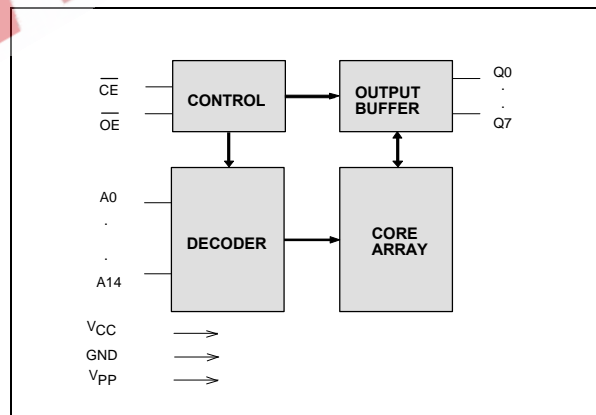

### PIN DESCRIPTION

SYMBOL	DESCRIPTION
A0–A14	Address Inputs
Q0–Q7	Data Inputs/Outputs
$\overline{CE}$	Chip Enable
$\overline{OE}$	Output Enable
VPP	Program/Erase Supply Voltage
VCC	Power Supply
GND	Ground
NC	No Connection



## FUNCTIONAL DESCRIPTION

### Read Mode

Like conventional UVEPROMs, the W27E257 has two control functions, both of which produce data at the outputs.

$\overline{CE}$  is for power control and chip select.  $\overline{OE}$  controls the output buffer to gate data to the output pins. When addresses are stable, the address access time ( $T_{ACC}$ ) is equal to the delay from  $\overline{CE}$  to output ( $T_{CE}$ ), and data are available at the outputs  $T_{OE}$  after the falling edge of  $\overline{OE}$ , if  $T_{ACC}$  and  $T_{CE}$  timings are met.

### Erase Mode

The erase operation is the only way to change data from "0" to "1." Unlike conventional UVEPROMs, which use ultraviolet light to erase the contents of the entire chip (a procedure that requires up to half an hour), the W27E257 uses electrical erasure. Generally, the chip can be erased within 100 mS by using an EPROM writer with a special erase algorithm.

Erase mode is entered when  $V_{PP}$  is raised to  $V_{PE}$  (14V),  $V_{CC} = V_{CE}$  (5V),  $\overline{OE} = V_{IH}$  (2V or above but lower than  $V_{CC}$ ),  $A_9 = V_{HH}$  (14V),  $A_0 = V_{IL}$  (0.8V or below but higher than GND), and all other address pins equal  $V_{IL}$  and data input pins equal  $V_{IH}$ . Pulsing  $\overline{CE}$  low starts the erase operation.

### Erase Verify Mode

After an erase operation, all of the bytes in the chip must be verified to check whether they have been successfully erased to "1" or not. The erase verify mode automatically ensures a substantial erase margin. This mode will be entered after the erase operation if  $V_{PP} = V_{PE}$  (14V),  $\overline{CE} = V_{IH}$ , and  $\overline{OE} = V_{IL}$ .

### Program Mode

Programming is performed exactly as it is in conventional UVEPROMs, and programming is the only way to change cell data from "1" to "0." The program mode is entered when  $V_{PP}$  is raised to  $V_{PP}$  (12V),  $V_{CC} = V_{CP}$  (5V),  $\overline{OE} = V_{IH}$ , the address pins equal the desired address, and the input pins equal the desired inputs. Pulsing  $\overline{CE}$  low starts the programming operation.

### Program Verify Mode

All of the bytes in the chip must be verified to check whether or not they have been successfully programmed with the desired data. Hence, after each byte is programmed, a program verify operation should be performed. The program verify mode automatically ensures a substantial program margin. This mode will be entered after the program operation if  $V_{PP} = V_{PP}$  (12V),  $\overline{CE} = V_{IH}$ , and  $\overline{OE} = V_{IL}$ .

### Erase/Program Inhibit

Erase or program inhibit mode allows parallel erasing or programming of multiple chips with different data. When  $\overline{CE} = V_{IH}$ , erasing or programming of non-target chips is inhibited, so that except for the  $\overline{CE}$  and  $\overline{OE}$  pins, the W27E257 may have common inputs.



## Standby Mode

The standby mode significantly reduces  $V_{CC}$  current. This mode is entered when  $\overline{CE} = V_{IH}$ . In standby mode, all outputs are in a high impedance state, independent of  $\overline{OE}$ .

## Two-line Output Control

Since EPROMs are often used in large memory arrays, the W27E257 provides two control inputs for multiple memory connections. Two-line control provides for lowest possible memory power dissipation and ensures that data bus contention will not occur.

## System Considerations

EPROM power switching characteristics require careful device decoupling. System designers are interested in three supply current issues: standby current levels ( $I_{SB}$ ), active current levels ( $I_{CC}$ ), and transient current peaks produced by the falling and rising edges of  $\overline{CE}$ . Transient current magnitudes depend on the device output's capacitive and inductive loading. Two-line control and proper decoupling capacitor selection will suppress transient voltage peaks. Each device should have a  $0.1 \mu\text{F}$  ceramic capacitor connected between its  $V_{CC}$  and  $GND$ . This high frequency, low inherent-inductance capacitor should be placed as close as possible to the device. Additionally, for every eight devices, a  $4.7 \mu\text{F}$  electrolytic capacitor should be placed at the array's power supply connection between  $V_{CC}$  and  $GND$ . The bulk capacitor will overcome voltage slumps caused by PC board trace inductances.

## TABLE OF OPERATING MODES

( $V_{PP} = 12\text{V}$ ,  $V_{PE} = 14\text{V}$ ,  $V_{HH} = 12\text{V}$ ,  $V_{CP} = 5\text{V}$ ,  $X = V_{IH}$  or  $V_{IL}$ )

MODE	PINS						
	$\overline{CE}$	$\overline{OE}$	A0	A9	VCC	VPP	OUTPUTS
Read	VIL	VIL	X	X	VCC	VCC	DOUT
Output Disable	VIL	VIH	X	X	VCC	VCC	High Z
Standby (TTL)	VIH	X	X	X	VCC	VCC	High Z
Standby (CMOS)	$V_{CC} \pm 0.3\text{V}$	X	X	X	VCC	VCC	High Z
Program	VIL	VIH	X	X	VCP	VPP	DIN
Program Verify	VIH	VIL	X	X	VCP	VPP	DOUT
Program Inhibit	VIH	VIH	X	X	VCP	VPP	High Z
Erase	VIL	VIH	VIL	VPE	VCC	VPE	DIH
Erase Verify	VIH	VIL	X	X	VCC	VPE	DOUT
Erase Inhibit	VIH	VIH	X	X	VCP	VPP	High Z
Product Identifier-manufacturer	VIL	VIL	VIL	VHH	VCC	VCC	DA (Hex)
Product Identifier-device	VIL	VIL	VIH	VHH	VCC	VCC	02 (Hex)



## DC CHARACTERISTICS

### Absolute Maximum Ratings

PARAMETER	RATING	UNIT
Ambient Temperature with Power Applied	-55 to +125	°C
Storage Temperature	-65 to +125	°C
Voltage on all pins with Respect to Ground Except V <sub>PP</sub> , A9 and V <sub>CC</sub> pins	-0.5 to V <sub>CC</sub> +0.5	V
Voltage on V <sub>PP</sub> Pin with Respect to Ground	-0.5 to +14.5	V
Voltage on A9 Pin with Respect to Ground	-0.5 to +14.5	V
Voltage on V <sub>CC</sub> Pin with Respect to Ground	-0.5 to +7	V

Note: Exposure to conditions beyond those listed under Absolute Maximum Ratings may adversely affect the life and reliability of the device.

### DC Erase Characteristics

(T<sub>A</sub> = 25° C ±5° C, V<sub>CC</sub> = 5.0V ±10%)

PARAMETER	SYM.	CONDITIONS	LIMITS			UNIT
			MIN.	TYP.	MAX.	
Input Load Current	I <sub>LI</sub>	V <sub>IN</sub> = V <sub>IL</sub> or V <sub>IH</sub>	-10	-	10	μA
V <sub>CC</sub> Erase Current	I <sub>CP</sub>	$\overline{CE}$ = V <sub>IL</sub>	-	-	30	mA
V <sub>PP</sub> Erase Current	I <sub>PP</sub>	$\overline{CE}$ = V <sub>IL</sub>	-	-	30	mA
Input Low Voltage	V <sub>IL</sub>	-	-0.3	-	0.8	V
Input High Voltage	V <sub>IH</sub>	-	2.4	-	5.5	V
Output Low Voltage (Verify)	V <sub>OL</sub>	I <sub>OL</sub> = 2.1 mA	-	-	0.45	V
Output High Voltage (Verify)	V <sub>OH</sub>	I <sub>OH</sub> = -0.4 mA	2.4	-	-	-
A9 Erase Voltage	V <sub>ID</sub>	-	13.75	14	14.25	V
V <sub>PP</sub> Erase Voltage	V <sub>PE</sub>	-	13.75	14	14.25	V
V <sub>CC</sub> Supply Voltage (Erase)	V <sub>CE</sub>	-	4.5	5.0	5.5	V

Note: V<sub>CC</sub> must be applied simultaneously or before V<sub>PP</sub> and removed simultaneously or after V<sub>PP</sub>.

### CAPACITANCE

(V<sub>CC</sub> = 5V, T<sub>A</sub> = 25° C, f = 1 MHz)

PARAMETER	SYMBOL	CONDITIONS	MAX.	UNIT
Input Capacitance	C <sub>IN</sub>	V <sub>IN</sub> = 0V	6	pF
Output Capacitance	C <sub>OUT</sub>	V <sub>OUT</sub> = 0V	12	pF



**AC CHARACTERISTICS**

**AC Test Conditions**

PARAMETER	CONDITIONS
Input Pulse Levels	0.45V to 2.4V
Input Rise and Fall Times	10 nS
Input and Output Timing Reference Level	0.8V/2.0V
Output Load	CL = 100 pF, IOH/IO L = -0.4 mA/2.1 mA

**AC Test Load and Waveform**

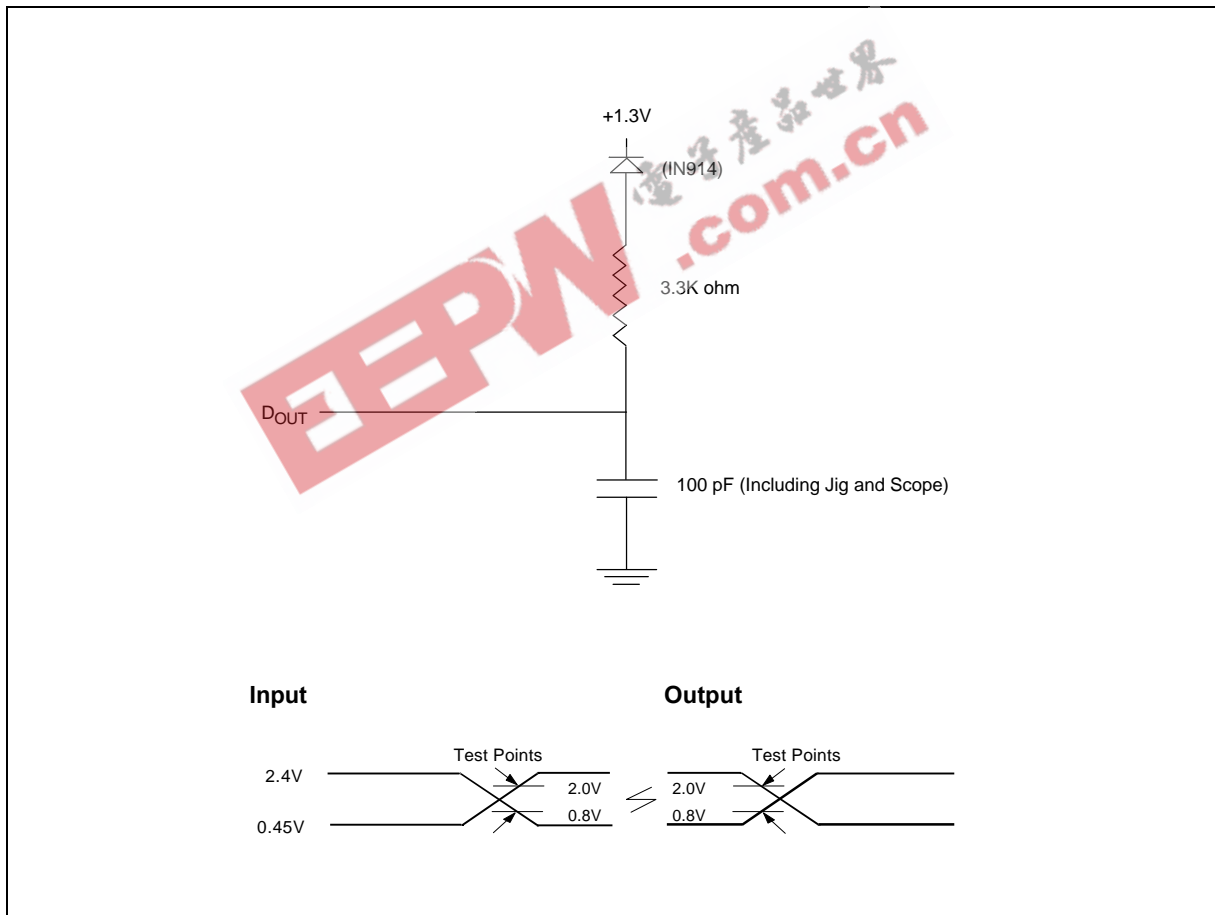



## READ OPERATION DC CHARACTERISTICS

(V<sub>CC</sub> = 5.0V ±10%, T<sub>A</sub> = 0 to 70° C)

(W27E257-10, S-10, K-10, P-10: V<sub>CC</sub>, min. = 3.0V and max. = 5.5V)

PARAMETER	SYM.	CONDITIONS	LIMITS			UNIT
			MIN.	TYP.	MAX.	
Input Load Current	I <sub>LI</sub>	V <sub>IN</sub> = 0V to V <sub>CC</sub>	-5	-	5	μA
Output Leakage Current	I <sub>LO</sub>	V <sub>OUT</sub> = 0V to V <sub>CC</sub>	-10	-	10	μA
V <sub>CC</sub> Standby Current	I <sub>SB</sub>	$\overline{CE} = V_{IH}$	-	-	1.0	mA
	I <sub>SB1</sub>	$\overline{CE} = V_{CC} \pm 0.2V$	-	5	100	μA
V <sub>CC</sub> Operating Current	I <sub>CC</sub>	$\overline{CE} = V_{IL}$ I <sub>OUT</sub> = 0 mA f = 5 MHz	-	-	30	mA
V <sub>PP</sub> Operating Current	I <sub>PP</sub>	V <sub>PP</sub> = V <sub>CC</sub>	-	-	100	μA
Input Low Voltage	V <sub>IL</sub>	-	-0.3	-	0.8	V
Input High Voltage	V <sub>IH</sub>	-	2.0	-	V <sub>CC</sub> + 0.5	V
Output Low Voltage	V <sub>OL</sub>	I <sub>OL</sub> = 2.1 mA	-	-	0.45	V
Output High Voltage	V <sub>OH</sub>	I <sub>OH</sub> = -0.4 mA	2.4	-	-	V
V <sub>PP</sub> Operating Voltage	V <sub>PP</sub>	-	V <sub>CC</sub> - 0.7	-	V <sub>CC</sub>	V

## READ OPERATION AC CHARACTERISTICS

(V<sub>CC</sub> = 5.0V ±10%, T<sub>A</sub> = 0 to 70° C)

PARAMETER	SYM.	W27E257-10		W27E257-12		W27E257-15		UNIT
		MIN.	MAX.	MIN.	MAX.	MIN.	MAX.	
Read Cycle Time	TRC	100	-	120	-	150	-	nS
Chip Enable Access Time	T <sub>CE</sub>	-	100	-	120	-	150	nS
Address Access Time	T <sub>ACC</sub>	-	100	-	120	-	150	nS
Output Enable Access Time	T <sub>OE</sub>	-	50	-	60	-	70	nS
$\overline{OE}$ High to High-Z Output	T <sub>DF</sub>	-	30	-	30	-	50	nS
Output Hold from Address Change	T <sub>OH</sub>	0	-	0	-	0	-	nS

Note: V<sub>CC</sub> must be applied simultaneously or before V<sub>PP</sub> and removed simultaneously or after V<sub>PP</sub>.



## DC PROGRAMMING CHARACTERISTICS

(V<sub>CC</sub> = 5.0V ±10%, T<sub>A</sub> = 25° C ±5° C)

PARAMETER	SYM.	CONDITIONS	LIMITS			UNIT
			MIN.	TYP.	MAX.	
Input Load Current	I <sub>LI</sub>	V <sub>IN</sub> = V <sub>IL</sub> or V <sub>IH</sub>	-10	-	10	μA
V <sub>CC</sub> Program Current	I <sub>CP</sub>	$\overline{CE} = V_{IL}$	-	-	30	mA
V <sub>PP</sub> Program Current	I <sub>PP</sub>	$\overline{CE} = V_{IL}$	-	-	30	mA
Input Low Voltage	V <sub>IL</sub>	-	-0.3	-	0.8	V
Input High Voltage	V <sub>IH</sub>	-	2.4	-	5.5	V
Output Low Voltage (Verify)	V <sub>OL</sub>	I <sub>OL</sub> = 2.1 mA	-	-	0.45	V
Output High Voltage (Verify)	V <sub>OH</sub>	I <sub>OH</sub> = -0.4 mA	2.4	-	-	V
A9 Silicon I.D. Voltage	V <sub>ID</sub>	-	11.5	12.0	12.5	V
V <sub>PP</sub> Program Voltage	V <sub>PP</sub>	-	11.75	12.0	12.25	V
V <sub>CC</sub> Supply Voltage (Program)	V <sub>CP</sub>	-	4.5	5.0	5.5	V

## AC PROGRAMMING/ERASE CHARACTERISTICS

(V<sub>CC</sub> = 5.0V ±10%, T<sub>A</sub> = 25° C ±5° C)

PARAMETER	SYM.	LIMITS			UNIT
		MIN.	TYP.	MAX.	
V <sub>PP</sub> Setup Time	T <sub>VPS</sub>	2.0	-	-	μS
Address Setup Time	T <sub>AS</sub>	2.0	-	-	μS
Data Setup Time	T <sub>DS</sub>	2.0	-	-	μS
$\overline{CE}$ Program Pulse Width	T <sub>PWP</sub>	95	100	105	μS
$\overline{CE}$ Erase Pulse Width	T <sub>PWE</sub>	95	100	105	mS
Data Hold Time	T <sub>DH</sub>	2.0	-	-	μS
$\overline{OE}$ Setup Time	T <sub>OES</sub>	2.0	-	-	μS
Data Valid from $\overline{OE}$	T <sub>OEV</sub>	-	-	150	nS
$\overline{OE}$ High to Output High Z	T <sub>DFP</sub>	0	-	130	nS
Address Hold Time	T <sub>AH</sub>	0	-	-	μS
Address Hold Time after $\overline{CE}$ High (Erase)	T <sub>AHC</sub>	2.0	-	-	μS

Note: V<sub>CC</sub> must be applied simultaneously or before V<sub>PP</sub> and removed simultaneously or after V<sub>PP</sub>.



**TIMING WAVEFORMS**

**AC Read Waveform**

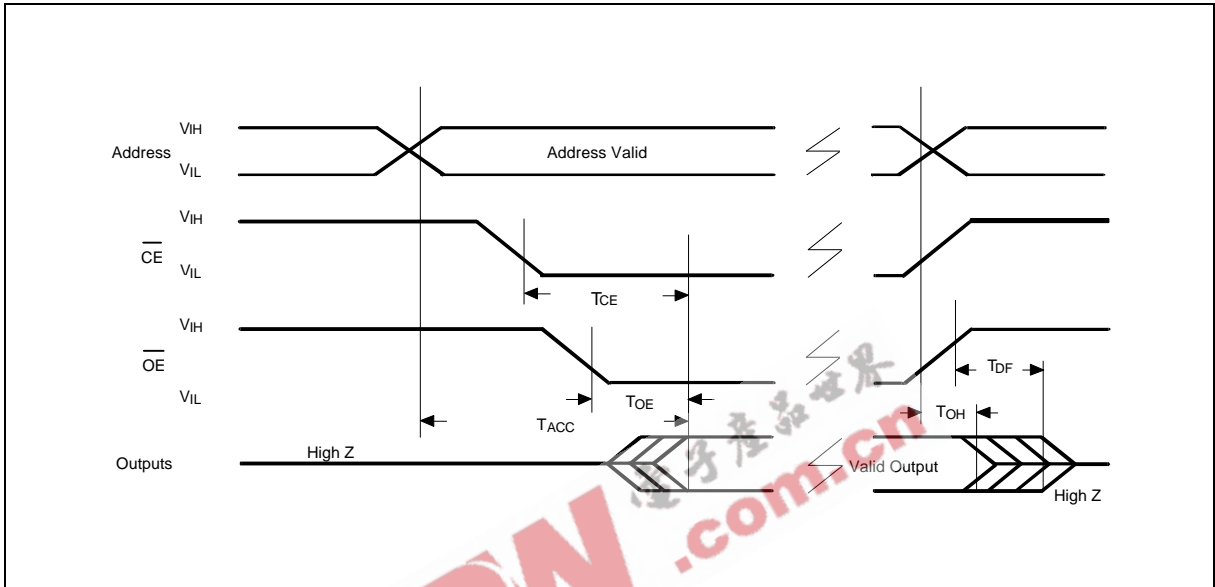

**Erase Waveform**

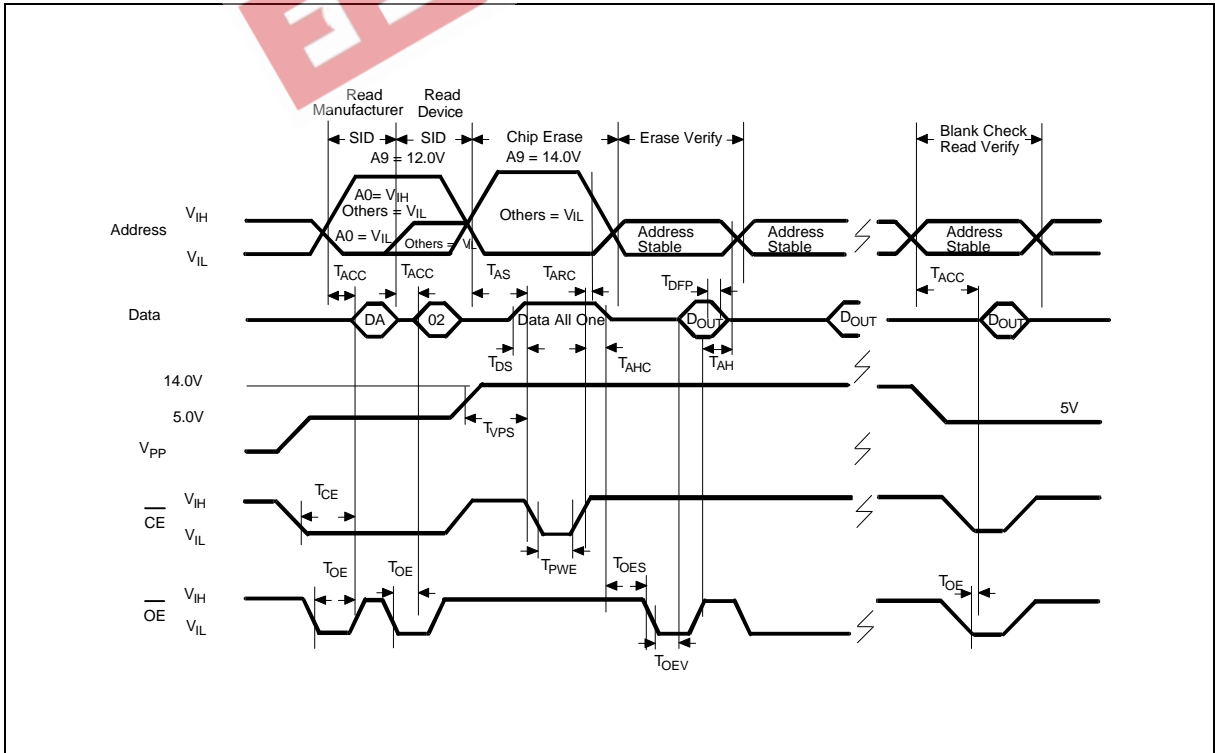





Timing Waveforms, continued

**Programming Waveform**

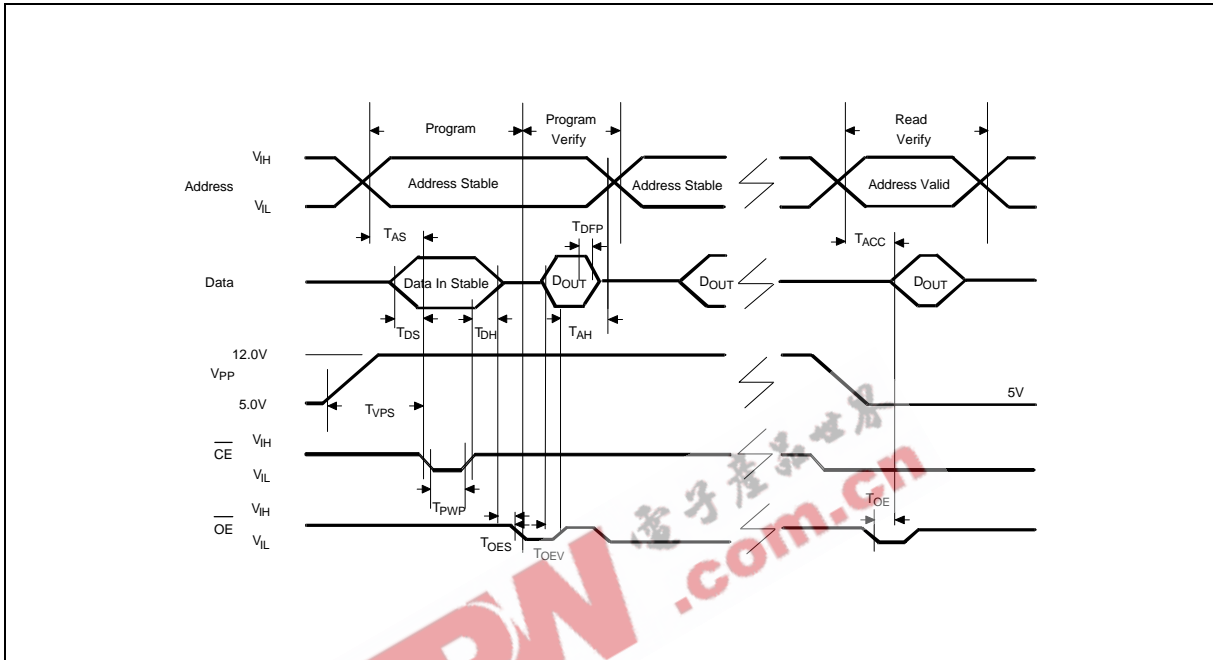

EEPW.com.cn

SMART PROGRAMMING ALGORITHM

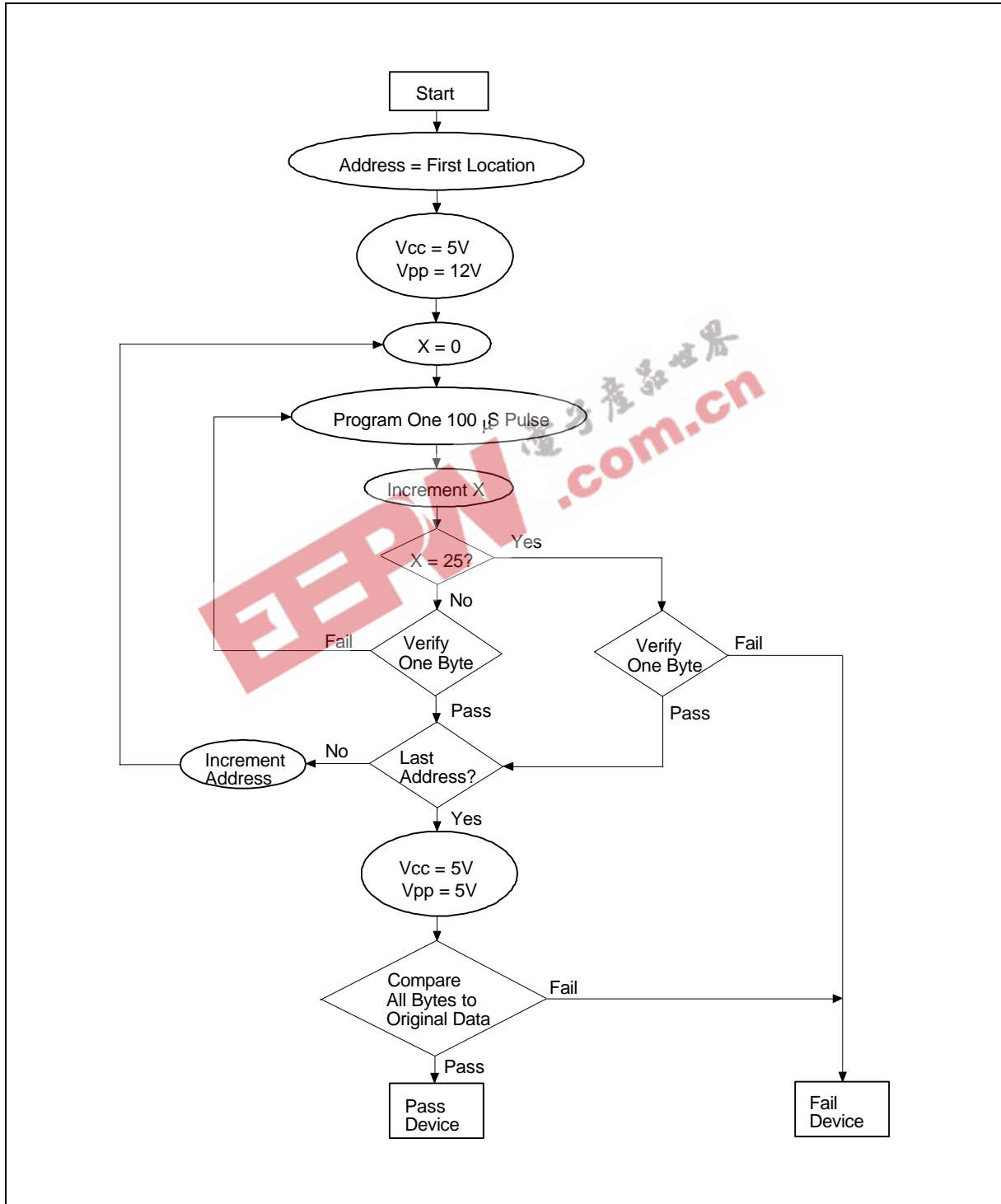



SMART ERASE ALGORITHM

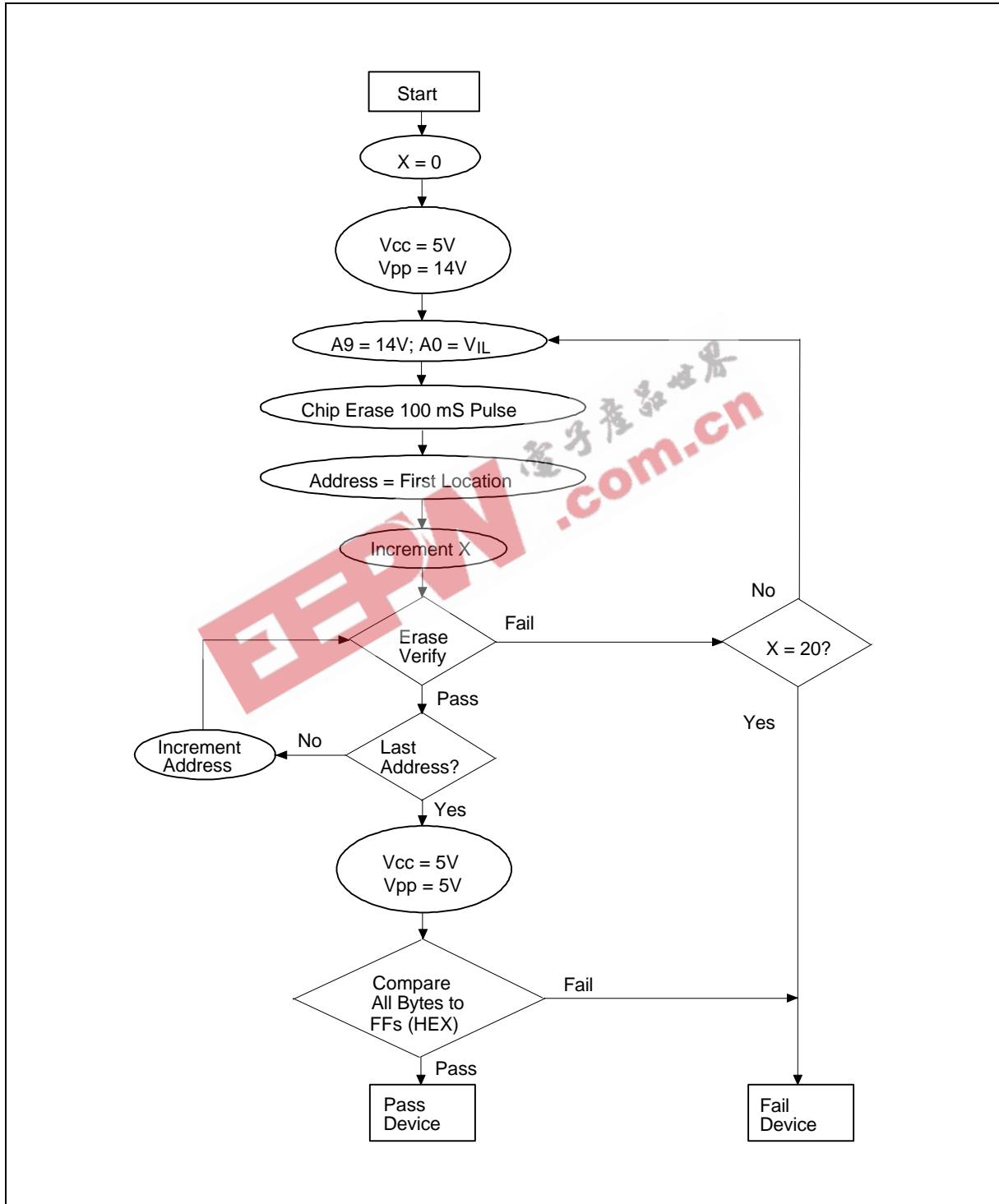

**ORDERING INFORMATION**

<b>PART NO.</b>	<b>ACCESS TIME (nS)</b>	<b>POWER SUPPLY CURRENT MAX. (mA)</b>	<b>STANDBY V<sub>CC</sub> CURRENT MAX. (μA)</b>	<b>PACKAGE</b>
W27E257-10	100	30	100	600 mil DIP
W27E257-12	120	30	100	600 mil DIP
W27E257-15	150	30	100	600 mil DIP
W27E257P-10	100	30	100	32-pin PLCC
W27E257P-12	120	30	100	32-pin PLCC
W27E257P-15	150	30	100	32-pin PLCC

## Notes:

1. Winbond reserves the right to make changes to its products without prior notice.
2. Purchasers are responsible for performing appropriate quality assurance testing on products intended for use in applications where personal injury might occur as a consequence of product failure.



PACKAGE DIMENSIONS

28-pin P-DIP

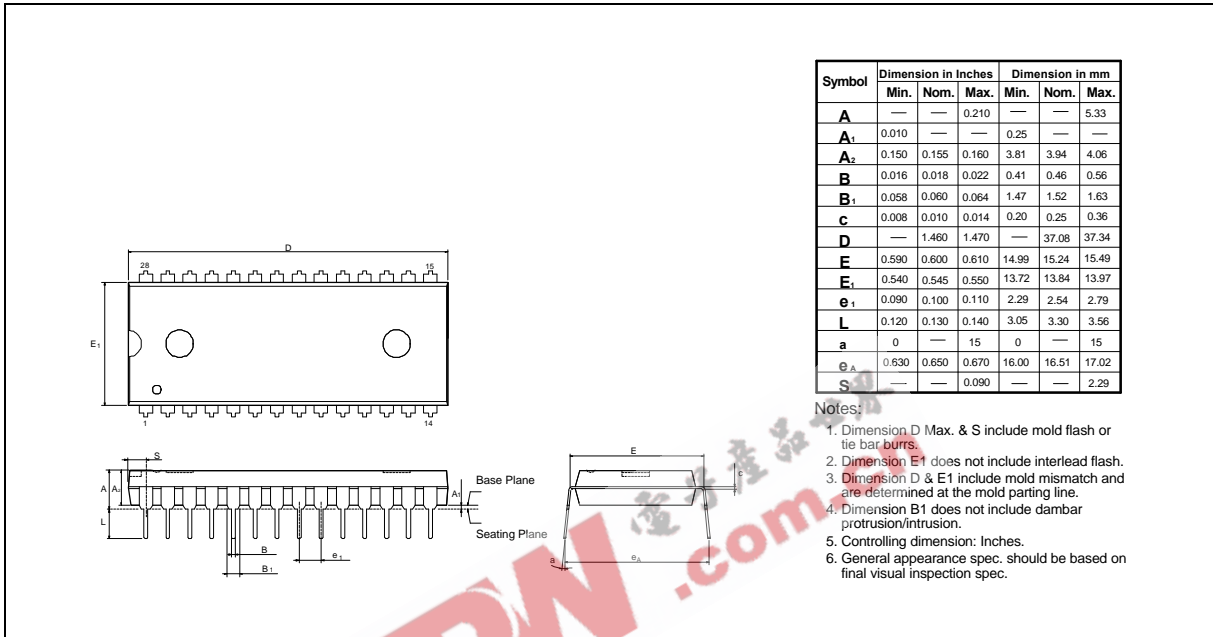

32-pin PLCC

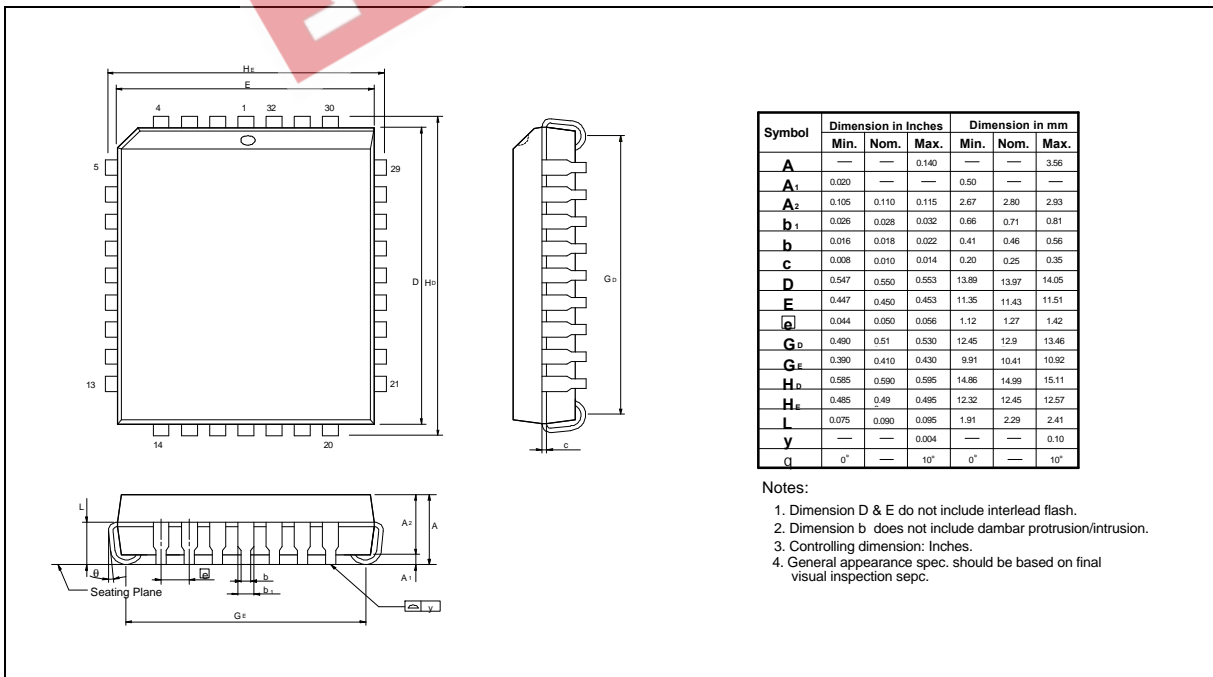



EEPW 电子產品世界  
.com.cn



**Headquarters**

No. 4, Creation Rd. III,  
Science-Based Industrial Park,  
Hsinchu, Taiwan  
TEL: 886-3-5770066  
FAX: 886-3-5792647  
<http://www.winbond.com.tw/>  
Voice & Fax-on-demand: 886-2-7197006

**Taipei Office**

11F, No. 115, Sec. 3, Min-Sheng East Rd.,  
Taipei, Taiwan  
TEL: 886-2-7190505  
FAX: 886-2-7197502

**Winbond Electronics (H.K.) Ltd.**

Rm. 803, World Trade Square, Tower II,  
123 Hoi Bun Rd., Kwun Tong,  
Kowloon, Hong Kong  
TEL: 852-27513100  
FAX: 852-27552064

**Winbond Electronics North America Corp.**

**Winbond Memory Lab.**  
**Winbond Microelectronics Corp.**  
**Winbond Systems Lab.**  
2730 Orchard Parkway, San Jose,  
CA 95134, U.S.A.  
TEL: 1-408-9436666  
FAX: 1-408-9436668

Note: All data and specifications are subject to change without notice.