



FEATURES

- 8-bit voltage output DAC
- Single supply from 2.7V to 5.5V
- Very low power consumption (3V supply):
 - 900µW, slow mode
 - 2.1mW, fast mode
 - 3µW, standby mode
- DNL ±0.2 LSB, INL ±0.5 LSB (max)
- Monotonic over Temperature
- DSP compatible serial interface
- Programmable settling time of 3µs or 9µs typical
- High impedance reference input buffer

APPLICATIONS

- Digital Servo Control Loops
- Industrial Process Control
- Battery powered instruments and controls
- Machine and motion control devices
- Digital offset and gain adjustment

ORDERING INFORMATION

DEVICE	TEMP. RANGE	PACKAGE
WM2623CD	0° to 70°C	8-pin SOIC
WM2623ID	-40° to 85°C	8-pin SOIC

DESCRIPTION

The WM2623 is an 8-bit voltage output, resistor string digital-to-analogue converter. It can operate with supply voltages between 2.7V and 5.5V and can be powered down under software control. Power down reduces current consumption to less than 1 µA.

The device has been designed for glueless interface to industry standard microprocessors and DSPs, including the TMS320 family. The WM2623 is programmed with a 16-bit serial word including 4 control bits and 8 data bits.

Excellent performance is delivered with a typical DNL of 0.2LSBs. Monotonicity is guaranteed over the operating temperature range. The settling time of the DAC is programmable to allow for optimisation of speed versus power dissipation. The output stage is buffered by a rail-to-rail amplifier with a gain of two, which features a Class AB output stage.

The reference voltage input features a high impedance buffer which eliminates the need to keep the reference source impedance low.

The WM2623 is available in an 8-pin SOIC package. Commercial (0° to 70°C) and Industrial (-40° to 85°C) temperature range variants are available.

BLOCK DIAGRAM

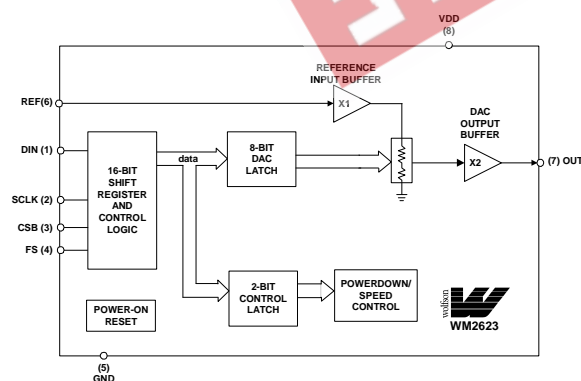

TYPICAL PERFORMANCE

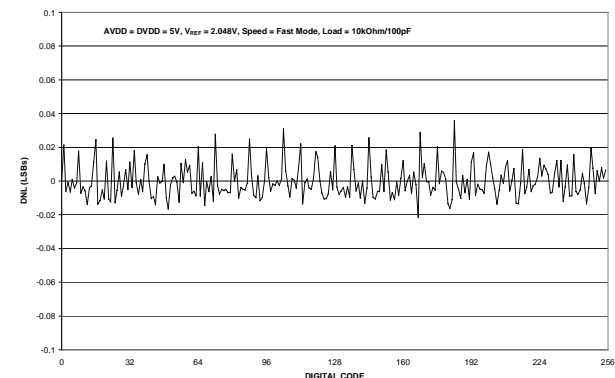

PIN CONFIGURATION

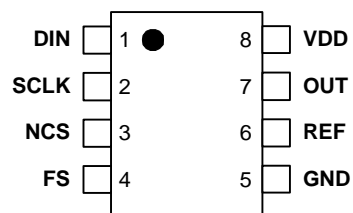

PIN DESCRIPTION

PIN NO	NAME	TYPE	DESCRIPTION
1	DIN	Digital input	Serial data input
2	SCLK	Digital input	Serial clock input
3	NCS	Digital input	Chip select. This pin is active low.
4	FS	Digital input	Frame synchronisation for serial input data
5	GND	Supply	Ground
6	REF	Analogue input	Voltage reference input
7	OUT	Analogue output	DAC analogue output
8	VDD	Supply	Positive power supply

ABSOLUTE MAXIMUM RATINGS

Absolute Maximum Ratings are stress ratings only. Permanent damage to the device may be caused by continuously operating at or beyond these limits. Device functional operating limits and guaranteed performance specifications are given under Electrical Characteristics at the test conditions specified.



ESD Sensitive Device. This device is manufactured on a CMOS process. It is therefore generically susceptible to damage from excessive static voltages. Proper ESD precautions must be taken during handling and storage of this device.

CONDITION	MIN	MAX
Supply voltage, VDD to GND		7V
Digital input voltage	-0.3V	VDD + 0.3V
Reference input voltage	-0.3V	VDD + 0.3V
Operating temperature range, T _A	WM2623CD	0°C
	WM2623ID	70°C
Storage temperature	-40°C	85°C
Storage temperature	-65°C	150°C
Lead temperature 1.6mm (1/16 inch) from package body for 10 seconds		260°C

RECOMMENDED OPERATING CONDITIONS

PARAMETER	SYMBOL	TEST CONDITIONS	MIN	TYP	MAX	UNIT
Supply voltage	VDD		2.7		5.5	V
High-level digital input voltage	V _{IH}	VDD = 2.7V to 5.5V	2			V
Low-level digital input voltage	V _{IL}	VDD = 2.7V to 5.5V			0.8	V
Reference voltage to REF pin	V _{REF}	See Note	AGND		VDD - 1.5	V
Load resistance	R _L		2	10		kΩ
Load capacitance	C _L				100	pF
Serial clock frequency	f _{SCLK}				20	MHz
Operating free-air temperature	T _A	WM2623CD	0		70	°C
		WM2623ID	-40		85	°C

Note:

Reference input voltages greater than VDD/2 will cause clipping for large DAC codes.

ELECTRICAL CHARACTERISTICS

Test Conditions:

$R_L = 10k\Omega$, $C_L = 100pF$. $V_{DD} = 5V \pm 10\%$, $V_{REF} = 2.048V$ and $V_{DD} = 3V \pm 10\%$, $V_{REF} = 1.024V$ over recommended operating free-air temperature range (unless noted otherwise).

PARAMETER	SYMBOL	TEST CONDITIONS	MIN	TYP	MAX	UNIT
Static DAC Specifications						
Resolution			8			bits
Integral non-linearity	INL	See Note 1		± 0.3	± 0.5	LSB
Differential non-linearity	DNL	See Note 2		± 0.07	± 0.2	LSB
Zero code error	ZCE	See Note 3			± 10	mV
Gain error	GE	See Note 4			± 0.6	% FSR
D.C. power supply rejection ratio	PSRR	See Note 5		- 68		dB
Zero code error temperature coefficient		See Note 6		10		ppm/ $^{\circ}C$
Gain error temperature coefficient		See Note 6		10		ppm/ $^{\circ}C$
DAC Output Specifications						
Output voltage range			0		$V_{DD} - 0.1$	V
Output load regulation		2k Ω to 10k Ω load See Note 7		0.1	0.25	% FS
Power Supplies						
		No load, DAC value = 128, all digital inputs 0V or VDD				
Active supply current	I_{DD}	VDD = 5V, $V_{REF} = 2.048V$ Slow Mode		0.4	0.6	mA
		VDD = 5V, $V_{REF} = 2.048V$ Fast Mode		0.9	1.35	mA
		VDD = 3V, $V_{REF} = 1.024V$, Slow Mode		0.3	0.45	mA
		VDD = 3V, $V_{REF} = 1.024V$, Fast Mode (See Note 8)		0.7	1.1	mA
Power down supply current				1		μA
Dynamic DAC Specifications						
Slew rate	SR	DAC output 10%-90% Slow Fast See Note 9		0.9 3.6		V/ μs V/ μs
Settling time	t_s	DAC output 10%-90% Slow Fast See Note 10		9 3	20 5.5	μs μs
Glitch energy		DAC Code 127 to 128		10		nV-s
Signal to noise ratio	SNR	$f_s = 400kSPS$, $f_{OUT} = 1.1kHz$, BW = 20kHz See Note 11		57		dB
Signal to noise and distortion ratio	SNRD			49		dB
Total harmonic distortion	THD			-50		dB
Spurious free dynamic range	SPFDR			60		dB
Reference						
Reference input resistance	R_{REFIN}			10		M Ω
Reference input capacitance	C_{REFIN}			5		pF
Reference feedthrough		$V_{REF} = 1V_{PP}$ at 1kHz + 1.024V dc, DAC code 0		-75		dB
Reference input bandwidth		$V_{REF} = 0.2V_{PP} + 1.024V$ dc DAC code 128 Slow Fast		0.525		MHz
				1.3		MHz

Test Conditions:

$R_L = 10k\Omega$, $C_L = 100pF$. $V_{DD} = 5V \pm 10\%$, $V_{REF} = 2.048V$ and $V_{DD} = 3V \pm 10\%$, $V_{REF} = 1.024V$ over recommended operating free-air temperature range (unless noted otherwise).

PARAMETER	SYMBOL	TEST CONDITIONS	MIN	TYP	MAX	UNIT
Digital Inputs						
High level input current	I_{IH}	Input voltage = VDD			1	μA
Low level input current	I_{IL}	Input voltage = 0V			-1	μA
Input capacitance	C_i			3		pF

Notes:

- Integral non-linearity (INL)** is the maximum deviation of the output from the line between zero and full scale (excluding the effects of zero code and full scale errors).
- Differential non-linearity (DNL)** is the difference between the measured and ideal 1LSB amplitude change of any adjacent two codes. A guarantee of monotonicity means the output voltage always changes in the same direction (or remains constant) as the digital input code.
- Zero code error** is the voltage output when the DAC input code is zero.
- Gain error** is the deviation from the ideal full scale output excluding the effects of zero code error.
- Power supply rejection ratio** is measured by varying VDD from 4.5V to 5.5V and measuring the proportion of this signal imposed on the zero code error and the gain error.
- Zero code error** and **Gain error** temperature coefficients are normalised to full scale voltage.
- Output load regulation** is the difference between the output voltage at full scale with a 10k Ω load and 2k Ω load. It is expressed as a percentage of the full scale output voltage with a 10k Ω load.
- I_{DD} is measured while continuously writing code 128 to the DAC. For $V_{IH} < V_{DD} - 0.7V$ and $V_{IL} > 0.7V$ supply current will increase.
- Slew rate** results are for the lower value of the rising and falling edge slew rates.
- Settling time** is the time taken for the signal to settle to within 0.5LSB of the final measured value for both rising and falling edges. Limits are ensured by design and characterisation, but are not production tested.
- SNR**, **SNRD**, **THD** and **SPFDR** are measured on a synthesised sinewave at frequency f_{OUT} generated with a sampling frequency f_s .

SERIAL INTERFACE

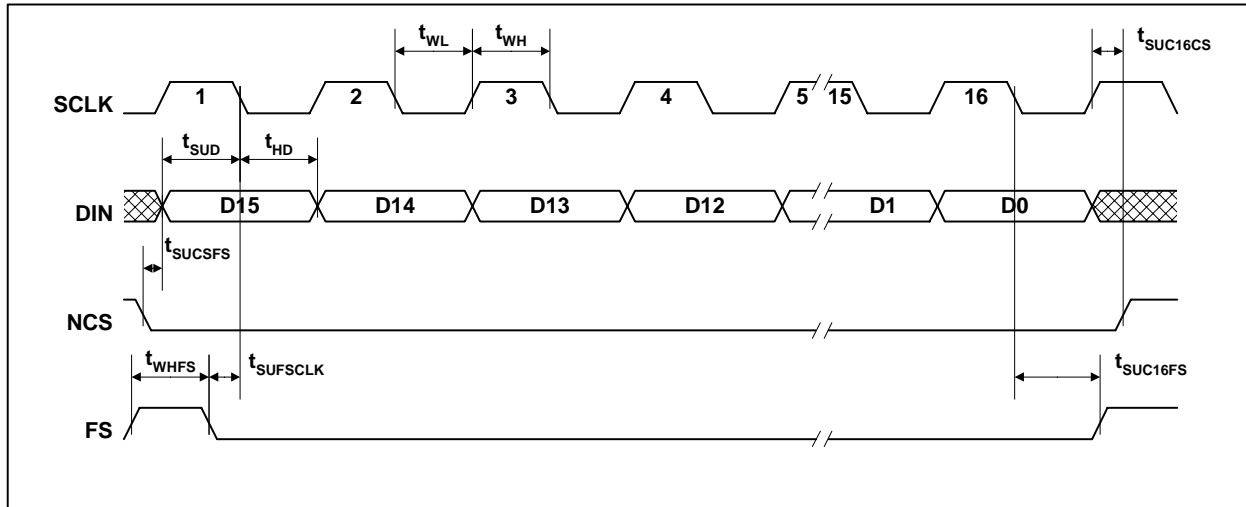

Figure 1 Timing Diagram

Test Conditions:

$R_L = 10k\Omega$, $C_L = 100pF$. $V_{DD} = 5V \pm 10\%$, $V_{REF} = 2.048V$ and $V_{DD} = 3V \pm 10\%$, $V_{REF} = 1.024V$ over recommended operating free-air temperature range (unless noted otherwise).

SYMBOL	TEST CONDITIONS	MIN	TYP	MAX	UNIT
t_{SUCSFS}	Setup time NCS low before falling FS edge.	10			ns
$t_{SUF SCLK}$	Setup time FS low before first falling SCLK edge.	8			ns
$t_{SUC16FS}$	Setup time, 16 th falling SCLK edge after FS low on which data bit D0 is sampled before rising edge of FS.	10			ns
$t_{SUC16CS}$	Setup time, 16 th rising SCLK edge (first after data bit D0 sampled) before NCS rising edge. If FS is used instead of the 16 th rising edge to update the DAC, this setup time is between the FS rising edge and the NCS rising edge.	10			ns
t_{WH}	Pulse duration, SCLK high.	25			ns
t_{WL}	Pulse duration, SCLK low.	25			ns
t_{SUD}	Setup time, data ready before SCLK falling edge.	8			ns
t_{HD}	Hold time, data held valid after SCLK falling edge.	5			ns
t_{WHFS}	Pulse duration, FS high.	20			ns

TYPICAL PERFORMANCE GRAPHS

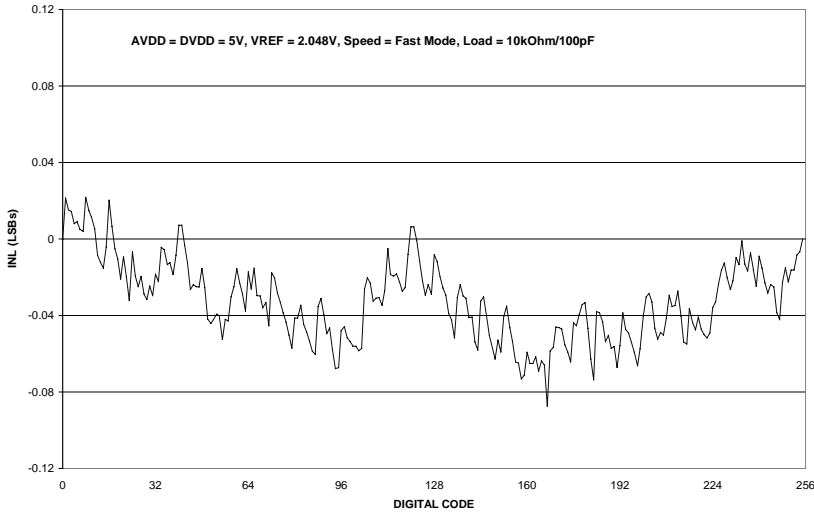

Figure 2 Integral Non-Linearity

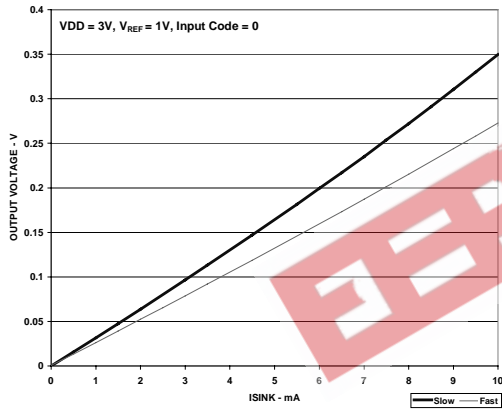

Figure 3 Sink Current VDD = 3V

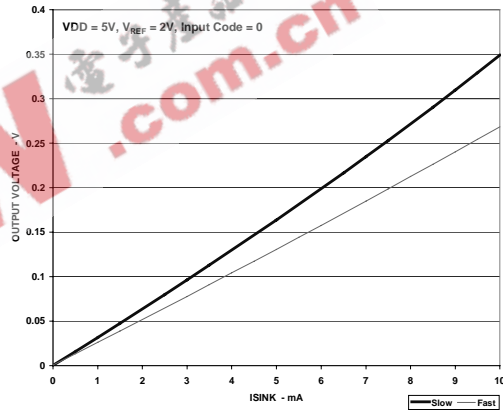

Figure 4 Sink Current VDD = 5V

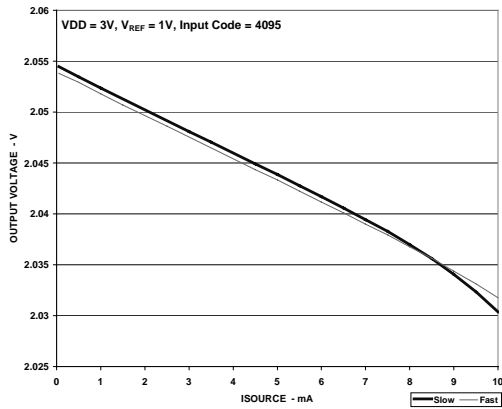

Figure 5 Source Current VDD = 3V

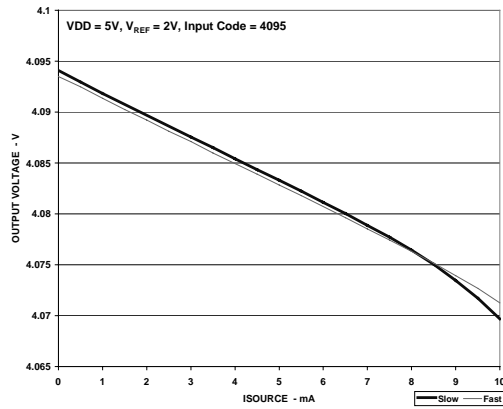

Figure 6 Source Current VDD = 5V

DEVICE DESCRIPTION

GENERAL FUNCTION

The WM2623 is an 8-bit, voltage output DAC operating from a single supply. The device uses a resistor string network buffered with an op amp to convert 8-bit digital data to analogue voltage levels (see Block Diagram). The output voltage is determined by the reference input voltage and the input code according to the following relationship:

$$V_{OUT} = 2(V_{REFIN}) \frac{CODE}{256}$$

INPUT		OUTPUT
1111	1111	$2(V_{REF}) \frac{255}{256}$
:	:	:
1000	0001	$2(V_{REF}) \frac{129}{256}$
1000	0000	$2(V_{REF}) \frac{128}{256} = V_{REF}$
0111	1111	$2(V_{REF}) \frac{127}{256}$
:	:	:
0000	0001	$2(V_{REF}) \frac{1}{256}$
0000	0000	0V

Table 1 Binary Code Table (0V to 2V_{REF7} Output), Gain = 2

POWER ON RESET

An internal power-on-reset circuit resets the DAC register to all 0s on power-up.

BUFFER AMPLIFIER

The output buffer has a near rail-to-rail output with short circuit protection and can reliably drive a 2kΩ load with a 100pF load capacitance.

EXTERNAL REFERENCE

The reference voltage input is buffered which makes the DAC input resistance independent of code. The REF pin has an input resistance of 10MΩ and an input capacitance of typically 5pF. The reference voltage determines the DAC full-scale output.

SERIAL INTERFACE

Before writing any data to the WM2623, the device must first be enabled by setting CSB to low. Then, a falling edge of FS starts shifting the data bit-per-bit (starting with the MSB) into the internal register on the falling edges of SCLK. After 16 bits have been transferred, the next rising edge on SCLK or FS causes the content of the shift register to be moved to the DAC latch which updates the voltage output to the new level.

The serial interface of the device can be used in two basic modes:

- four wire (with chip select)
- three wire (without chip select)

Using the chip select pin CSB (four wire mode), it is possible to have more than one device connected to the serial port of the data source (DSP or microcontroller). If there is no need to have more than one device on the serial bus, CSB can be tied low.

SERIAL CLOCK AND UPDATE RATE

Figure 1 shows the device timing. The maximum serial clock rate is:

$$f_{SCLK\ max} = \frac{1}{t_{WH\ min} + t_{WL\ min}} = 20MHz$$

Since a data word contains 16 bits, the sample rate is limited to

$$f_{s\ max} = \frac{1}{16(t_{WH\ min} + t_{WL\ min})} = 1.25MHz$$

However, the DAC settling time to 8 bits accuracy limits the response time of the analogue output for large input step transitions.

SOFTWARE CONFIGURATION OPTIONS

Table 2 shows the composition of a 16 bit data word. D11-D4 contains the 8-bit data word, and D14-D13 hold the programmable options. Bits D15, D12, and D3 through D0 should be set to ZERO.

D15	D14	D13	D12	D11	D10	D9	D8	D7	D6	D5	D4	D3	D2	D1	D0
0	SPD	PWR	0	New DAC value (8 bits)								0	0	0	0

Table 2 Register Map

PROGRAMMABLE SETTling TIME

SPD (Bit 14) allows for software control of the converter speed. A ONE selects the fast mode, where typical settling time to within $\pm 0.5LSB$ of the final value is 3 μs . a ZERO puts the device into the slow mode, where typical settling time is 9 μs .

PROGRAMMABLE POWER DOWN

The power down function is controlled by PWR (Bit 13). A ZERO configures the device as active, or fully powered up, a ONE configures the device into power down mode. When the power down function is released the device reverts to the DAC code set prior to power down.

APPLICATIONS INFORMATION

LINEARITY, OFFSET, AND GAIN ERROR

Amplifiers operating from a single supply can have positive or negative voltage offsets. With a positive offset, the output voltage changes on the first code transition. However, if the offset is negative, the output voltage may not change with the first code, depending on the magnitude of the offset voltage. This is because with the most negative supply rail being ground, any attempt to drive the output amplifier below ground will clamp the output at 0 V. The output voltage then remains at zero until the input code is sufficiently high to overcome the negative offset voltage, resulting in the transfer function shown in Figure 7. <file negative_offset.emf, below>

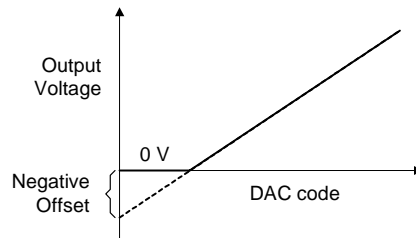

Figure 7 Effect of Negative Offset

This offset error, not the linearity error, produces the breakpoint. The transfer function would follow the dotted line if the output buffer could drive below the ground rail.

DAC linearity is measured between zero-input code (all input bits at 0) and full-scale code (all inputs at 1), disregarding offset and full scale errors. However, due to the breakpoint in the transfer function, single supply operation does not allow for adjustment when the offset is negative. In such cases, the linearity is therefore measured between full-scale and the lowest code that produces a positive (non-zero) output voltage.

POWER SUPPLY DECOUPLING AND GROUNDING

Printed circuit boards with separate analogue and digital ground planes deliver the best system performance. The two ground planes should be connected together at the low impedance power supply source. Ground currents should be managed so as to minimise voltage drops across the ground planes.

A 0.1 μ F decoupling capacitor should be connected between the positive supply and ground pins of the DAC, with short leads as close as possible to the device. Use of ferrite beads may further isolate the system analogue supply from the digital supply.

PACKAGE DIMENSIONS

D: 8 PIN SOIC 3.9mm Wide Body

DM009.B

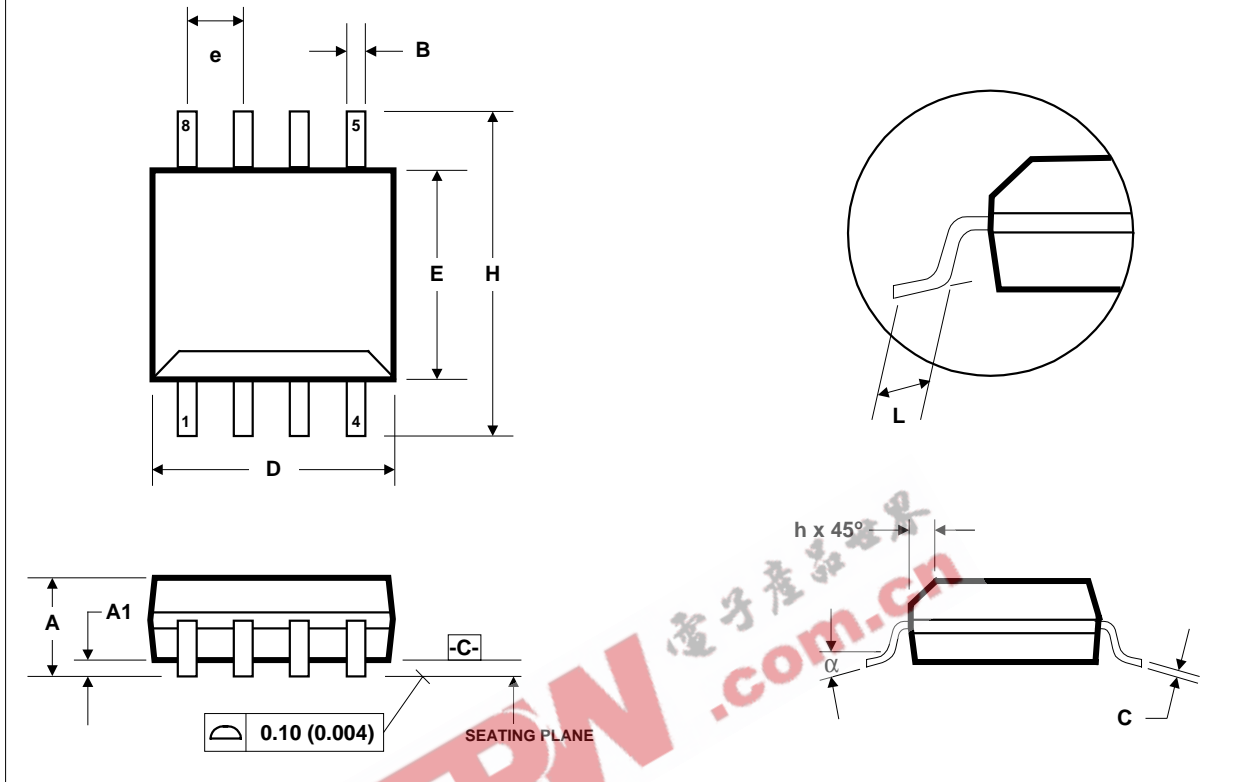

Symbols	Dimensions (mm)		Dimensions (Inches)	
	MIN	MAX	MIN	MAX
A	1.35	1.75	0.0532	0.0688
A ₁	0.10	0.25	0.0040	0.0098
B	0.33	0.51	0.0130	0.0200
C	0.19	0.25	0.0075	0.0098
D	4.80	5.00	0.1890	0.1968
e	1.27 BSC		0.050 BSC	
E	3.80	4.00	0.1497	0.1574
h	0.25	0.50	0.0099	0.0196
H	5.80	6.20	0.2284	0.2440
L	0.40	1.27	0.0160	0.0500
α	0°	8°	0°	8°
REF:	JEDEC.95, MS-012			

NOTES:
 A. ALL LINEAR DIMENSIONS ARE IN MILLIMETERS (INCHES).
 B. THIS DRAWING IS SUBJECT TO CHANGE WITHOUT NOTICE.
 C. BODY DIMENSIONS DO NOT INCLUDE MOLD FLASH OR PROTRUSION, NOT TO EXCEED 0.25MM (0.010IN).
 D. MEETS JEDEC.95 MS-012, VARIATION = AA. REFER TO THIS SPECIFICATION FOR FURTHER DETAILS.