

AD5241/AD5242

FEATURES

- 256 Positions
- 10 k Ω , 100 k Ω , 1 M Ω
- Low Tempco 30 ppm/ $^{\circ}$ C
- Internal Power ON Midscale Preset
- Single-Supply 2.7 V to 5.5 V or
Dual-Supply \pm 2.7 V for AC or Bipolar Operation
- I²C Compatible Interface with Readback Capability
- Extra Programmable Logic Outputs
- Self-Contained Shutdown Feature
- Extended Temperature Range -40° C to $+105^{\circ}$ C

APPLICATIONS

- Multimedia, Video, and Audio Communications
- Mechanical Potentiometer Replacement
- Instrumentation: Gain, Offset Adjustment
- Programmable Voltage-to-Current Conversion
- Line Impedance Matching

GENERAL DESCRIPTION

The AD5241/AD5242 provide a single-/dual-channel, 256-position, digitally controlled variable resistor (VR) device. These devices perform the same electronic adjustment function as a potentiometer, trimmer, or variable resistor. Each VR offers a completely programmable value of resistance between the A Terminal and the wiper, or the B Terminal and the wiper. For AD5242, the fixed A-to-B terminal resistance of 10 k Ω , 100 k Ω , or 1 M Ω has a 1% channel-to-channel matching tolerance. The nominal temperature coefficient of both parts is 30 ppm/ $^{\circ}$ C.

Wiper position programming defaults to midscale at system power ON. Once powered, the VR wiper position is programmed by an I²C compatible 2-wire serial data interface. Both parts have available two extra programmable logic outputs that enable users to drive digital loads, logic gates, LED drivers, and analog switches in their system.

The AD5241/AD5242 are available in surface-mount (SOIC-14/-16) packages and, for ultracompact solutions, TSSOP-14/-16 packages. All parts are guaranteed to operate over the extended temperature range of -40° C to $+105^{\circ}$ C. For 3-wire, SPI compatible interface applications, please refer to AD5200, AD5201, AD5203, AD5204, AD5206, AD5231*, AD5232*, AD5235*, AD7376, AD8400, AD8402, and AD8403 products.

*Nonvolatile digital potentiometer
I²C is a registered trademark of Philips Corporation.

REV. B

Information furnished by Analog Devices is believed to be accurate and reliable. However, no responsibility is assumed by Analog Devices for its use, nor for any infringements of patents or other rights of third parties that may result from its use. No license is granted by implication or otherwise under any patent or patent rights of Analog Devices.

FUNCTIONAL BLOCK DIAGRAM

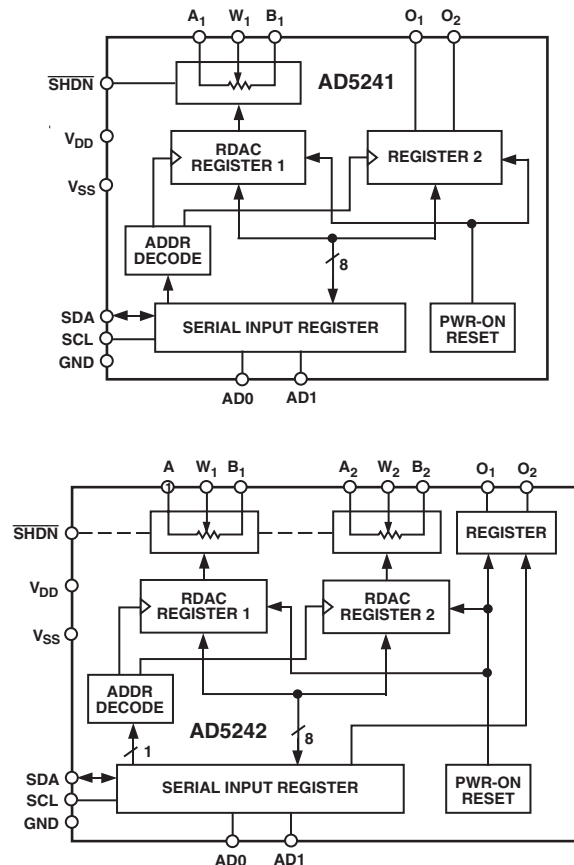

AD5241/AD5242—SPECIFICATIONS

10 kΩ, 100 kΩ, 1 MΩ VERSION

($V_{DD} = 3\text{ V} \pm 10\%$ or $5\text{ V} \pm 10\%$, $V_A = +V_{DD}$, $V_B = 0\text{ V}$, $-40^\circ\text{C} < T_A < +105^\circ\text{C}$, unless otherwise noted.)

Parameter	Symbol	Conditions	Min	Typ ¹	Max	Unit
DC CHARACTERISTICS, RHEOSTAT MODE (Specifications apply to all VRs.)						
Resistor Differential Nonlinearity ²	R-DNL	R_{WB} , $V_A = \text{No Connect}$	-1	±0.4	+1	LSB
Resistor Integral Nonlinearity ²	R-INL	R_{WB} , $V_A = \text{No Connect}$	-2	±0.5	+2	LSB
Nominal Resistor Tolerance	DR	$T_A = 25^\circ\text{C}$, $R_{AB} = 10\text{ k}\Omega$	-30		+30	%
	DR	$T_A = 25^\circ\text{C}$, $R_{AB} = 100\text{ k}\Omega/1\text{ M}\Omega$	-30		+50	%
Resistance Temperature Coefficient	R_{AB}/DT	$V_{AB} = V_{DD}$, Wiper = No Connect		30		ppm/ $^\circ\text{C}$
Wiper Resistance	R_W	$I_W = V_{DD}/R$, $V_{DD} = 3\text{ V}$ or 5 V		60	120	Ω
DC CHARACTERISTICS, POTENTIOMETER DIVIDER MODE (Specifications apply to all VRs.)						
Resolution	N		8			Bits
Differential Nonlinearity ³	DNL		-1	±0.4	+1	LSB
Integral Nonlinearity ³	INL		-2	±0.5	+2	LSB
Voltage Divider Temperature Coefficient	DV_W/DT	Code = 80 _H		5		ppm/ $^\circ\text{C}$
Full-Scale Error	V_{WFSE}	Code = FF _H	-1	-0.5	0	LSB
Zero-Scale Error	V_{WZSE}	Code = 00 _H	0	0.5	1	LSB
RESISTOR TERMINALS						
Voltage Range ⁴	$V_{A, B, W}$		V_{SS}		V_{DD}	V
Capacitance ⁵ A, B	$C_{A, B}$	$f = 1\text{ MHz}$, Measured to GND, Code = 80 _H		45		pF
Capacitance ⁵ W	C_W	$f = 1\text{ MHz}$, Measured to GND, Code = 80 _H		60		pF
Common-Mode Leakage	I_{CM}	$V_A = V_B = V_W$		1		nA
DIGITAL INPUTS						
Input Logic High (SDA and SCL)	V_{IH}		$0.7 V_{DD}$		$V_{DD} + 0.5$	V
Input Logic Low (SDA and SCL)	V_{IL}		-0.5		$+0.3 V_{DD}$	V
Input Logic High (AD0 and AD1)	V_{IH}	$V_{DD} = 5\text{ V}$	2.4		V_{DD}	V
Input Logic Low (AD0 and AD1)	V_{IL}	$V_{DD} = 5\text{ V}$	0		0.8	V
Input Logic High	V_{IH}	$V_{DD} = 3\text{ V}$	2.1		V_{DD}	V
Input Logic Low	V_{IL}	$V_{DD} = 3\text{ V}$	0		0.6	V
Input Current	I_{IL}	$V_{IN} = 0\text{ V}$ or 5 V			1	μA
Input Capacitance ⁵	C_{IL}			3		pF
DIGITAL OUTPUT						
Output Logic Low (SDA)	V_{OL}	$I_{OL} = 3\text{ mA}$			0.4	V
Output Logic Low (O ₁ and O ₂)	V_{OL}	$I_{OL} = 6\text{ mA}$			0.6	V
Output Logic High (O ₁ and O ₂)	V_{OH}	$I_{SINK} = 1.6\text{ mA}$			0.4	V
Output Logic High (O ₁ and O ₂)	V_{OH}	$I_{SOURCE} = 40\text{ }\mu\text{A}$	4			V
Three-State Leakage Current (SDA)	I_{OZ}	$V_{IN} = 0\text{ V}$ or 5 V			±1	μA
Output Capacitance ⁵	C_{OZ}			3	8	pF
POWER SUPPLIES						
Power Single-Supply Range	$V_{DD\text{ RANGE}}$	$V_{SS} = 0\text{ V}$	2.7		5.5	V
Power Dual-Supply Range	$V_{DD/SS\text{ RANGE}}$	±2.3			±2.7	V
Positive Supply Current	I_{DD}	$V_{IH} = 5\text{ V}$ or $V_{IL} = 0\text{ V}$		0.1	50	μA
Negative Supply Current	I_{SS}	$V_{SS} = -2.5\text{ V}$, $V_{DD} = +2.5\text{ V}$		+0.1	-50	μA
Power Dissipation ⁶	P_{DISS}	$V_{IH} = 5\text{ V}$ or $V_{IL} = 0\text{ V}$, $V_{DD} = 5\text{ V}$		0.5	250	μW
Power Supply Sensitivity	PSS		-0.01	+0.002+0.01		%/%
DYNAMIC CHARACTERISTICS ^{5, 7, 8}						
Bandwidth -3 dB	BW_10 kΩ	$R_{AB} = 10\text{ k}\Omega$, Code = 80 _H		650		kHz
	BW_100 kΩ	$R_{AB} = 100\text{ k}\Omega$, Code = 80 _H		69		kHz
	BW_1 MΩ	$R_{AB} = 1\text{ M}\Omega$, Code = 80 _H		6		kHz
Total Harmonic Distortion	THD _W	$V_A = 1\text{ V rms} + 2\text{ V dc}$, $V_B = 2\text{ V dc}$, $f = 1\text{ kHz}$		0.005		%
V_W Settling Time	t_S	$V_A = V_{DD}$, $V_B = 0\text{ V}$, ±1 LSB Error Band, $R_{AB} = 10\text{ k}\Omega$		2		μs
Resistor Noise Voltage	e_{N_WB}	$R_{WB} = 5\text{ k}\Omega$, $f = 1\text{ kHz}$		14		$\text{nV}\sqrt{\text{Hz}}$

Parameter	Symbol	Conditions	Min	Typ ¹	Max	Unit
INTERFACE TIMING CHARACTERISTICS (Applies to all parts. ^{5, 9})						
SCL Clock Frequency	f_{SCL}		0		400	kHz
t_{BUF} Bus Free Time between STOP and START	t_1		1.3			μs
$t_{HD; STA}$ Hold Time (Repeated START)	t_2	After this period, the first clock pulse is generated.	600			ns
t_{LOW} Low Period of SCL Clock	t_3		1.3			μs
t_{HIGH} High Period of SCL Clock	t_4		0.6		50	μs
$t_{SU; STA}$ Setup Time for Repeated START Condition	t_5		600			ns
$t_{HD; DAT}$ Data Hold Time	t_6				900	ns
$t_{SU; DAT}$ Data Setup Time	t_7		100			ns
t_R Rise Time of Both SDA and SCL Signals	t_8				300	ns
t_F Fall Time of Both SDA and SCL Signals	t_9				300	ns
$t_{SU; STO}$ Setup Time for STOP Condition	t_{10}					ns

NOTES

¹Typicals represent average readings at 25°C, $V_{DD} = 5$ V.

²Resistor position nonlinearity error R-INL is the deviation from an ideal value measured between the maximum resistance and the minimum resistance wiper positions. R-DNL measures the relative step change from ideal between successive tap positions. Parts are guaranteed monotonic. See Test Circuits.

³INL and DNL are measured at V_W with the RDAC configured as a potentiometer divider similar to a voltage output D/A converter. $V_A = V_{DD}$ and $V_B = 0$ V. DNL specification limits of ± 1 LSB maximum are guaranteed monotonic operating conditions. See Figure 10.

⁴Resistor terminals A, B, W have no limitations on polarity with respect to each other.

⁵Guaranteed by design and not subject to production test.

⁶ P_{DISS} is calculated from $(I_{DD} \times V_{DD})$. CMOS logic level inputs result in minimum power dissipation.

⁷Bandwidth, noise, and settling time are dependent on the terminal resistance value chosen. The lowest R value results in the fastest settling time and highest bandwidth. The highest R value results in the minimum overall power consumption.

⁸All dynamic characteristics use $V_{DD} = 5$ V.

⁹See timing diagram for location of measured values.

Specifications subject to change without notice.

AD5241/AD5242

ABSOLUTE MAXIMUM RATINGS*

(T_A = 25°C, unless otherwise noted.)

V _{DD} to GND	-0.3 V, +7 V
V _{SS} to GND	0 V, -7 V
V _{DD} to V _{SS}	7 V
V _A , V _B , V _W to GND	V _{SS} , V _{DD}
A _X -B _X , A _X -W _X , B _X -W _X at 10 kΩ in TSSOP-14	±5.0 mA*
A _X -B _X , A _X -W _X , B _X -W _X at 100 kΩ in TSSOP-14	±1.5 mA*
A _X -B _X , A _X -W _X , B _X -W _X at 1 MΩ in TSSOP-14	±0.5 mA*
Digital Input Voltage to GND	0 V, 7 V
Operating Temperature Range	-40°C to +105°C

Thermal Resistance θ_{JA}

SOIC (SOIC-14)	158°C/W
SOIC (SOIC-16)	73°C/W
TSSOP-14	206°C/W
TSSOP-16	180°C/W
Maximum Junction Temperature (T _J max)	150°C
Package Power Dissipation P _D = (T _J max - T _A)/θ _{JA}	
Storage Temperature	-65°C to +150°C
Lead Temperatures	
R-14, R-16A, RU-14, RU-16 (Vapor Phase, 60 sec)	215°C
R-14, R-16A, RU-14, RU-16 (Infrared, 15 sec)	220°C

*Max current increases at lower resistance and different packages.

ORDERING GUIDE

Model	Number of Channels	End to End R _{AB} (Ω)	Temperature Range (°C)	Package Description	Package Option	Number of Devices per Container
AD5241BR10	1	10 k	-40 to +105	SOIC-14	R-14	56
AD5241BR10-REEL7	1	10 k	-40 to +105	SOIC-14	R-14	1000
AD5241BRU10-REEL7	1	10 k	-40 to +105	TSSOP-14	RU-14	1000
AD5241BR100	1	100 k	-40 to +105	SOIC-14	R-14	56
AD5241BR100-REEL7	1	100 k	-40 to +105	SOIC-14	R-14	1000
AD5241BRU100-REEL7	1	100 k	-40 to +105	TSSOP-14	RU-14	1000
AD5241BR1M	1	1 M	-40 to +105	SOIC-14	R-14	56
AD5241BRU1M-REEL7	1	1 M	-40 to +105	TSSOP-14	RU-14	1000
AD5242BR10	2	10 k	-40 to +105	SOIC-16	R-16A	48
AD5242BR10-REEL7	2	10 k	-40 to +105	SOIC-16	R-16A	1000
AD5242BRU10-REEL7	2	10 k	-40 to +105	TSSOP-16	RU-16	1000
AD5242BR100	2	100 k	-40 to +105	SOIC-16	R-16A	48
AD5242BR100-REEL7	2	100 k	-40 to +105	SOIC-16	R-16A	1000
AD5242BRU100-REEL7	2	100 k	-40 to +105	TSSOP-16	RU-16	1000
AD5242BR1M	2	1 M	-40 to +105	SOIC-16	R-16A	48
AD5242BRU1M-REEL7	2	1 M	-40 to +105	TSSOP-16	RU-16	1000

NOTES

¹The AD5241/AD5242 die size is 69 mil × 78 mil, 5,382 sq. mil. Contains 386 transistors for each channel. Patent Number 5495245 applies.

²TSSOP packaged units are only available in 1,000-piece quantity Tape and Reel.

CAUTION

ESD (electrostatic discharge) sensitive device. Electrostatic charges as high as 4000 V readily accumulate on the human body and test equipment and can discharge without detection. Although the AD5241/AD5242 feature proprietary ESD protection circuitry, permanent damage may occur on devices subjected to high energy electrostatic discharges. Therefore, proper ESD precautions are recommended to avoid performance degradation or loss of functionality.



AD5241 PIN CONFIGURATION

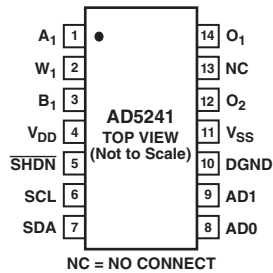

AD5242 PIN CONFIGURATION

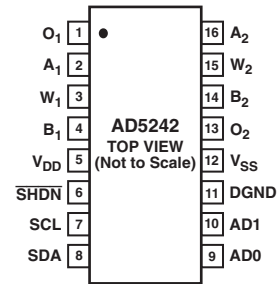

AD5241 PIN FUNCTION DESCRIPTIONS

Pin	Mnemonic	Description
1	A ₁	Resistor Terminal A ₁
2	W ₁	Wiper Terminal W ₁
3	B ₁	Resistor Terminal B ₁
4	V _{DD}	Positive power supply, specified for operation from 2.2 V to 5.5 V.
5	$\overline{\text{SHDN}}$	Active low, asynchronous connection of Wiper W to Terminal B, and open circuit of Terminal A. RDAC register contents unchanged. $\overline{\text{SHDN}}$ should tie to V _{DD} if not used.
6	SCL	Serial Clock Input
7	SDA	Serial Data Input/Output
8	AD0	Programmable address bit for multiple package decoding. Bits AD0 and AD1 provide four possible addresses.
9	AD1	Programmable address bit for multiple package decoding. Bits AD0 and AD1 provide four possible addresses.
10	DGND	Common Ground
11	V _{SS}	Negative power supply, specified for operation from 0 V to -2.7 V.
12	O ₂	Logic Output Terminal O ₂
13	NC	No Connect
14	O ₁	Logic Output Terminal O ₁

AD5242 PIN FUNCTION DESCRIPTIONS

Pin	Mnemonic	Description
1	O ₁	Logic Output Terminal O ₁
2	A ₁	Resistor Terminal A ₁
3	W ₁	Wiper Terminal W ₁
4	B ₁	Resistor Terminal B ₁
5	V _{DD}	Positive power supply, specified for operation from 2.2 V to 5.5 V.
6	$\overline{\text{SHDN}}$	Active low, asynchronous connection of Wiper W to Terminal B, and open circuit of Terminal A. RDAC register contents unchanged. $\overline{\text{SHDN}}$ should tie to V _{DD} if not used.
7	SCL	Serial Clock Input
8	SDA	Serial Data Input/Output
9	AD0	Programmable address bit for multiple package decoding. Bits AD0 and AD1 provide four possible addresses.
10	AD1	Programmable address bit for multiple package decoding. Bits AD0 and AD1 provide four possible addresses.
11	DGND	Common Ground
12	V _{SS}	Negative power supply, specified for operation from 0 V to -2.7 V.
13	O ₂	Logic Output Terminal O ₂
14	B ₂	Resistor Terminal B ₂
15	W ₂	Wiper Terminal W ₂
16	A ₂	Resistor Terminal A ₂

AD5241/AD5242

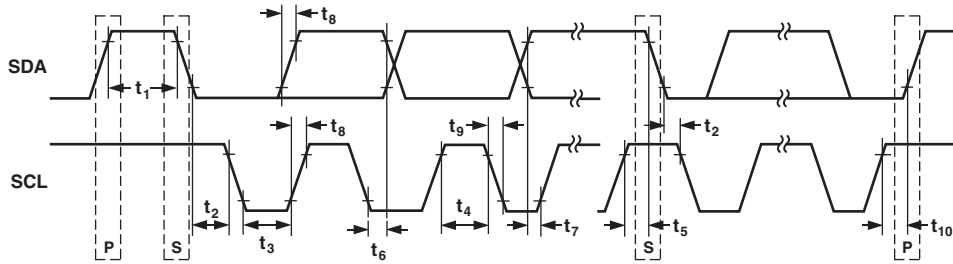

Figure 1. Detail Timing Diagram

Data of AD5241/AD5242 is accepted from the I²C bus in the following serial format:

S	0	1	0	1	1	AD1	AD0	R/W	A	\bar{A}/B	RS	SD	O ₁	O ₂	X	X	X	A	D7	D6	D5	D4	D3	D2	D1	D0	A	P
SLAVE ADDRESS BYTE									INSTRUCTION BYTE									DATA BYTE										

where:

S = Start Condition

P = Stop Condition

A = Acknowledge

X = Don't Care

AD1, AD0 = Package pin programmable address bits. Must be matched with the logic states at Pins AD1 and AD0.

R/W = Read Enable at High and output to SDA. Write Enable at Low.

\bar{A}/B = RDAC subaddress select. '0' for RDAC1 and '1' for RDAC2.

RS = Midscale reset, active high.

SD = Shutdown in active high. Same as $\overline{\text{SHDN}}$ except inverse logic.

O₁, O₂ = Output logic pin latched values.

D7, D6, D5, D4, D3, D2, D1, D0 = Data Bits.

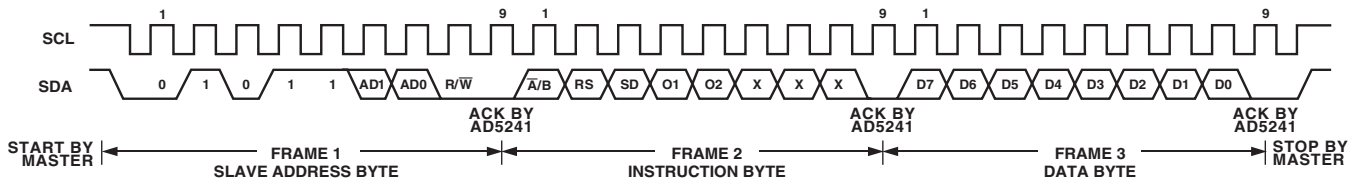

Figure 2. Writing to the RDAC Serial Register

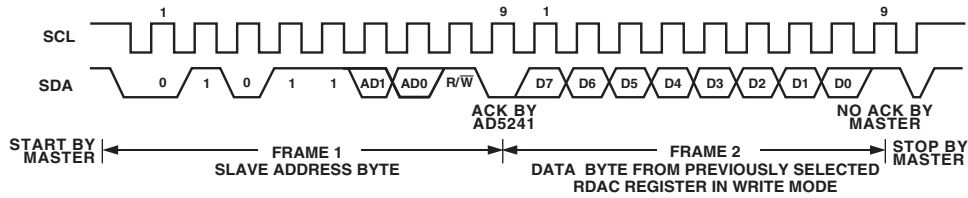
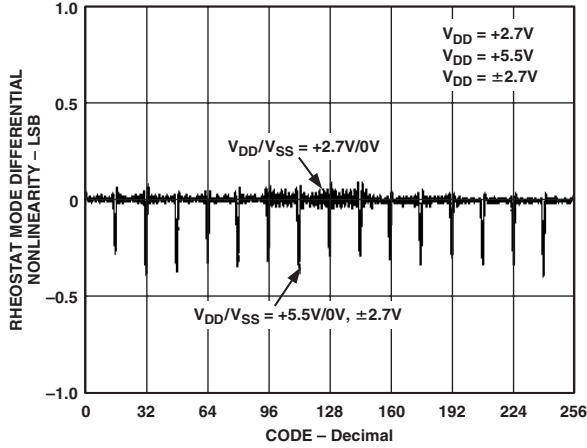
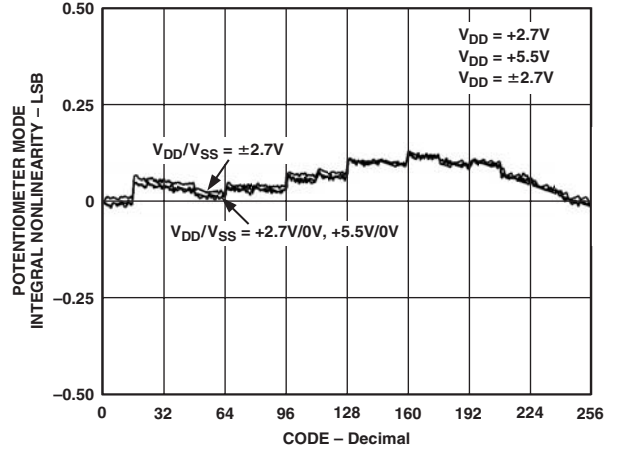

Figure 3. Reading Data from a Previously Selected RDAC Register in Write Mode

Typical Performance Characteristics—AD5241/AD5242



TPC 1. RDNL vs. Code



TPC 4. INL vs. Code

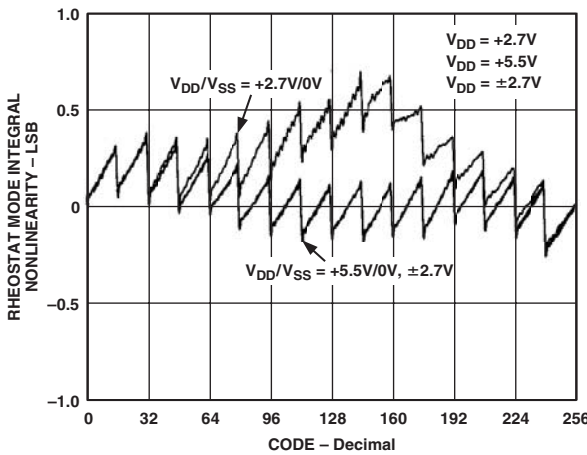

TPC 2. RINL vs. Code

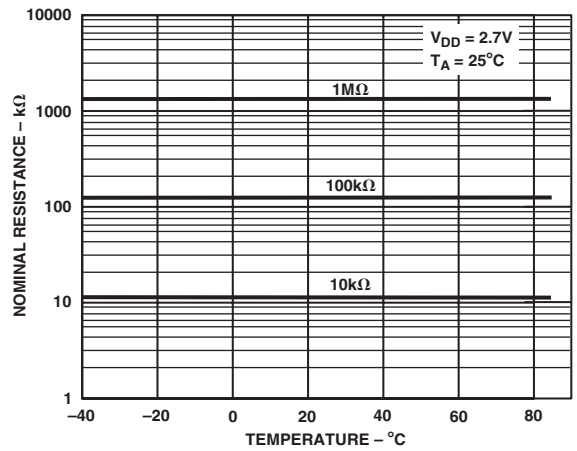

TPC 5. Nominal Resistance vs. Temperature

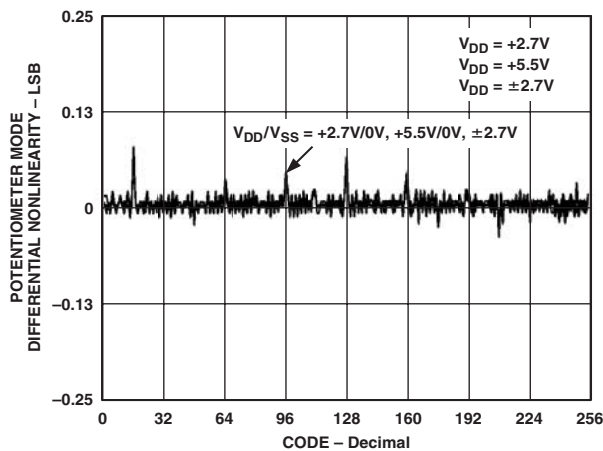

TPC 3. DNL vs. Code

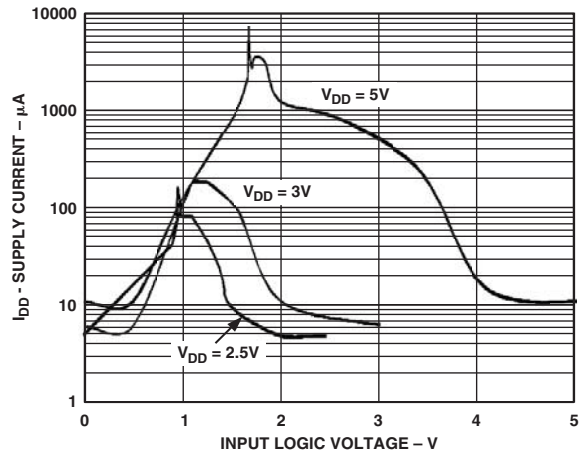

TPC 6. Supply Current vs. Input Logic Voltage

AD5241/AD5242

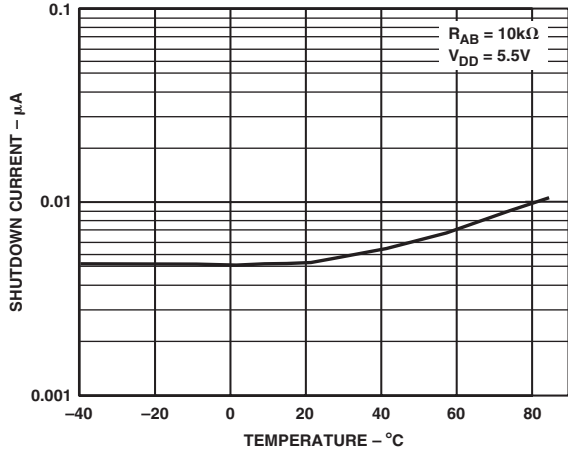

TPC 7. Shutdown Current vs. Temperature

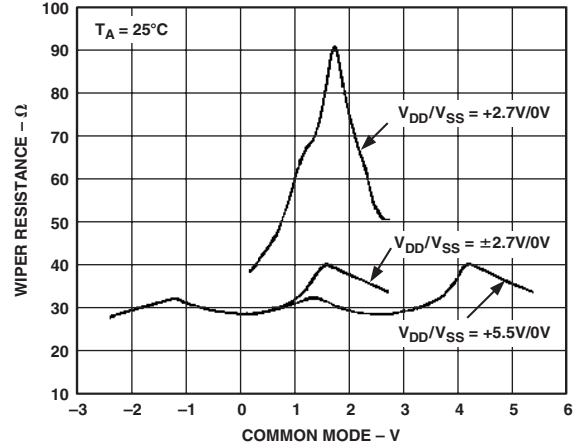

TPC 10. Incremental Wiper Contact vs. V_{DD}/V_{SS}

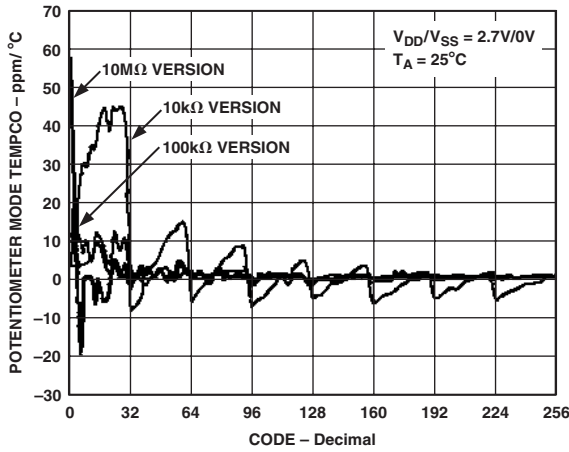

TPC 8. $\Delta V_{WB}/\Delta T$ Potentiometer Mode Tempco

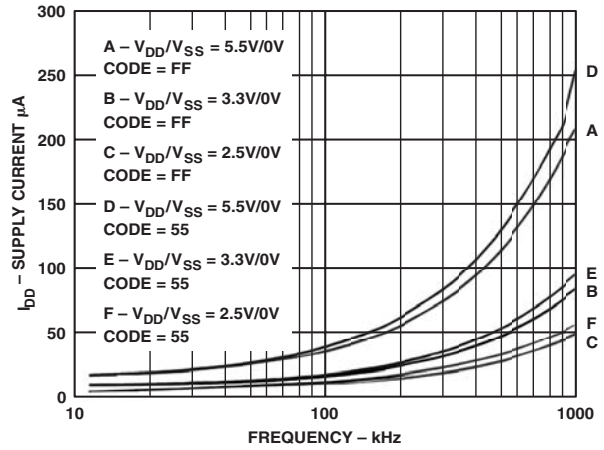

TPC 11. Supply Current vs. Frequency

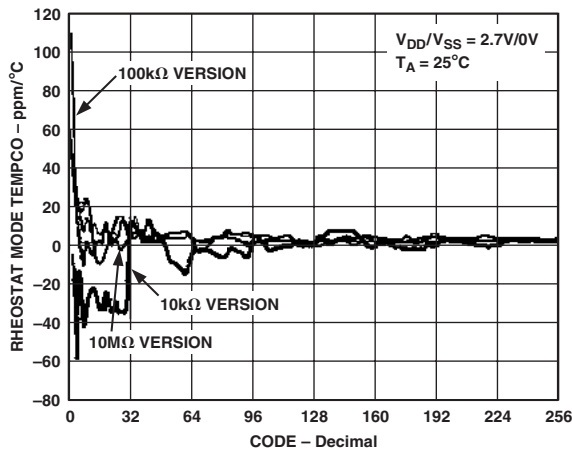

TPC 9. $\Delta R_{WB}/\Delta T$ Rheostat Mode Tempco

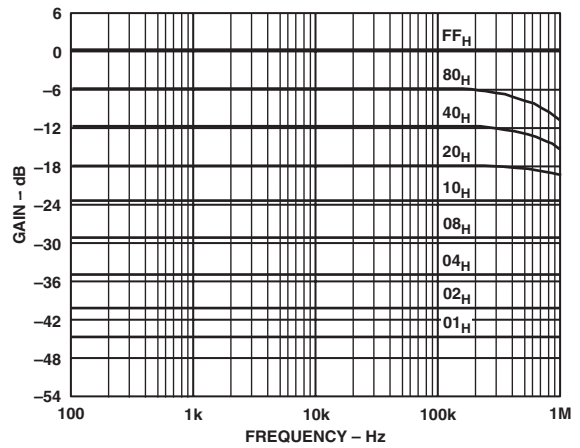

TPC 12. AD5242 10 kΩ Gain vs. Frequency vs. Code

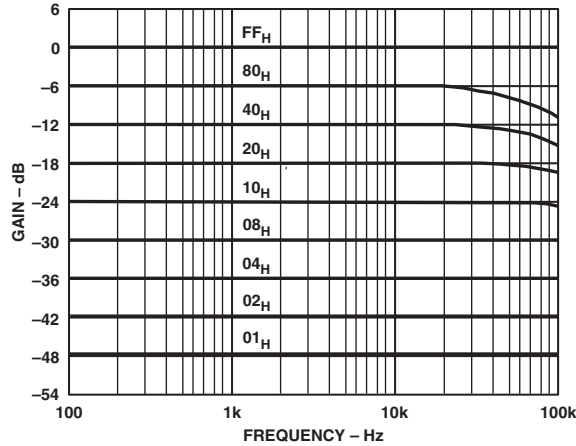

TPC 13. AD5242 100 kΩ Gain vs. Frequency vs. Code

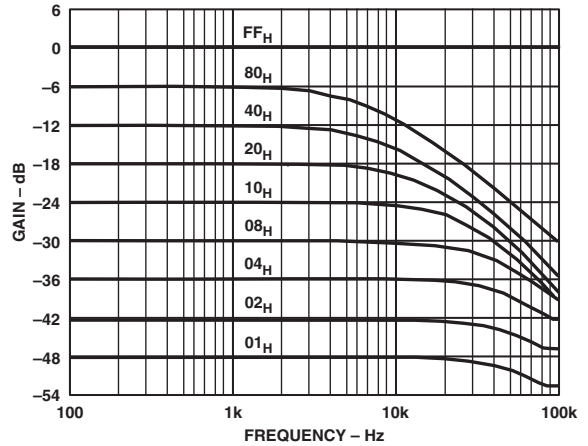

TPC 14. AD5242 1 MΩ Gain vs. Frequency vs. Code

OPERATION

The AD5241/AD5242 provide a single-/dual-channel, 256-position digitally controlled variable resistor (VR) device. The terms VR, RDAC, and programmable resistor are commonly used interchangeably to refer to digital potentiometer.

To program the VR settings, refer to the Digital Interface section. Both parts have an internal power ON preset that places the wiper in midscale during power-on, which simplifies the fault condition recovery at power-up. In addition, the shutdown $\overline{\text{SHDN}}$ Pin of AD5241/AD5242 places the RDAC in an almost zero power consumption state where Terminal A is open circuited and Wiper W is connected to Terminal B, resulting in only leakage current being consumed in the VR structure. During shutdown, the VR latch contents are maintained when the RDAC is inactive. When the part is returned from shutdown, the stored VR setting will be applied to the RDAC.

PROGRAMMING THE VARIABLE RESISTOR

Rheostat Operation

The nominal resistance of the RDAC between Terminals A and B is available in 10 kΩ, 100 kΩ, and 1 MΩ. The final two or three digits of the part number determine the nominal resistance value, e.g., 10 kΩ = 10; 100 kΩ = 100; 1 MΩ = 1 M. The nominal resistance (R_{AB}) of the VR has 256 contact points accessed by the Wiper Terminal, plus the B Terminal contact. The 8-bit data in the RDAC latch is decoded to select one of the 256 possible settings. Assume a 10 kΩ part is used; the wiper's first connection starts at the B Terminal for data 00_H. Since there is a 60 Ω wiper contact resistance, such connection yields a minimum of 60 Ω resistance between Terminals W and B. The second connection is the first tap point that corresponds to 99 Ω ($R_{WB} = R_{AB}/256 + R_W = 39 + 60$) for data 01_H. The third connection is the next tap point representing 138 Ω ($39 \times 2 + 60$) for data 02_H, and so on. Each LSB data value increase moves the wiper up the resistor ladder until the last tap point is reached at 10021 Ω [$R_{AB} - 1 \text{ LSB} + R_W$]. Figure 4 shows a simplified diagram of the equivalent RDAC circuit where the last resistor string will not be accessed; therefore, there is 1 LSB less of the nominal resistance at full scale in addition to the wiper resistance.

The general equation determining the digitally programmed resistance between W and B is:

$$R_{WB}(D) = \frac{D}{256} \times R_{AB} + R_W \tag{1}$$

where:

D is the decimal equivalent of the binary code between 0 and 255, which is loaded in the 8-bit RDAC register.

R_{AB} is the nominal end-to-end resistance.

R_W is the wiper resistance contributed by the on resistance of the internal switch.

Again, if $R_{AB} = 10 \text{ k}\Omega$ and the A Terminal can be either open circuit or tied to W, the following output resistance at R_{WB} will be set for the following RDAC latch codes.

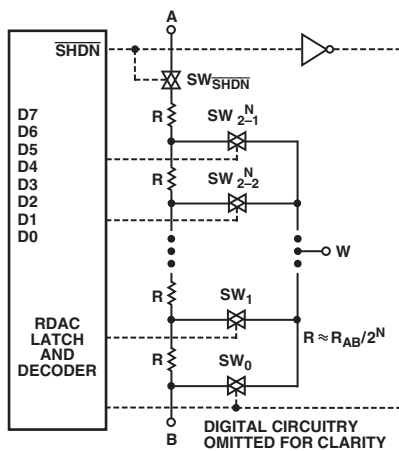

Figure 4. Equivalent RDAC Circuit

AD5241/AD5242

D (DEC)	R _{WB} (Ω)	Output State
255	10021	Full-Scale (R _{WB} – 1 LSB + R _W)
128	5060	Midscale
1	99	1 LSB
0	60	Zero-Scale (Wiper Contact Resistance)

Note that in the zero-scale condition, a finite wiper resistance of 60 Ω is present. Care should be taken to limit the current flow between W and B in this state to a maximum current of no more than ±20 mA. Otherwise, degradation or possible destruction of the internal switch contact can occur.

Similar to the mechanical potentiometer, the resistance of the RDAC between Wiper W and Terminal A also produces a digitally controlled resistance, R_{WA}. When these terminals are used, the B Terminal can be opened or tied to the Wiper Terminal. Setting the resistance value for R_{WA} starts at a maximum value of resistance and decreases as the data loaded in the latch increases in value. The general equation for this operation is:

$$R_{WA}(D) = \frac{256-D}{256} \times R_{AB} + R_W \quad (2)$$

For R_{AB} = 10 kΩ, and the B Terminal can be either open circuit or tied to W. The following output resistance R_{WA} will be set for the following RDAC latch codes.

D (DEC)	R _{WA} (Ω)	Output State
255	99	Full-Scale
128	5060	Midscale
1	10021	1 LSB
0	10060	Zero-Scale

The typical distribution of the nominal resistance R_{AB} from channel to channel matches within ±1% for AD5242. Device-to-device matching is process lot dependent and it is possible to have ±30% variation. Since the resistance element is processed in thin film technology, the change in R_{AB} with temperature has no more than a 30 ppm/°C temperature coefficient.

PROGRAMMING THE POTENTIOMETER DIVIDER Voltage Output Operation

The digital potentiometer easily generates output voltages at wiper-to-B and wiper-to-A to be proportional to the input voltage at A-to-B. Unlike the polarity of V_{DD} – V_{SS}, which must be positive, voltage across A–B, W–A, and W–B can be at either polarity provided that V_{SS} is powered by a negative supply.

If ignoring the effect of the wiper resistance for approximation, connecting the A Terminal to 5 V and the B Terminal to ground produces an output voltage at the wiper-to-B starting at 0 V up to 1 LSB less than 5 V. Each LSB of voltage is equal to the voltage applied across Terminal AB divided by the 256 positions of the potentiometer divider. Since AD5241/AD5242 can be supplied by dual supplies, the general equation defining the output voltage at V_W with respect to ground for any valid input voltage applied to Terminals A and B is:

$$V_W(D) = \frac{D}{256} V_A + \frac{256-D}{256} V_B \quad (3)$$

which can be simplified to

$$V_W(D) = \frac{D}{256} V_{AB} + V_B \quad (4)$$

where D is the decimal equivalent of the binary code between 0 to 255 that is loaded in the 8-bit RDAC register.

For more accurate calculation including the effects of wiper resistance, V_W can be found as:

$$V_W(D) = \frac{R_{WB}(D)}{R_{AB}} V_A + \frac{R_{WA}(D)}{R_{AB}} V_B \quad (5)$$

where R_{WB}(D) and R_{WA}(D) can be obtained from Equations 1 and 2.

Operation of the digital potentiometer in the Divider Mode results in a more accurate operation over temperature. Unlike the Rheostat Mode, the output voltage is dependent on the ratio of the internal resistors R_{WA} and R_{WB}, and not the absolute values; therefore, the temperature drift reduces to 5 ppm/°C.

DIGITAL INTERFACE

2-Wire Serial Bus

The AD5241/AD5242 are controlled via an I²C compatible serial bus. The RDACs are connected to this bus as slave devices.

Referring to Figures 2 and 3, the first byte of AD5241/AD5242 is a Slave Address Byte. It has a 7-bit slave address and an R_W Bit. The 5 MSBs are 01011 and the following two bits are determined by the state of the AD0 and AD1 Pins of the device. AD0 and AD1 allow users to use up to four of these devices on one bus.

The 2-wire I²C serial bus protocol operates as follows:

1. The master initiates data transfer by establishing a START condition, which is when a high-to-low transition on the SDA line occurs while SCL is high (Figure 2). The following byte is the Slave Address Byte, Frame 1, which consists of the 7-bit slave address followed by an R_W Bit (this bit determines whether data will be read from or written to the slave device).

The slave whose address corresponds to the transmitted address will respond by pulling the SDA line low during the ninth clock pulse (this is termed the Acknowledge Bit). At this stage, all other devices on the bus remain idle while the selected device waits for data to be written to or read from its serial register. If the R_W Bit is high, the master will read from the slave device. If the R_W Bit is low, the master will write to the slave device.

2. A Write operation contains an extra Instruction Byte more than the Read operation. This Instruction Byte, Frame 2, in Write Mode follows the Slave Address Byte. The MSB of the Instruction Byte labeled A/B is the RDAC subaddress select. A “low” selects RDAC1 and a “high” selects RDAC2 for the dual-channel AD5242. Set A/B to low for AD5241. The second MSB, RS, is the midscale reset. A logic high of this bit moves the wiper of a selected RDAC to the center tap where R_{WA} = R_{WB}. The third MSB, SD, is a shutdown bit. A logic high on SD causes the RDAC open circuit at Terminal A while shorting the wiper to Terminal B. This operation yields almost a 0 Ω in Rheostat Mode or 0 V in Potentiometer Mode. This SD Bit serves the same function as the SHDN

Pin except that $\overline{\text{SHDN}}$ Pin reacts to active low. The following two bits are O_2 and O_1 . They are extra programmable logic outputs that users can use to drive other digital loads, logic gates, LED drivers, analog switches, and the like. The three LSBs are Don't Care. See Figure 2.

3. After acknowledging the Instruction Byte, the last byte in Write Mode is the Data Byte, Frame 3. Data is transmitted over the serial bus in sequences of nine clock pulses (eight data bits followed by an Acknowledge Bit). The transitions on the SDA line must occur during the low period of SCL and remain stable during the high period of SCL (Figure 2).
4. Unlike the Write Mode, the Data Byte follows immediately after the acknowledgment of the Slave Address Byte in Read Mode, Frame 2. Data is transmitted over the serial bus in sequences of nine clock pulses (slightly different than the Write Mode, there are eight data bits followed by a No Acknowledge logic 1 Bit in Read Mode). Similarly, the transitions on the SDA line must occur during the low period of SCL and remain stable during the high period of SCL. See Figure 3.
5. When all Data Bits have been read or written, a STOP condition is established by the master. A STOP condition is defined as a low-to-high transition on the SDA line while SCL is high. In Write Mode, the master will pull the SDA line high during the tenth clock pulse to establish a STOP condition (see Figure 2). In Read Mode, the master will issue a No Acknowledge for the ninth clock pulse (i.e., the SDA line remains high). The master will then bring the SDA line low before the tenth clock pulse, which goes high to establish a STOP condition (see Figure 3).

A repeated Write function gives the user flexibility to update the RDAC output a number of times after addressing and instructing the part only once. During the Write cycle, each Data Byte will update the RDAC output. For example, after the RDAC has acknowledged its Slave Address and Instruction Bytes, the RDAC output will be updated. If another byte is written to the RDAC while it is still addressed to a specific slave device with the same instruction, this byte will update the output of the selected slave device. If different instructions are needed, the Write Mode has to start a whole new sequence with a new Slave Address, Instruction, and Data Bytes transferred again. Similarly, a repeated Read function of the RDAC is also allowed.

READBACK RDAC VALUE

Specific to the AD5242 dual-channel device, the channel of interest is the one that was previously selected in the Write Mode. In addition, to read both RDAC values consecutively, users have to perform two write-read cycles. For example, users may first specify the RDAC1 subaddress in the Write Mode (it is not necessary to issue the Data Byte and the STOP condition), then change to the Read Mode and read the RDAC1 value. To continue reading the RDAC2 value, users have to switch back to the Write Mode and specify the subaddress, then switch once again to the Read Mode and read the RDAC2 value. It is not necessary to issue the Write Mode Data Byte or the first stop condition for this operation. Users should refer to Figures 2 and 3 for the programming format.

MULTIPLE DEVICES ON ONE BUS

Figure 5 shows four AD5242 devices on the same serial bus. Each has a different slave address since the state of their AD0 and AD1 Pins are different. This allows each RDAC within

each device to be written to or read from independently. The master device output bus line drivers are open-drain pull-downs in a fully I²C compatible interface. Note, a device will be addressed properly only if the bit information of AD0 and AD1 in the Slave Address Byte matches with the logic inputs at pins AD0 and AD1 of that particular device.

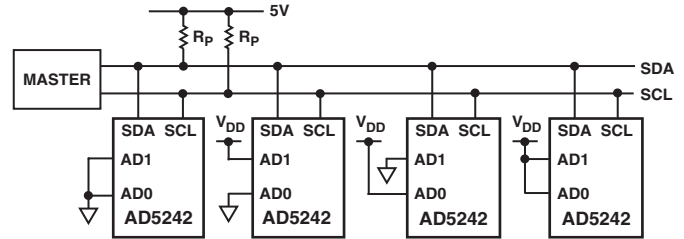

Figure 5. Multiple AD5242 Devices on One Bus

LEVEL-SHIFT FOR BIDIRECTIONAL INTERFACE

While most old systems may be operated at one voltage, a new component may be optimized at another. When they operate the same signal at two different voltages, a proper method of level-shifting is needed. For instance, one can use a 3.3 V E²PROM to interface with a 5 V digital potentiometer. A level-shift scheme is needed in order to enable a bidirectional communication so that the setting of the digital potentiometer can be stored to and retrieved from the E²PROM. Figure 6 shows one of the techniques. M1 and M2 can be N-Ch FETs 2N7002 or low threshold FDV301N if V_{DD} falls below 2.5 V.

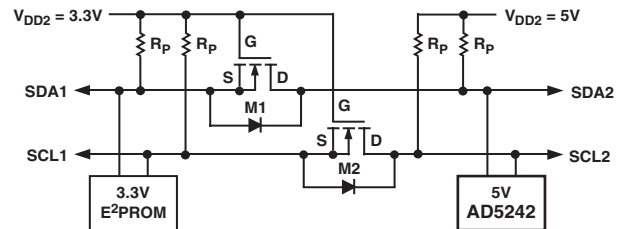

Figure 6. Level-Shift for Different Voltage Devices Operation

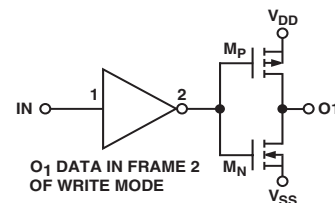

Figure 7. Output Stage of Logic Output O₁

ADDITIONAL PROGRAMMABLE LOGIC OUTPUT

AD5241/AD5242 feature additional programmable logic outputs, O_1 and O_2 , that can be used to drive digital load, analog switches, and logic gates. They can also be used as self-contained shutdown as preset to logic 0 feature which will be explained later. O_1 and O_2 default to logic 0 during power-up. The logic states of O_1 and O_2 can be programmed in Frame 2 under the Write Mode (see Figure 2). Figure 7 shows the output stage of O_1 which employs large P and N channel MOSFETs in push-pull configuration. As shown, the output will be equal to V_{DD} or V_{SS} , and these logic outputs have adequate current driving capability to drive milliamperes of load.

AD5241/AD5242

Users can also activate O_1 and O_2 in three different ways without affecting the wiper settings.

1. Start, Slave Address Byte, Acknowledge, Instruction Byte with O_1 and O_2 specified, Acknowledge, Stop.
2. Complete the write cycle with Stop, then Start, Slave Address Byte, Acknowledge, Instruction Byte with O_1 and O_2 specified, Acknowledge, Stop.
3. Do not complete the write cycle by not issuing the Stop, then Start, Slave Address Byte, Acknowledge, Instruction Byte with O_1 and O_2 specified, Acknowledge, Stop.

All digital inputs are protected with a series input resistor and parallel Zener ESD structures shown in Figure 9. This applies to digital input Pins SDA, SCL, and $\overline{\text{SHDN}}$.

SELF-CONTAINED SHUTDOWN FUNCTION

Shutdown can be activated by strobing the $\overline{\text{SHDN}}$ Pin or programming the SD Bit in the Write Mode Instruction Byte. In addition, shutdown can even be implemented with the device digital output as shown in Figure 8. In this configuration, the device will be shut down during power-up, but users are allowed to program the device. Thus when O_1 is programmed high, the device will exit from the shutdown mode and respond to the new setting. This self-contained shutdown function allows absolute shutdown during power-up, which is crucial in hazardous environments without adding extra components.

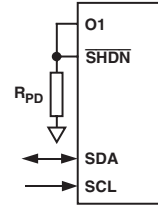

Figure 8. Shutdown by Internal Logic Output

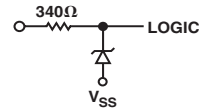

Figure 9. ESD Protection of Digital Pins

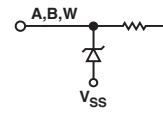
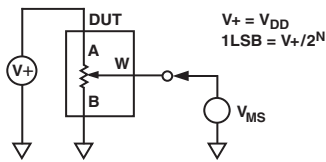

Figure 10. ESD Protection of Resistor Terminals

Test Circuits

Test Circuits 1 to 9 define the test conditions used in the product specifications table.



Test Circuit 1. Potentiometer Divider Nonlinearity Error (INL, DNL)

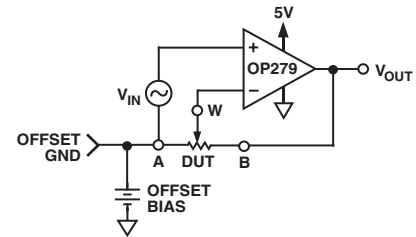

Test Circuit 6. Noninverting Gain

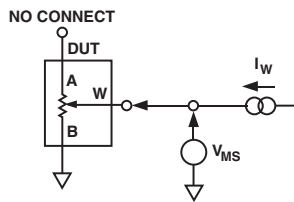

Test Circuit 2. Resistor Position Nonlinearity Error (Rheostat Operation; R-INL, R-DNL)

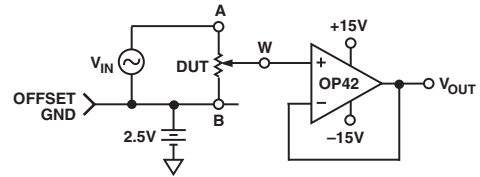

Test Circuit 7. Gain vs. Frequency

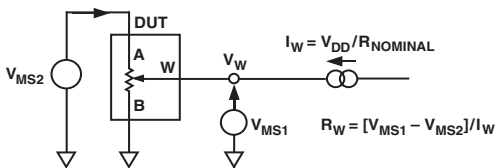

Test Circuit 3. Wiper Resistance

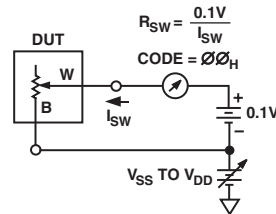

Test Circuit 8. Incremental ON Resistance

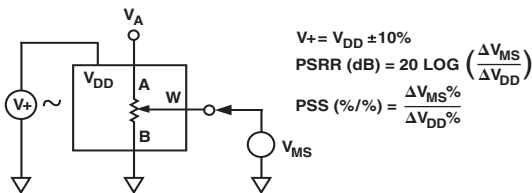

Test Circuit 4. Power Supply Sensitivity (PSS, PSRR)

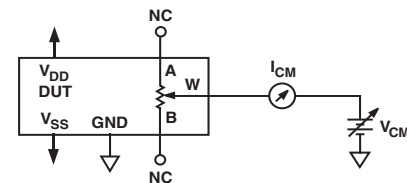

Test Circuit 9. Common-Mode Leakage Current

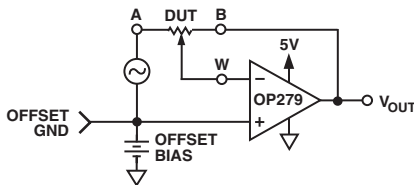

Test Circuit 5. Inverting Gain

AD5241/AD5242

DIGITAL POTENTIOMETER SELECTION GUIDE

Part Number	Number of VRs per Package ¹	Terminal Voltage Range	Interface Data Control ²	Nominal Resistance (k Ω)	Resolution (Number of Wiper Positions)	Power Supply Current (I _{DD})	Packages	Comments
AD5201	1	± 3 V, +5.5 V	3-Wire	10, 50	33	40 μ A	MSOP-10	Full AC Specs, Dual Supply, Power-On-Reset, Low Cost
AD5220	1	5.5 V	Up/Down	10, 50, 100	128	40 μ A	PDIP, SO-8, MSOP-8	No Rollover, Power-On-Reset
AD7376	1	± 15 V, +28 V	3-Wire	10, 50, 100, 1000	128	100 μ A	PDIP-14, SOL-16, TSSOP-14	Single 28 V or Dual ± 15 V Supply Operation
AD5200	1	± 3 V, +5.5 V	3-Wire	10, 50	256	40 μ A	MSOP-10	Full AC Specs, Dual Supply, Power-On-Reset
AD8400	1	5.5 V	3-Wire	1, 10, 50, 100	256	5 μ A	SOIC-8	Full AC Specs
AD5241	1	± 3 V, +5.5 V	2-Wire	10, 100, 1000	256	50 μ A	SOIC-14, TSSOP-14	I ² C Compatible, TC < 50 ppm/ $^{\circ}$ C
AD5231	1	± 2.75 V, +5.5 V	3-Wire	10, 50, 100	1024	10 μ A	TSSOP-16	Nonvolatile Memory, Direct Program, I/D, ± 6 dB Settability
AD5260	1	± 5 V, +15 V	3-Wire	20, 50, 200	256	60 μ A	TSSOP-14	TC < 50 ppm/ $^{\circ}$ C
AD5207	2	± 3 V, +5.5 V	3-Wire	10, 50, 100	256	40 μ A	TSSOP-14	Full AC Specs, SVO
AD5222	2	± 3 V, +5.5 V	Up/Down	10, 50, 100, 1000	128	80 μ A	SOIC-14, TSSOP-14	No Rollover, Stereo, Power-On-Reset, TC < 50 ppm/ $^{\circ}$ C
AD8402	2	5.5 V	3-Wire	1, 10, 50, 100	256	5 μ A	PDIP, SOIC-14, TSSOP-14	Full AC Specs, nA Shutdown Current
AD5232	2	± 2.75 V, +5.5 V	3-Wire	10, 50, 100	256	10 μ A	TSSOP-16	Nonvolatile Memory, Direct Program, I/D, ± 6 dB Settability
AD5235	2	± 2.75 V, +5.5 V	3-Wire	25, 250	1024	5 μ A	TSSOP-16	Nonvolatile Memory, TC < 50 ppm/ $^{\circ}$ C
AD5242	2	± 3 V, +5.5 V	2-Wire	10, 100, 1000	256	50 μ A	SOIC-16, TSSOP-16	I ² C Compatible, TC < 50 ppm/ $^{\circ}$ C
AD5262	2	± 5 V, +12 V	3-Wire	20, 50, 200	256	60 μ A	TSSOP-16	Medium Voltage Operation, TC < 50 ppm/ $^{\circ}$ C
AD5203	4	5.5 V	3-Wire	10, 100	64	5 μ A	PDIP, SOL-24, TSSOP-24	Full AC Specs, nA Shutdown Current
AD5233	4	± 2.75 V, +5.5 V	3-Wire	10, 50, 100	64	10 μ A	TSSOP-24	Nonvolatile Memory, Direct Program, I/D, ± 6 dB Settability
AD5204	4	± 3 V, +5.5 V	3-Wire	10, 50, 100	256	60 μ A	PDIP, SOL-24, TSSOP-24	Full AC Specs, Dual Supply, Power-On-Reset
AD8403	4	5.5 V	3-Wire	1, 10, 50, 100	256	5 μ A	PDIP, SOL-24, TSSOP-24	Full AC Specs, nA Shutdown Current
AD5206	6	± 3 V, +5.5 V	3-Wire	10, 50, 100	256	60 μ A	PDIP, SOL-24, TSSOP-24	Full AC Specs, Dual Supply, Power-On-Reset

NOTES

¹VR stands for variable resistor. This term is used interchangeably with RDAC, programmable resistor, and digital potentiometer.

²3-wire interface is SPI and Microwire compatible. 2-wire interface is I²C compatible.

OUTLINE DIMENSIONS

14-Lead Thin Shrink Small Outline Package [TSSOP] (RU-14)

Dimensions shown in millimeters

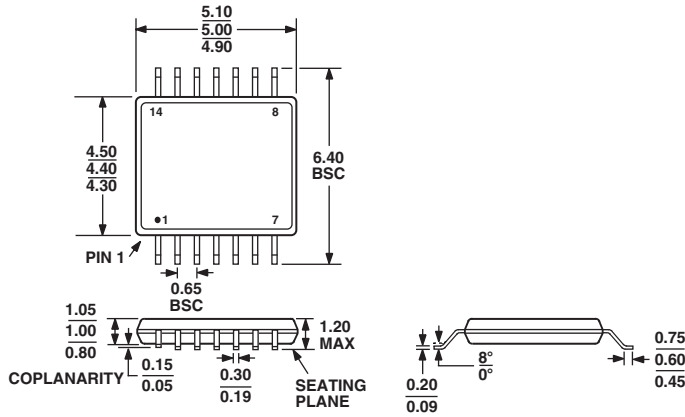

COMPLIANT TO JEDEC STANDARDS MO-153AB-1

16-Lead Thin Shrink Small Outline Package [TSSOP] (RU-16)

Dimensions shown in millimeters

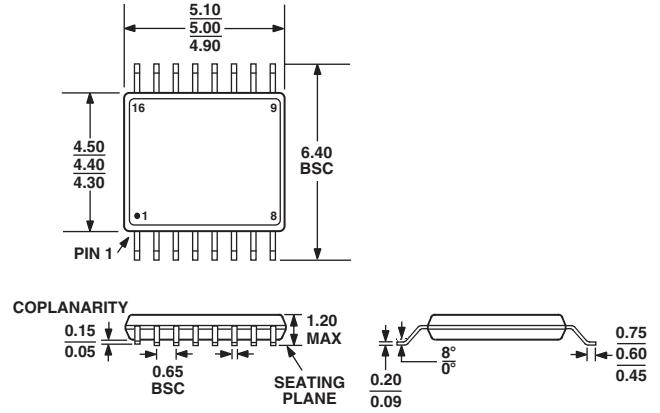

COMPLIANT TO JEDEC STANDARDS MO-153AB

14-Lead Standard Small Outline Package [SOIC] Narrow Body (R-14)

Dimensions shown in millimeters and (inches)

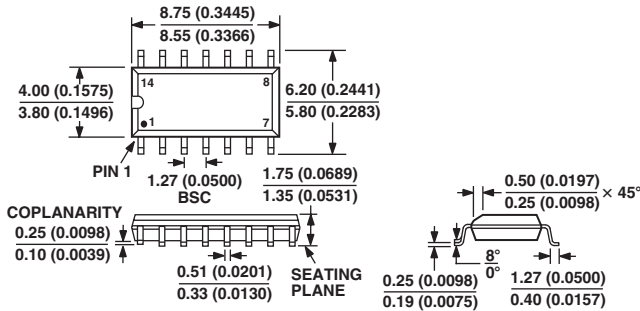

CONTROLLING DIMENSIONS ARE IN MILLIMETERS; INCH DIMENSIONS (IN PARENTHESES) ARE ROUNDED-OFF MILLIMETER EQUIVALENTS FOR REFERENCE ONLY AND ARE NOT APPROPRIATE FOR USE IN DESIGN
COMPLIANT TO JEDEC STANDARDS MS-012 AB

16-Lead Standard Small Outline Package [SOIC] Narrow Body (R-16A)

Dimensions shown in millimeters and (inches)

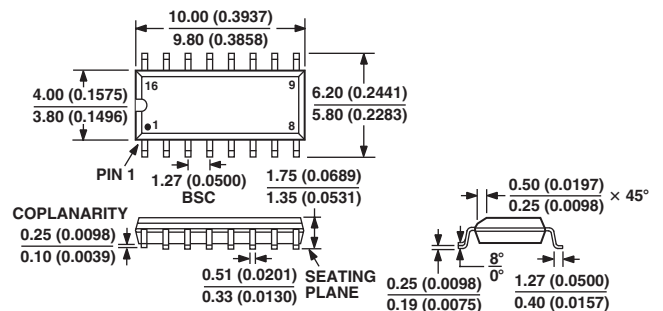

CONTROLLING DIMENSIONS ARE IN MILLIMETERS; INCH DIMENSIONS (IN PARENTHESES) ARE ROUNDED-OFF MILLIMETER EQUIVALENTS FOR REFERENCE ONLY AND ARE NOT APPROPRIATE FOR USE IN DESIGN
COMPLIANT TO JEDEC STANDARDS MS-012 AC

AD5241/AD5242

Revision History

Location	Page
8/02—Data Sheet changed from REV. A to REV. B.	
Additions to FEATURES	1
Changes to GENERAL DESCRIPTION	1
Changes to SPECIFICATIONS	2
Changes to ABSOLUTE MAXIMUM RATINGS	4
Additions to ORDERING GUIDE	4
Changes to TPC 8 and TPC 9	8
Changes to READBACK RDAC VALUE section	11
Changes to ADDITIONAL PROGRAMMABLE LOGIC OUTPUT section	11
Added SELF-CONTAINED SHUTDOWN section	12
Added new Figure 8	12
Changes to DIGITAL POTENTIOMETER SELECTION GUIDE	14
2/02—Data Sheet changed from REV. 0 to REV. A.	
Edits to FEATURES	1
Edits to FUNCTIONAL BLOCK DIAGRAMS	1
Edits to ABSOLUTE MAXIMUM RATINGS	4
Changes to ORDERING GUIDE	4
Edits to PIN FUNCTION DESCRIPTIONS	5
Edits to Figures 1, 2, 3	6
Addition of Readback RDAC Value and Additional Programmable Logic Output sections, and addition of new Figure 7 (which changed succeeding figure numbers)	11
Additions/edits to DIGITAL POTENTIOMETER SELECTION GUIDE	14

C00926-0-8/02(B)

PRINTED IN U.S.A.