

FEATURES

- 2 independent linear-in-dB channels**
- Input noise at maximum gain: 1.8 nV/ $\sqrt{\text{Hz}}$, 2.7 pA/ $\sqrt{\text{Hz}}$**
- Bandwidth: 40 MHz (–3 dB)**
- Differential input**
- Absolute gain range programmable**
 - 14 dB to +34 dB (FBK shorted to OUT) through
 - 0 dB to 48 dB (FBK open)
- Variable gain scaling: 20 dB/V through 40 dB/V**
- Stable gain with temperature and supply variations**
- Single-ended unipolar gain control**
- Output common mode independently set**
- Power shutdown at lower end of gain control**
- Single 5 V supply**
- Low power: 90 mW/channel**
- Drives ADCs directly**

APPLICATIONS

- Ultrasound and sonar time-gain controls**
- High performance AGC systems**
- Signal measurement**

GENERAL DESCRIPTION

The AD605 is a low noise, accurate, dual-channel, linear-in-dB variable gain amplifier (VGA), optimized for any application requiring high performance, wide bandwidth variable gain control. Operating from a single 5 V supply, the AD605 provides differential inputs and unipolar gain control for ease of use. Added flexibility is achieved with a user-determined gain range and an external reference input that provide user-determined gain scaling (dB/V).

The high performance linear-in-dB response of the AD605 is achieved with the differential input, single-supply, exponential amplifier (DSX-AMP) architecture. Each of the DSX-AMPs comprises a variable attenuator of 0 dB to –48.4 dB followed by a high speed, fixed-gain amplifier. The attenuator is based on a 7-stage R-1.5R ladder network. The attenuation between tap points is 6.908 dB, and 48.360 dB for the entire ladder network. The DSX-AMP architecture results in 1.8 nV/ $\sqrt{\text{Hz}}$ input noise spectral density and accepts a ± 2.0 V input signal when V_{OCM} is biased at V_P/2.

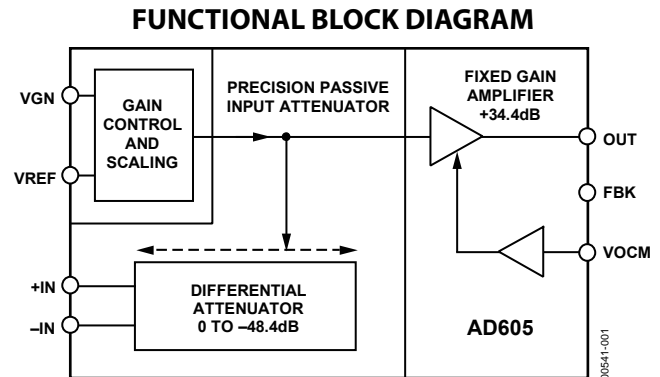

Figure 1.

Each independent channel of the AD605 provides a gain range of 48 dB that can be optimized for the application. Gain ranges between –14 dB to +34 dB and 0 dB to +48 dB can be selected by a single resistor between Pin FBK and Pin OUT. The lower and upper gain ranges are determined by shorting Pin FBK to Pin OUT or leaving Pin FBK unconnected, respectively. The two channels of the AD605 can be cascaded to provide 96 dB of very accurate gain range in a monolithic package.

The gain control interface provides an input resistance of approximately 2 M Ω and scale factors from 20 dB/V to 30 dB/V for a V_{REF} input voltage of 2.5 V to 1.67 V, respectively. Note that scale factors up to 40 dB/V are achievable with reduced accuracy for scales above 30 dB/V. The gain scales linearly in dB with control voltages (V_{GN}) of 0.4 V to 2.4 V for the 20 dB/V scale and 0.20 V to 1.20 V for the 40 dB/V scale. When V_{GN} is <50 mV, the amplifier is powered down to draw 1.9 mA. Under normal operation, the quiescent supply current of each amplifier channel is only 18 mA.

The AD605 is available in a 16-lead PDIP and a 16-lead SOIC_N package and is guaranteed for operation over the –40°C to +85°C temperature range.

Rev. E

Information furnished by Analog Devices is believed to be accurate and reliable. However, no responsibility is assumed by Analog Devices for its use, nor for any infringements of patents or other rights of third parties that may result from its use. Specifications subject to change without notice. No license is granted by implication or otherwise under any patent or patent rights of Analog Devices. Trademarks and registered trademarks are the property of their respective owners.

TABLE OF CONTENTS

Features 1
 Applications 1
 Functional Block Diagram 1
 General Description 1
 Revision History 2
 Specifications 3
 Absolute Maximum Ratings 5
 ESD Caution 5
 Pin Configuration and Function Descriptions 6
 Typical Performance Characteristics (per Channel) 7
 Theory of Operation 13

Differential Ladder (Attenuator) 14
 AC Coupling 14
 Gain Control Interface 14
 Fixed Gain Amplifier and Interpolator Circuits—Applying an Active Feedback Amplifier 15
 Applications Information 16
 Connecting Two Amplifiers to Double the Gain Range 16
 Outline Dimensions 18
 Ordering Guide 19

REVISION HISTORY

5/07—Rev. D to Rev. E

Changes to Table 1 5
 Changes to Fixed Gain Amplifier and Interpolator Circuits—Applying an Active Feedback Amplifier Section 15
 Updated Outline Dimensions 18
 Changes to Ordering Guide 19

1/06—Rev. C to Rev. D

Updated Format Universal
 Changes to Table 2 5
 Changes to Differential Ladder (Attenuator) Section 14
 Updated the Outline Dimensions 18
 Changes to the Ordering Guide 19

7/04—Rev. B to Rev. C

Edits to General Description 1
 Edits to Specifications 2
 Edits to Ordering Guide 3
 Change to TPC 22 6
 Updated Outline Dimensions 12

SPECIFICATIONS

Each channel @ $T_A = 25^\circ\text{C}$, $V_S = 5\text{ V}$, $R_S = 50\ \Omega$, $R_L = 500\ \Omega$, $C_L = 5\text{ pF}$, $V_{REF} = 2.5\text{ V}$ (scaling = 20 dB/V), -14 dB to +34 dB gain range, unless otherwise noted.

Table 1.

Parameter	Conditions	AD605A			AD605B			Unit
		Min	Typ	Max	Min	Typ	Max	
INPUT CHARACTERISTICS								
Input Resistance		175 ± 40			175 ± 40			Ω
Input Capacitance		3.0			3.0			pF
Peak Input Voltage	At minimum gain	2.5 ± 2.5			2.5 ± 2.5			V
Input Voltage Noise	VGN = 2.9 V	1.8			1.8			nV/√Hz
Input Current Noise	VGN = 2.9 V	2.7			2.7			pA/√Hz
Noise Figure	$R_S = 50\ \Omega$, $f = 10\text{ MHz}$, VGN = 2.9 V	8.4			8.4			dB
	$R_S = 200\ \Omega$, $f = 10\text{ MHz}$, VGN = 2.9 V	12			12			dB
Common-Mode Rejection Ratio	$f = 1\text{ MHz}$, VGN = 2.65 V	-20			-20			dB
OUTPUT CHARACTERISTICS								
-3 dB Bandwidth	Constant with gain	40			40			MHz
Slew Rate	VGN = 1.5 V, Output = 1 V step	170			170			V/μs
Output Signal Range	$R_L \geq 500\ \Omega$	2.5 ± 1.5			2.5 ± 1.5			V
Output Impedance	$f = 10\text{ MHz}$	2			2			Ω
Output Short-Circuit Current		±40			±40			mA
Harmonic Distortion	VGN = 1 V, $V_{OUT} = 1\text{ V p-p}$							
HD2	$f = 1\text{ MHz}$	-64			-64			dBc
HD3	$f = 1\text{ MHz}$	-68			-68			dBc
HD2	$f = 10\text{ MHz}$	-51			-51			dBc
HD3	$f = 10\text{ MHz}$	-53			-53			dBc
Two-Tone Intermodulation Distortion (IMD)	$R_S = 0\ \Omega$, VGN = 2.9 V, $V_{OUT} = 1\text{ V p-p}$							
	$f = 1\text{ MHz}$	-72			-72			dBc
	$f = 10\text{ MHz}$	-60			-60			dBc
1 dB Compression Point	$f = 10\text{ MHz}$, VGN = 2.9 V, output referred	15			15			dBm
Third-Order Intercept	$f = 10\text{ MHz}$, VGN = 2.9 V, $V_{OUT} = 1\text{ V p-p}$, input referred	-1			-1			dBm
Channel-to-Channel Crosstalk	Ch1: VGN = 2.65 V, inputs shorted, Ch2: VGN = 1.5 V (mid gain), $f = 1\text{ MHz}$, $V_{OUT} = 1\text{ V p-p}$	-70			-70			dB
Group Delay Variation	1 MHz < f < 10 MHz, full gain range	±2.0			±2.0			ns
VOCM Input Resistance		45			45			kΩ
ACCURACY								
Absolute Gain Error								
-14 dB to -11 dB	0.25 V < VGN < 0.40 V	-1.2	+1.0	+3.0	-1.2	+0.75	+3.0	dB
-11 dB to +29 dB	0.40 V < VGN < 2.40 V	-1.0	±0.3	+1.0	-1.0	±0.2	+1.0	dB
+29 dB to +34 dB	2.40 V < VGN < 2.65 V	-3.5	-1.25	+1.2	-3.5	-1.25	+1.2	dB
Gain Scaling Error	0.4 V < VGN < 2.4 V	±0.25			±0.25			dB/V
Output Offset Voltage	$V_{REF} = 2.500\text{ V}$, VOVM = 2.500 V	-30	±20	+30	-30	±20	+30	mV
Output Offset Variation	$V_{REF} = 2.500\text{ V}$, VOVM = 2.500 V	30		57	30		50	mV

AD605

Parameter	Conditions	AD605A			AD605B			Unit
		Min	Typ	Max	Min	Typ	Max	
GAIN CONTROL INTERFACE								
Gain Scaling Factor	VREF = 2.5 V, 0.4 V < VGN < 2.4 V	19	20	21	19	20	21	dB/V
	VREF = 1.67 V		30			30		dB/V
Gain Range	FBK short to OUT		-14 to +34			-14 to +34		dB
	FBK open		0 to 48			0 to 48		dB
Input Voltage (VGN) Range	20 dB/V, VREF = 2.5 V		0.1 to 2.9			0.1 to 2.9		V
Input Bias Current			-0.4			-0.4		μA
Input Resistance			2			2		MΩ
Response Time	48 dB gain change		0.2			0.2		μs
POWER SUPPLY								
Supply Voltage		4.5	5.0	5.5	4.5	5.0	5.5	V
Power Dissipation			90			90		mW
VREF Input Resistance			10			10		kΩ
Quiescent Supply Current	VPOS		18	23		18	23	mA
Power-Down	VPOS, VGN < 50 mV		1.9	3.0		1.9	3.0	mA
Power-Up Response Time	48 dB gain, V _{OUT} = 2 V p-p		0.6			0.6		μs
Power-Down Response Time			0.4			0.4		μs

ABSOLUTE MAXIMUM RATINGS

Table 2.

Parameter	Rating
Supply Voltage +V _S Pin 12, Pin 13 (with Pin 4, Pin 5 = 0 V)	6.5 V
Input Voltage Pin 1 to Pin 3, Pin 6 to Pin 9, Pin 16	VPOS, 0 V
Internal Power Dissipation	
16-Lead PDIP	1.4 W
16-Lead SOIC_N	1.2 W
Operating Temperature Range	−40°C to +85°C
Storage Temperature Range	−65°C to +150°C
Lead Temperature, Soldering 60 sec	300°C
Thermal Resistance θ_{JA}	
16-Lead PDIP	85°C/W
16-Lead SOIC_N	100°C/W

Stresses above those listed under Absolute Maximum Ratings may cause permanent damage to the device. This is a stress rating only; functional operation of the device at these or any other conditions above those indicated in the operational section of this specification is not implied. Exposure to absolute maximum rating conditions for extended periods may affect device reliability.

ESD CAUTION



ESD (electrostatic discharge) sensitive device. Charged devices and circuit boards can discharge without detection. Although this product features patented or proprietary protection circuitry, damage may occur on devices subjected to high energy ESD. Therefore, proper ESD precautions should be taken to avoid performance degradation or loss of functionality.

PIN CONFIGURATION AND FUNCTION DESCRIPTIONS

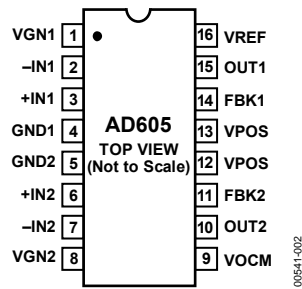

Figure 2. Pin Configuration

Table 3. Pin Function Descriptions

Pin No.	Mnemonic	Description
1	VGN1	CH1 Gain-Control Input and Power-Down Pin. If grounded, device is off; otherwise, positive voltage increases gain.
2	-IN1	CH1 Negative Input.
3	+IN1	CH1 Positive Input.
4	GND1	Ground.
5	GND2	Ground.
6	+IN2	CH2 Positive Input.
7	-IN2	CH2 Negative Input.
8	VGN2	CH2 Gain-Control Input and Power-Down Pin. If grounded, device is off; otherwise, positive voltage increases gain.
9	VOCM	Input to This Pin Defines Common-Mode Voltage for OUT1 and OUT2.
10	OUT2	CH2 Output.
11	FBK2	Feedback Pin That Selects Gain Range of CH2.
12	VPOS	Positive Supply.
13	VPOS	Positive Supply.
14	FBK1	Feedback Pin That Selects Gain Range of CH1.
15	OUT1	CH1 Output.
16	VREF	Input to This Pin Sets Gain Scaling for Both Channels: 2.5 V = 20 dB/V and 1.67 V = 30 dB/V.

TYPICAL PERFORMANCE CHARACTERISTICS (PER CHANNEL)

$V_{REF} = 2.5\text{ V}$ (20 dB/V scaling), $f = 1\text{ MHz}$, $R_L = 500\ \Omega$, $C_L = 5\text{ pF}$, $T_A = 25^\circ\text{C}$, $V_{SS} = 5\text{ V}$.

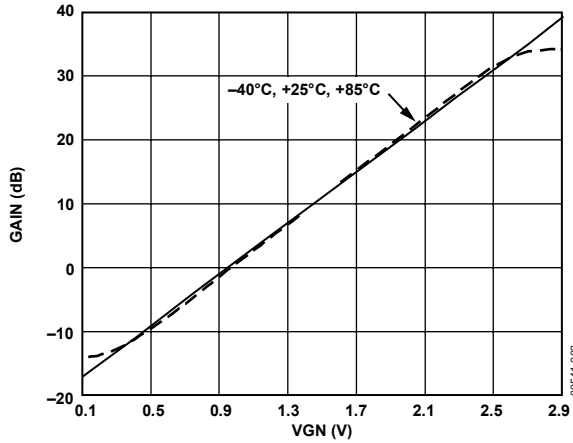

Figure 3. Gain vs. VGN

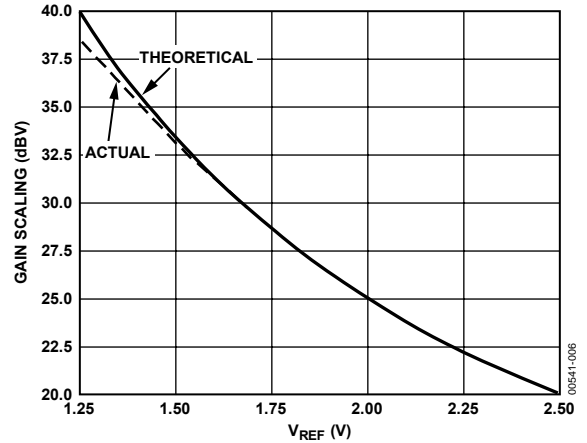

Figure 6. Gain Scaling vs. V_{REF}

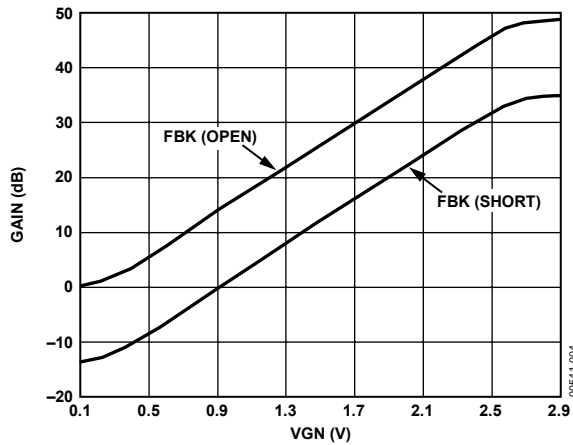

Figure 4. Gain vs. VGN for Different Gain Ranges

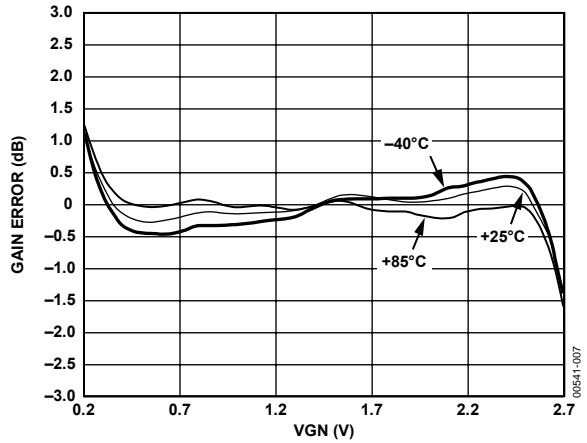

Figure 7. Gain Error vs. VGN at Three Temperatures

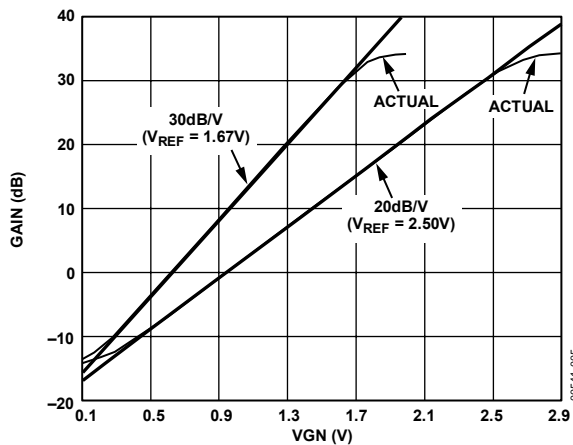

Figure 5. Gain vs. VGN for Different Gain Scalings

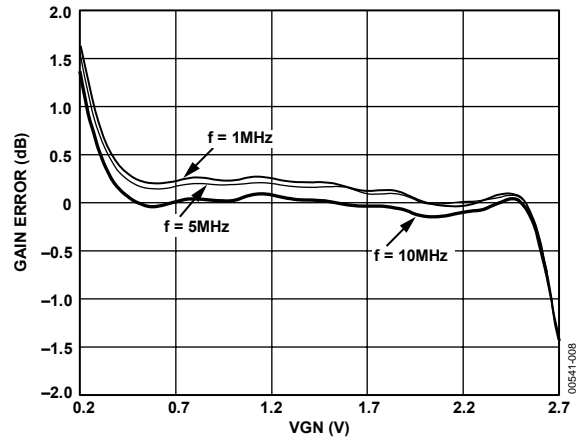

Figure 8. Gain Error vs. VGN at Three Frequencies

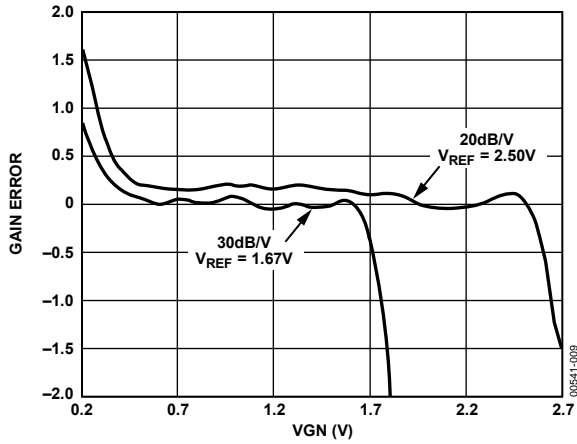

Figure 9. Gain Error vs. VGN for Two Gain Scale Values

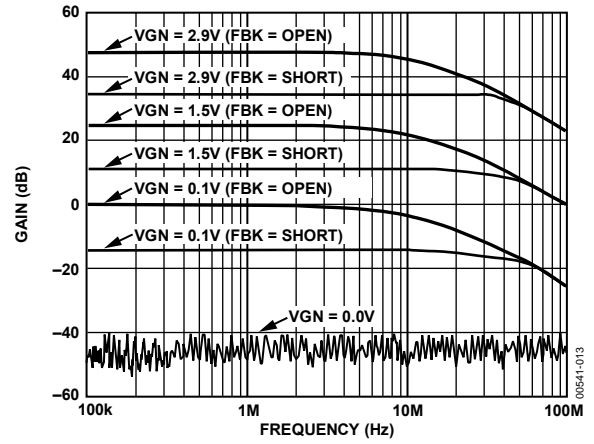

Figure 12. AC Response for Three Values of VGN

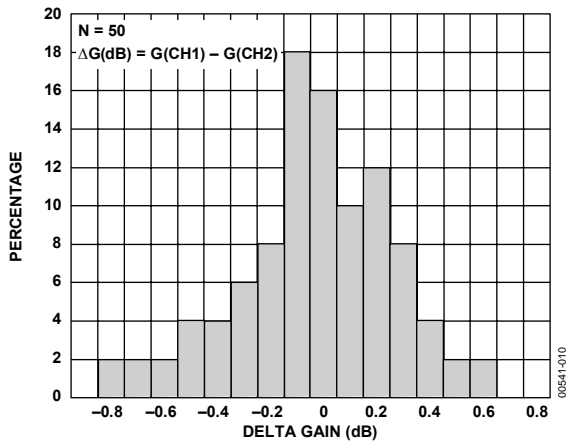

Figure 10. Gain Match, VGN1 = VGN2 = 1.0 V

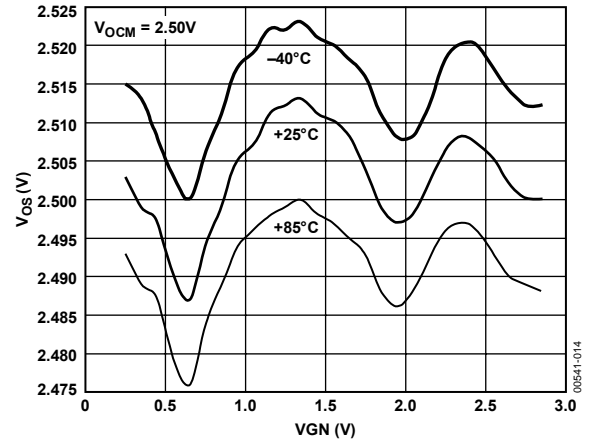

Figure 13. Output Offset vs. VGN at Three Temperatures

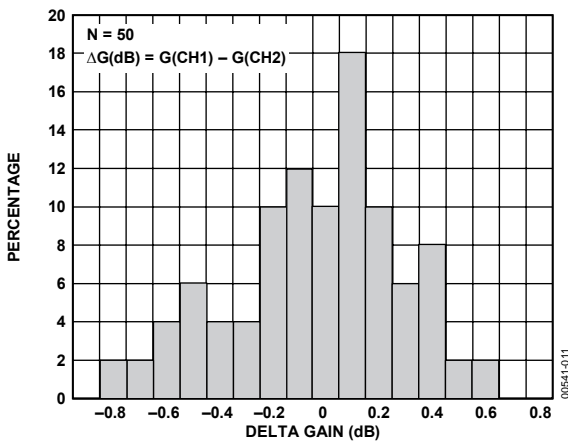

Figure 11. Gain Match, VGN1 = VGN2 = 2.50 V

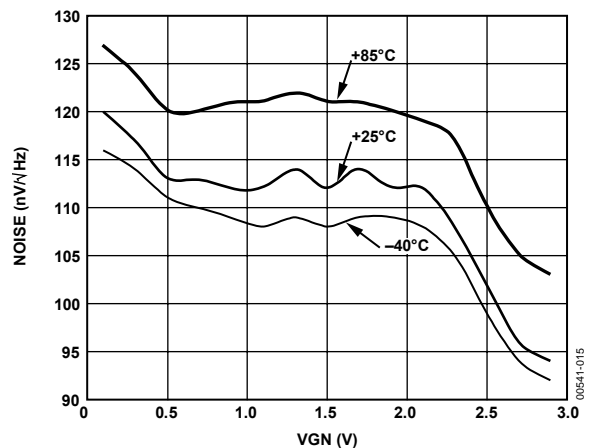

Figure 14. Output Referred Noise vs. VGN at Three Temperatures

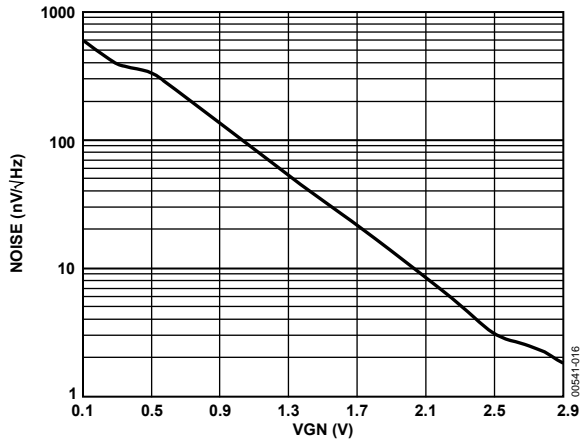

Figure 15. Input Referred Noise vs. VGN

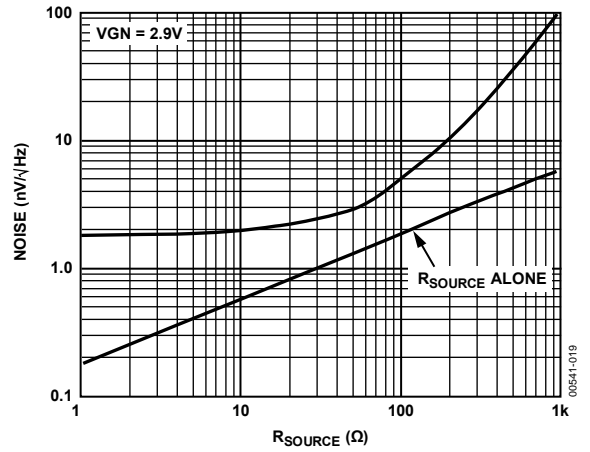

Figure 18. Input Referred Noise vs. R_{SOURCE}

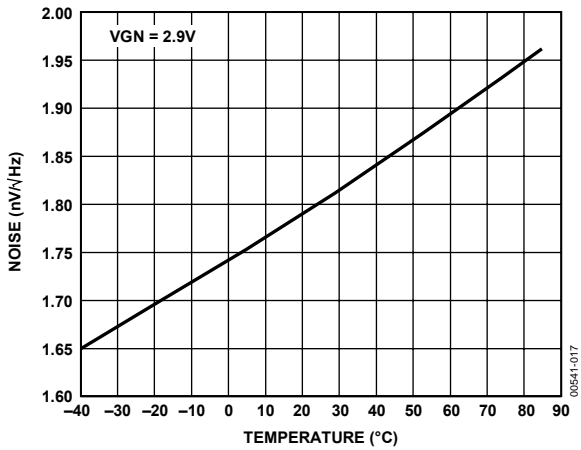

Figure 16. Input Referred Noise vs. Temperature

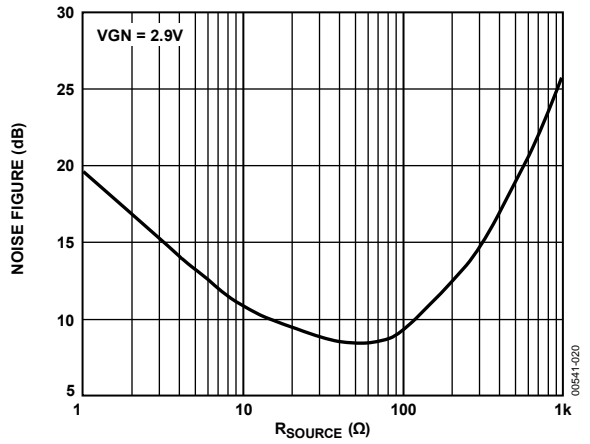

Figure 19. Noise Figure vs. R_{SOURCE}

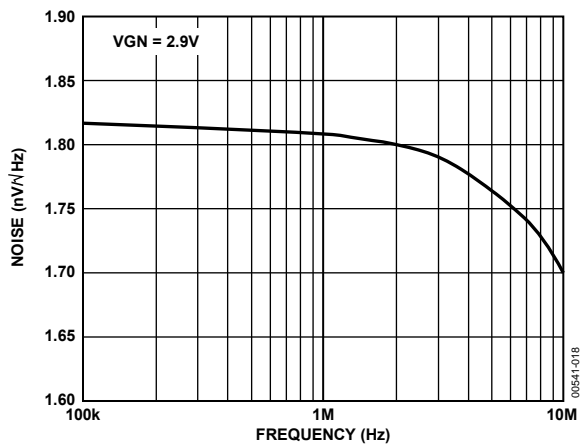

Figure 17. Input Referred Noise vs. Frequency

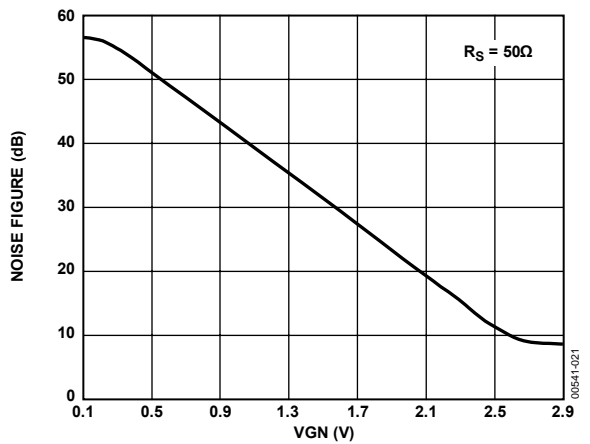

Figure 20. Noise Figure vs. VGN

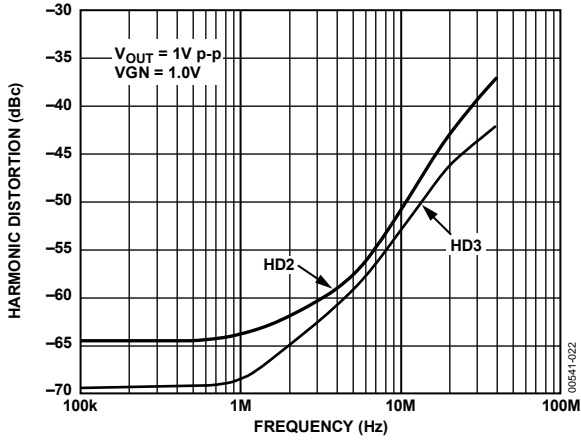

Figure 21. Harmonic Distortion vs. Frequency

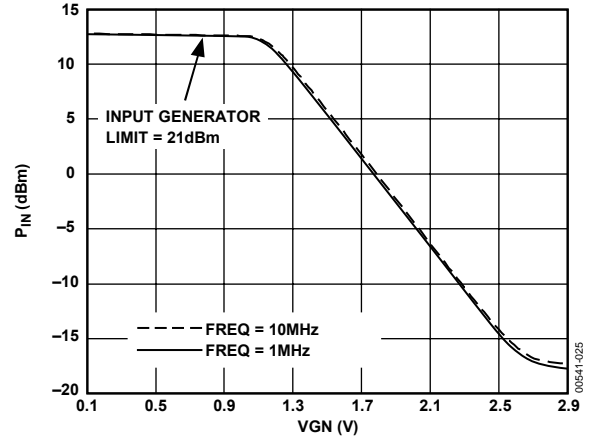

Figure 24. 1 dB Compression vs. VGN

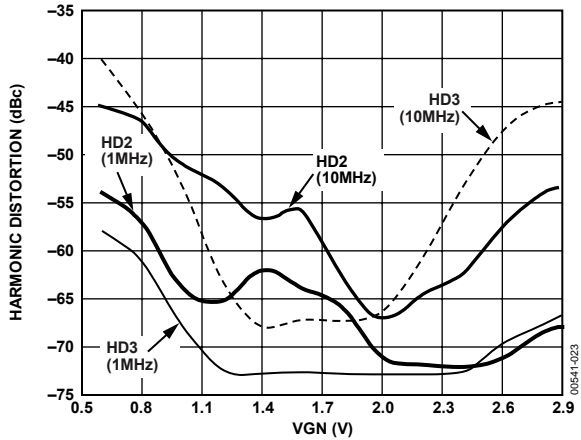

Figure 22. Harmonic Distortion vs. VGN at 1 MHz and 10 MHz

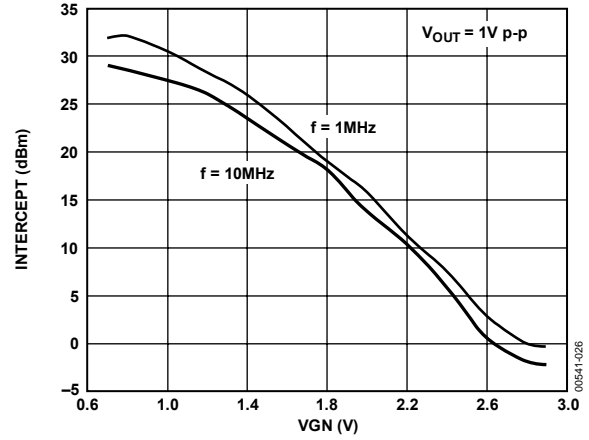

Figure 25. Third-Order Intercept vs. VGN at 1 MHz and 10 MHz

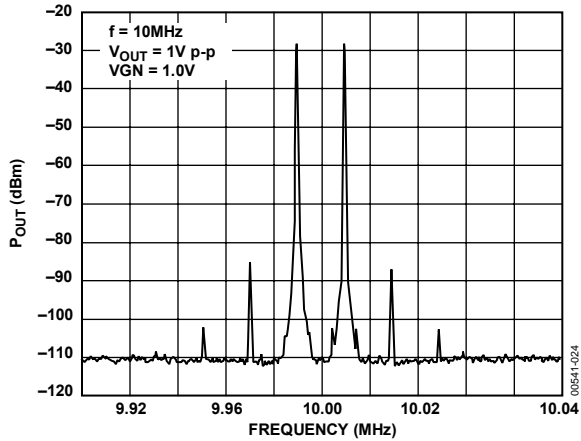

Figure 23. Intermodulation Distortion

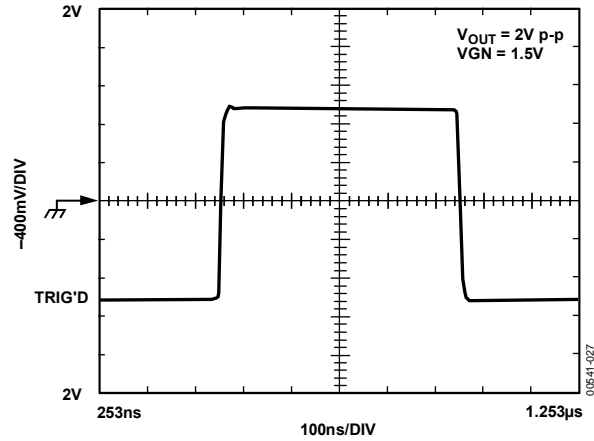

Figure 26. Large Signal Pulse Response

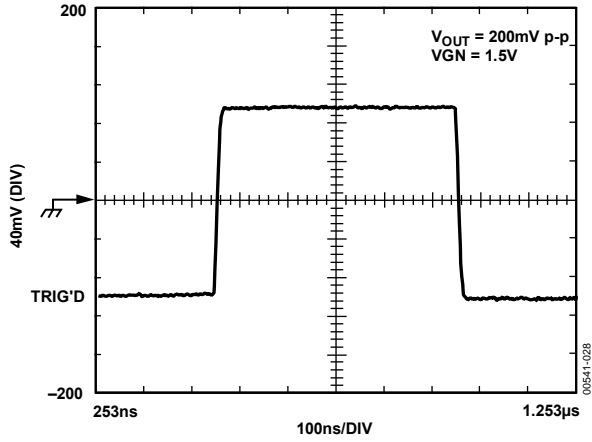

Figure 27. Small Signal Pulse Response

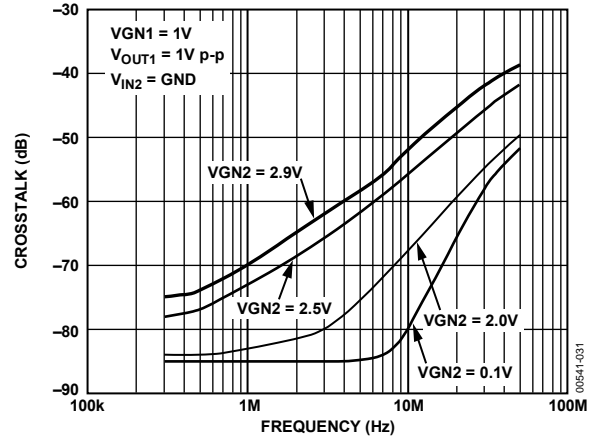

Figure 30. Crosstalk (CH1 to CH2) vs. Frequency for Four Values of VGN2

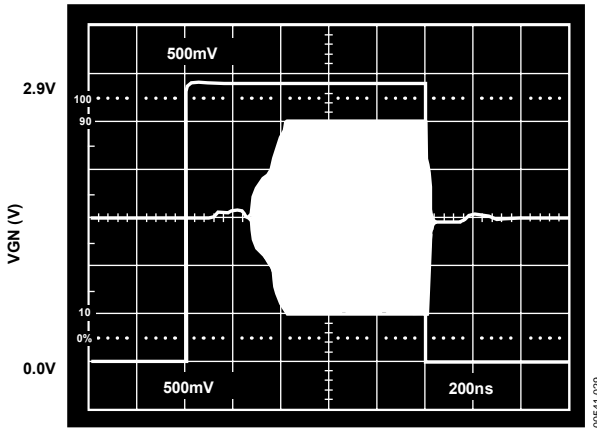

Figure 28. Power-Up/Power-Down Response

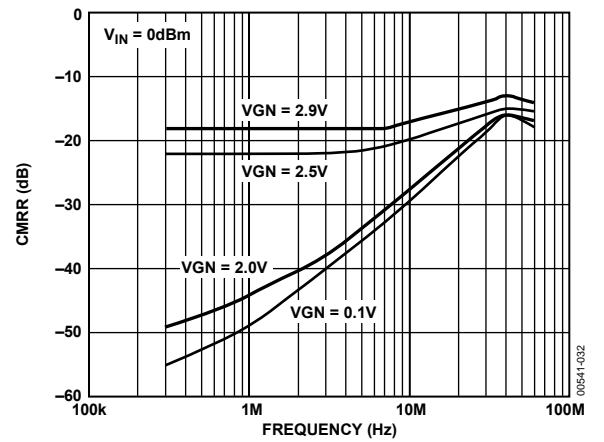

Figure 31. Common-Mode Rejection Ratio (CMRR) vs. Frequency for Four Values of VGN

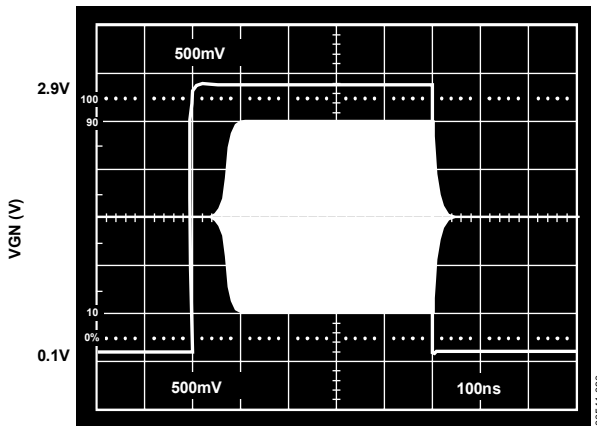

Figure 29. Gain Response

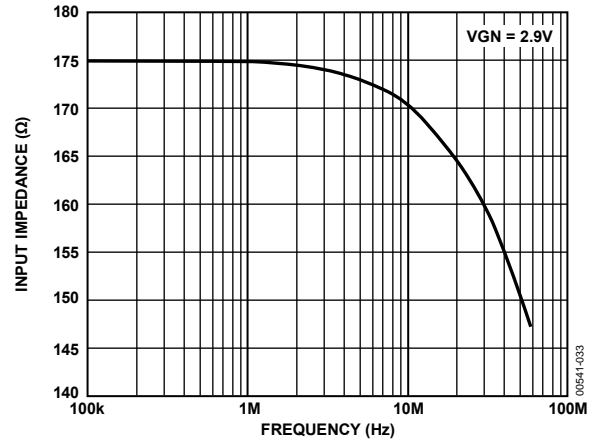

Figure 32. Input Impedance vs. Frequency

AD605

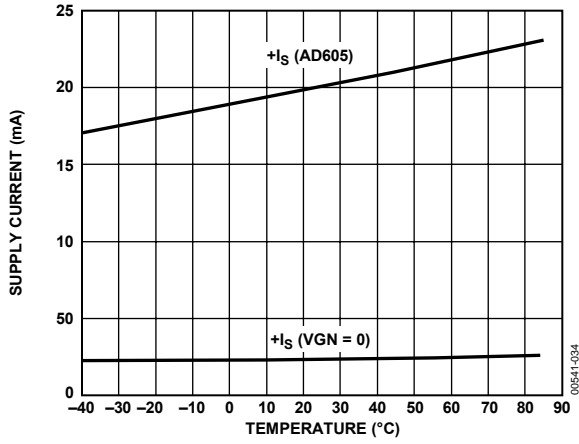

Figure 33. Supply Current (One Channel) vs. Temperature

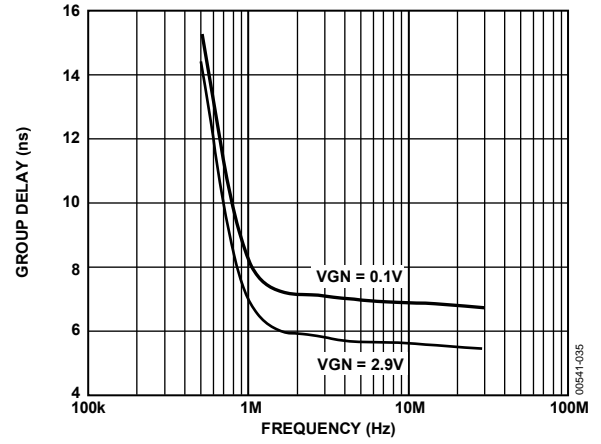

Figure 34. Group Delay vs. Frequency

THEORY OF OPERATION

The AD605 is a dual-channel, low noise VGA. Figure 35 shows the simplified block diagram of one channel. Each channel consists of a single-supply X-AMP[®] (hereafter called DSX, differential single-supply X-AMP) comprising:

- Precision passive attenuator (differential ladder)
- Gain control block
- VOCM buffer with supply splitting resistors R3 and R4
- Active feedback amplifier¹ (AFA) with gain setting resistors R1 and R2

The linear-in-dB gain response of the AD605 can generally be described by Equation 1.

$$G \text{ (dB)} = (\text{Gain Scaling (dB/V)}) \times (\text{Gain Control (V)}) - (19 \text{ dB} - (14 \text{ dB}) \times (FB)) \quad (1)$$

where:

$FB = 0$, if FBK to OUT is shorted.

$FB = 1$, if FBK to OUT is open.

Each channel provides between -14 dB to $+34.4 \text{ dB}$ through 0 dB to $+48.4 \text{ dB}$ of gain, depending on the value of the resistance connected between Pin FBK and Pin OUT. The center 40 dB of gain is exactly linear-in-dB while the gain error increases at the top and bottom of the range. The gain is set by the gain control voltage (VGN). The VREF input establishes the gain scaling. The useful gain scaling range is between 20 dB/V and 40 dB/V for a VREF voltage of 2.5 V and 1.25 V , respectively. For example, if FBK to OUT were shorted and VREF were set to 2.50 V (to establish a gain scaling of 20 dB/V), the gain equation would simplify to

$$G \text{ (dB)} = (20 \text{ (dB/V)}) \times (\text{VGN (V)}) - 19 \text{ dB} \quad (2)$$

The desired gain can then be achieved by setting the unipolar gain control (VGN) to a voltage within its nominal operating range of 0.25 V to 2.65 V (for 20 dB/V gain scaling). The gain is monotonic for a complete gain control range of 0.1 V to 2.9 V . Maximum gain can be achieved at a VGN of 2.9 V .

Because the two channels are identical, only Channel 1 is used to describe their operation. VREF and VOCM are the only inputs that are shared by the two channels, and because they are normally ac grounds, crosstalk between the two channels is minimized. For the highest gain scaling accuracy, VREF should have an external low impedance voltage source. For low accuracy 20 dB/V applications, the VREF input can be decoupled with a capacitor to ground. In this mode, the gain scaling is determined by the midpoint between $+VCC$ and GND; therefore, care should be taken to control the supply voltage to 5 V . The input resistance looking into the VREF pin is $10 \text{ k}\Omega \pm 20\%$.

The AD605 is a single-supply circuit, and the VOCM pin is used to establish the dc level of the midpoint of this portion of the circuit. VOCM needs only an external decoupling capacitor to ground to center the midpoint between the supply voltages (5 V , GND). However, if the dc level of the output is important to the user (see the Applications section of the [AD9050](#) data sheet for an example), VOCM can be specifically set. The input resistance looking into the VOCM pin is $45 \text{ k}\Omega \pm 20\%$.

¹ To understand the active-feedback amplifier topology, refer to the [AD830](#) data sheet. The AD830 is a practical implementation of the idea.

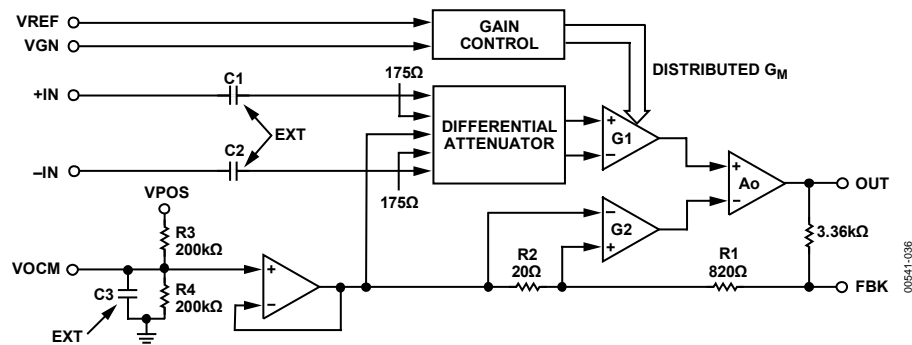

Figure 35. Simplified Block Diagram of a Single Channel of the AD605

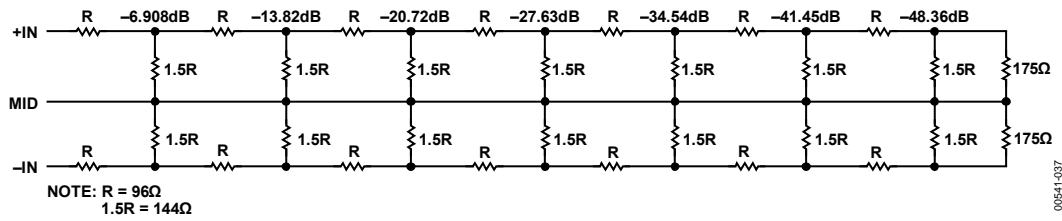

Figure 36. R-1.5R Dual Ladder Network

DIFFERENTIAL LADDER (ATTENUATOR)

The attenuator before the fixed gain amplifier is realized by a differential, 7-stage, R-1.5R resistive ladder network with an untrimmed input resistance of 175 Ω single-ended or 350 Ω differentially. The signal applied at the input of the ladder network is attenuated by 6.908 dB per tap; therefore, the attenuation at the first tap is 6.908 dB, at the second, 13.816 dB, and so on all the way to the last tap where the attenuation is 48.356 dB (see Figure 36). A unique circuit technique is used to interpolate continuously between the tap points, thereby providing continuous attenuation from 0 dB to -48.36 dB. One can think of the ladder network together with the interpolation mechanism as a voltage-controlled potentiometer.

Because the DSX is a single-supply circuit, some means of biasing its inputs must be provided. Node MID together with the VOVM buffer performs this function. Without internal biasing, external biasing is required. If not done carefully, the biasing network can introduce additional noise and offsets. By providing internal biasing, the user is relieved of this task and only needs to ac couple the signal into the DSX. It should be made clear again that the input to the DSX is still fully differential if driven differentially, that is, Pin +IN and Pin -IN see the same signal but with opposite polarity. What changes is the load as seen by the driver; it is 175 Ω when each input is driven single-ended, but 350 Ω when driven differentially. This can be easily explained when thinking of the ladder network as two 175 Ω resistors connected back-to-back with the middle node, MID, being biased by the VOVM buffer. A differential signal applied between nodes +IN and -IN results in zero current into node MID, but a single-ended signal applied to either input +IN or -IN, while the other input is ac grounded, causes the current delivered by the source to flow into the VOVM buffer via node MID.

A feature of the X-AMP architecture is that the output-referred noise is constant vs. gain over most of the gain range. Referring to Figure 36, the tap resistance is approximately equal for all taps within the ladder, excluding the end sections. The resistance seen looking into each tap is 54.4 Ω , which makes 0.95 nV/ $\sqrt{\text{Hz}}$ of Johnson noise spectral density. Because there are two attenuators, the overall noise contribution of the ladder network is $\sqrt{2}$ times 0.95 nV/ $\sqrt{\text{Hz}}$ or 1.34 nV/ $\sqrt{\text{Hz}}$, a large fraction of the total DSX noise. The rest of the DSX circuit components contribute another 1.20 nV/ $\sqrt{\text{Hz}}$, which together with the attenuator produces 1.8 nV/ $\sqrt{\text{Hz}}$ of total DSX input referred noise.

AC COUPLING

The DSX is a single-supply circuit; therefore, its inputs need to be ac-coupled to accommodate ground-based signals. External Capacitor C1 and Capacitor C2 in Figure 35 level-shift the input signal from ground to the dc value established by VOVM (nominal 2.5 V). C1 and C2, together with the 175 Ω looking into each of DSX inputs (+IN and -IN), act as high-pass filters with corner frequencies depending on the values chosen for C1 and C2. For example, if C1 and C2 are 0.1 μF , together with the 175 Ω input resistance of each side of the differential ladder of the DSX, a -3 dB high-pass corner at 9.1 kHz is formed.

If the DSX output needs to be ground referenced, another ac coupling capacitor is required for level shifting. This capacitor also eliminates any dc offsets contributed by the DSX. With a nominal load of 500 Ω and a 0.1 μF coupling capacitor, this adds a high-pass filter with -3 dB corner frequency at about 3.2 kHz.

The choice for all three of these coupling capacitors depends on the application. They should allow the signals of interest to pass unattenuated, while at the same time, they can be used to limit the low frequency noise in the system.

GAIN CONTROL INTERFACE

The gain control interface provides an input resistance of approximately 2 M Ω at Pin VGN1 and gain scaling factors from 20 dB/V to 40 dB/V for VREF input voltages of 2.5 V to 1.25 V, respectively. The gain varies linearly in dB for the center 40 dB of gain range, that is, for VGN equal to 0.4 V to 2.4 V for the 20 dB/V scale and 0.25 V to 1.25 V for the 40 dB/V scale. Figure 37 shows the ideal gain curves when the FBK-to-OUT connection is shorted as described by the following equations:

$$G (20 \text{ dB/V}) = 20 \times VGN - 19, V_{REF} = 2.500 \text{ V} \quad (3)$$

$$G (30 \text{ dB/V}) = 30 \times VGN - 19, V_{REF} = 1.6666 \text{ V} \quad (4)$$

$$G (40 \text{ dB/V}) = 40 \times VGN - 19, V_{REF} = 1.250 \text{ V} \quad (5)$$

From the equations, one can see that all gain curves intercept at the same -19 dB point; this intercept is 14 dB higher (-5 dB) if the FBK-to-OUT connection is left open. Outside the central linear range, the gain starts to deviate from the ideal control law but still provides another 8.4 dB of range. For a given gain scaling, one can calculate V_{REF} as

$$V_{REF} = \frac{2.500 \text{ V} \times 20 \text{ dB/V}}{\text{Gain Scale}} \quad (6)$$

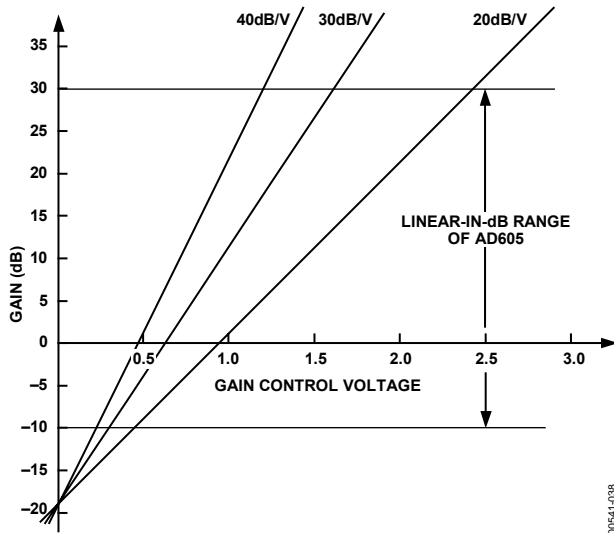

Figure 37. Ideal Gain Curves vs. V_{REF}

Usable gain control voltage ranges are 0.1 V to 2.9 V for the 20 dB/V scale and 0.1 V to 1.45 V for the 40 dB/V scale. VGN voltages of less than 0.1 V are not used for gain control because below 50 mV the channel is powered down. This can be used to conserve power and at the same time gate-off the signal. The supply current for a powered-down channel is 1.9 mA, and the response time to power the device on or off is less than 1 μ s.

FIXED GAIN AMPLIFIER AND INTERPOLATOR CIRCUITS—APPLYING AN ACTIVE FEEDBACK AMPLIFIER

A typical X-amp architecture is powered by a dual polarity power supply. Because the AD605 operates from a single-supply, a supply-common equal to half the value of the supply voltage is required. An active feedback amplifier (AFA) is used to provide a differential input and to implement the feedback loop. The AFA in the AD605 is an op amp with two g_m stages, one is used in the feedback path and the other is used as a highly linear differential input.

A multisection distributed g_m stage senses the voltages on the ladder network, one stage for each of the ladder nodes. Only a few of the stages are active at any time and are dependent on the gain control voltage.

The AFA makes a differential input structure possible because one of its inputs (G1) is fully differential; this input is made up of a distributed g_m stage. The second input (G2) is used for feedback. The output of G1 is some function of the voltages sensed on the attenuator taps that is applied to a high-gain amplifier (A0). Because of negative feedback, the differential input to the high gain amplifier is zero; this in turn implies that the differential input voltage to G2 times g_{m2} (the transconductance of G2) is equal to the differential input voltage to G1 times g_{m1} (the transconductance of G1). Therefore, the overall gain function of the AFA is

$$\frac{V_{OUT}}{V_{ATTEN}} = \frac{g_{m1}}{g_{m2}} \times \frac{R1 \times R2}{R2} \quad (7)$$

where:

V_{OUT} is the output voltage.

V_{ATTEN} is the effective voltage sensed on the attenuator.

$$(R1 + R2)/R2 = 42.$$

$g_{m1}/g_{m2} = 1.25$; the overall gain is therefore 52.5 (34.4 dB).

The AFA has additional features: inverting the output signal by switching the positive and negative input to the ladder network; the possibility of using the $-IN$ input as a second signal input; and independent control of the DSX common-mode voltage.

Under normal operating conditions, it is best to connect a decoupling capacitor to Pin VOCM, in which case, the common-mode voltage of the DSX is half of the supply voltage; this allows for maximum signal swing. Nevertheless, the common-mode voltage can be shifted up or down by directly applying a voltage to VOCM. It can also be used as another signal input, the only limitation being the rather low slew rate of the VOCM buffer.

If the dc level of the output signal is not critical, another coupling capacitor is normally used at the output of the DSX; again, this is done for level shifting and to eliminate any dc offsets contributed by the DSX (see the AC Coupling section).

The gain range of the DSX is programmable by a resistor connected between Pin FBK and Pin OUT. The possible ranges are -14 dB to $+34.4$ dB when the pins are shorted together or 0 dB to $+48.4$ dB when FBK is left open. Note that for the higher gain range, the bandwidth of the amplifier is reduced by a factor of five to about 8 MHz because the gain increased by 14 dB. This is the case for any constant gain bandwidth product amplifier that includes the active feedback amplifier.

APPLICATIONS INFORMATION

The basic circuit in Figure 38 shows the connections for one channel of the AD605 with a gain range of -14 dB to $+34.4$ dB. The signal is applied at Pin 3. The ac coupling capacitors before Pin $-IN1$ and Pin $+IN1$ should be selected according to the required lower cutoff frequency. In this example, the 0.1 μ F capacitors, together with the 175 Ω of each of the DSX input pins, provide a -3 dB high-pass corner of about 9.1 kHz. The upper cutoff frequency is determined by the amplifier and is 40 MHz.

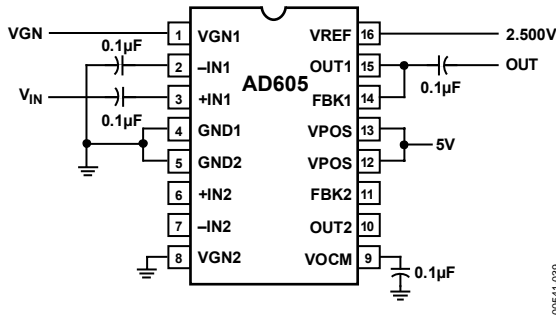

Figure 38. Basic Connections for a Single Channel

As shown in Figure 38, the output is ac-coupled for optimum performance. In the case of connecting to the 10-bit, 40 MS/PS ADC, [AD9050](#), ac coupling can be eliminated as long as Pin $VOCM$ is biased by the same 3.3 V common-mode voltage as the [AD9050](#).

Pin $VREF$ requires a voltage of 1.25 V to 2.5 V, with gain scaling between 40 dB/V and 20 dB/V, respectively. Voltage VGN controls the gain; its nominal operating range is from 0.25 V to 2.65 V for 20 dB/V gain scaling and 0.125 V to 1.325 V for 40 dB/V scaling. When this pin is taken to ground, the channel powers down and disables its output.

CONNECTING TWO AMPLIFIERS TO DOUBLE THE GAIN RANGE

Figure 39 shows the two channels of the AD605 connected in series to provide a total gain range of 96.8 dB. When $R1$ and $R2$ are shorts, the gain range is from -28 dB to $+68.8$ dB with a slightly reduced bandwidth of about 30 MHz. The reduction in bandwidth is due to two identical low-pass circuits being connected in series; in the case of two identical single-pole, low-pass filters, the bandwidth is reduced by exactly $\sqrt{2}$. If $R1$ and $R2$ are replaced by open circuits, that is, Pin $FBK1$ and Pin $FBK2$ are left unconnected, the gain range shifts up by 28 dB to 0 dB to 96.8 dB. As previously noted, the bandwidth of each individual channel is reduced by a factor of 5 to about 8 MHz because the gain increased by 14 dB. In addition, there is still the $\sqrt{2}$ reduction because of the series connection of the two channels that results in a final bandwidth of the higher gain version of about 6 MHz.

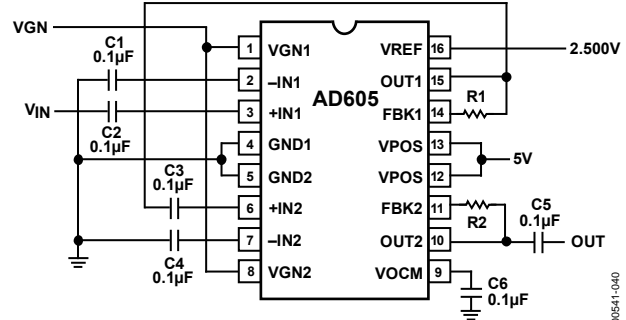

Figure 39. Doubling the Gain Range with Two Amplifiers

Two other easy combinations are possible to provide a gain range of -14 dB to $+82.8$ dB: make $R1$ a short and $R2$ an open, or make $R1$ an open and $R2$ a short. The bandwidth for both of these cases is dominated by the channel that is set to the higher gain and is about 8 MHz. From a noise standpoint, the second choice is the best because by increasing the gain of the first amplifier, the noise of the second amplifier has less of an impact on the total output noise. One further observation regarding noise is that by increasing the gain, the output noise increases proportionally; therefore, there is no increase in signal-to-noise ratio. It actually stays fixed.

It should be noted that by selecting the appropriate values of $R1$ and $R2$, any gain range between -28 dB to $+68.8$ dB and 0 dB to $+96.8$ dB can be achieved with the circuit in Figure 39. When using any value other than shorts and opens for $R1$ and $R2$, the final value of the gain range depends on the external resistors matching the on-chip resistors. Because the internal resistors can vary by as much as $\pm 20\%$, the actual values for a particular gain have to be determined empirically. Note that the two channels within one part match quite well; therefore, $R1$ tracks $R2$ in Figure 39.

$C3$ is not required because the common-mode voltage at Pin $OUT1$ should be identical to the one at Pin $+IN2$ and Pin $-IN2$. However, because only 1 mV of offset at the output of the first DSX introduces an offset of 53 mV when the second DSX is set to the maximum gain of the lowest gain range (34.4 dB), and 263 mV when set to the maximum gain of the highest gain range (48.4 dB), it is important to include ac coupling to get the maximum dynamic range at the output of the cascaded amplifiers. $C5$ is necessary if the output signal needs to be referenced to any common-mode level other than half of the supply as is provided by Pin $OUT2$.

Figure 40 shows the gain vs. VGN for the circuit in Figure 39 at 1 MHz and the lowest gain range (-14 dB to +34.4 dB). Note that the gain scaling is 40 dB/V, double the 20 dB/V of an individual DSX; this is the result of the parallel connection of the gain control inputs, VGN1 and VGN2. One could, of course, also sequentially increase the gain by first increasing the gain of Channel 1 and then Channel 2. In this case, VGN1 and VGN2 are driven from separate voltage sources, for instance two separate DACs. Figure 41 shows the gain error of Figure 39.

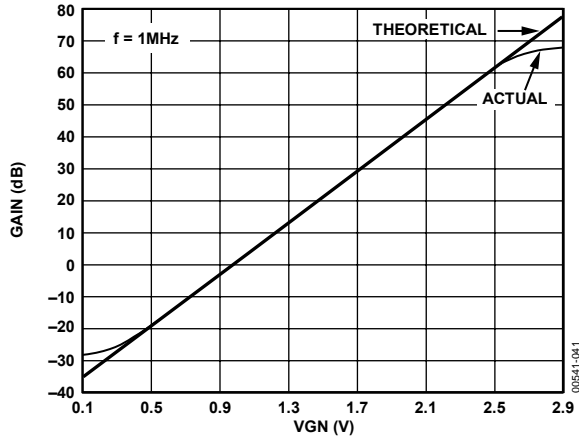

Figure 40. Gain vs. VGN for the Circuit in Figure 39

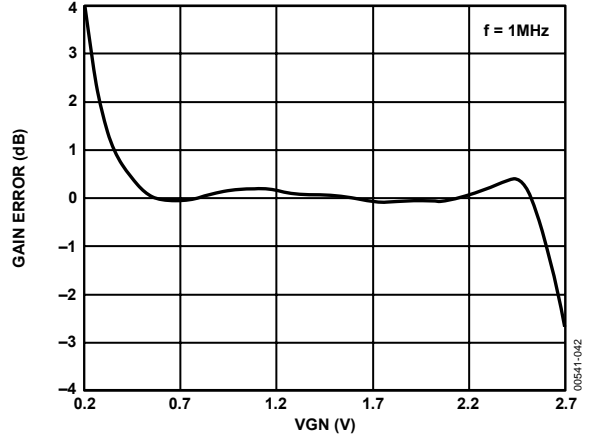
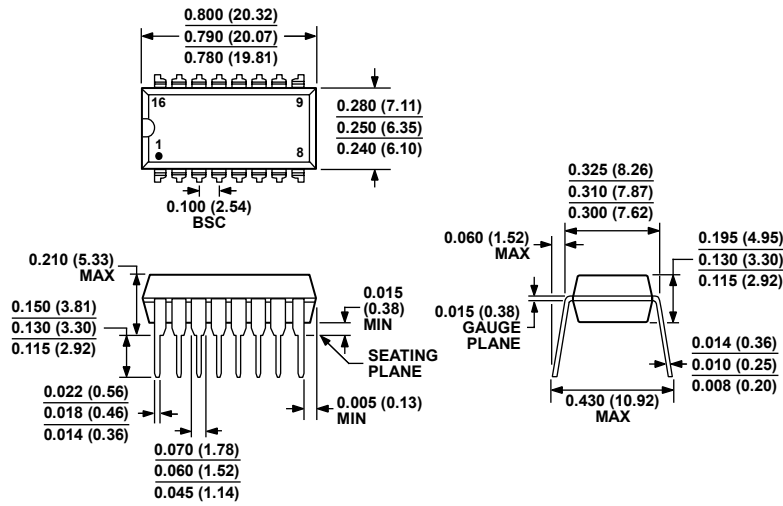

Figure 41. Gain Error vs. VGN for the Circuit in Figure 39

OUTLINE DIMENSIONS



COMPLIANT TO JEDEC STANDARDS MS-001-AB
 CONTROLLING DIMENSIONS ARE IN INCHES; MILLIMETER DIMENSIONS
 (IN PARENTHESES) ARE ROUNDED-OFF INCH EQUIVALENTS FOR
 REFERENCE ONLY AND ARE NOT APPROPRIATE FOR USE IN DESIGN.
 CORNER LEADS MAY BE CONFIGURED AS WHOLE OR HALF LEADS.

Figure 42. 16-Lead Plastic Dual In-Line Package [PDIP]
 (N-16)

Dimensions shown in inches and (millimeters)

073106-B

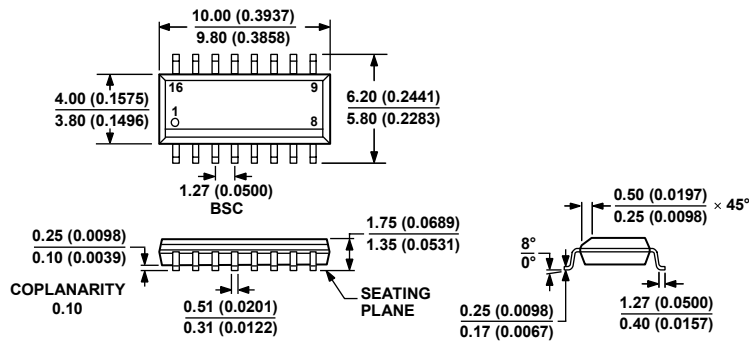

COMPLIANT TO JEDEC STANDARDS MS-012-AC
 CONTROLLING DIMENSIONS ARE IN MILLIMETERS; INCH DIMENSIONS
 (IN PARENTHESES) ARE ROUNDED-OFF MILLIMETER EQUIVALENTS FOR
 REFERENCE ONLY AND ARE NOT APPROPRIATE FOR USE IN DESIGN.

Figure 43. 16-Lead Standard Small Outline Package [SOIC_N]
 Narrow Body
 (R-16)

Dimensions shown in millimeters and (inches)

066606-A

ORDERING GUIDE

Model	Temperature Range	Package Description	Package Option
AD605AN	−40°C to +85°C	16-Lead PDIP	N-16
AD605ANZ ¹	−40°C to +85°C	16-Lead PDIP	N-16
AD605AR	−40°C to +85°C	16-Lead SOIC_N	R-16
AD605AR-REEL	−40°C to +85°C	16-Lead SOIC_N, 13" Reel	R-16
AD605AR-REEL7	−40°C to +85°C	16-Lead SOIC_N, 7" Reel	R-16
AD605ARZ ¹	−40°C to +85°C	16-Lead SOIC_N	R-16
AD605ARZ-RL ¹	−40°C to +85°C	16-Lead SOIC_N, 13" Reel	R-16
AD605ARZ-R7 ¹	−40°C to +85°C	16-Lead SOIC_N, 7" Reel	R-16
AD605BN	−40°C to +85°C	16-Lead PDIP	N-16
AD605BR	−40°C to +85°C	16-Lead SOIC_N	R-16
AD605BR-REEL	−40°C to +85°C	16-Lead SOIC_N, 13" Reel	R-16
AD605BR-REEL7	−40°C to +85°C	16-Lead SOIC_N, 7" Reel	R-16
AD605BRZ ¹	−40°C to +85°C	16-Lead SOIC_N	R-16
AD605BRZ-RL ¹	−40°C to +85°C	16-Lead SOIC_N, 13" Reel	R-16
AD605BRZ-R7 ¹	−40°C to +85°C	16-Lead SOIC_N, 7" Reel	R-16
AD605-EB		Evaluation Board	
AD605ACHIPS		DIE	

¹ Z = RoHS Compliant Part.

AD605

NOTES