

FEATURES

Low Input Bias Current: 1nA max (AD517L)
Low Input Offset Current: 0.25nA max (AD517L)
Low V_{OS} : 50 μ V max (AD517L), 150 μ V max (AD517J)
Low V_{OS} Drift: 1.3 μ V/ $^{\circ}$ C (AD517L)
 Internal Compensation
 MIL-Standard Parts Available
8-Pin TO-99 Hermetic Metal Can
 Available in Chip Form

PIN CONFIGURATION

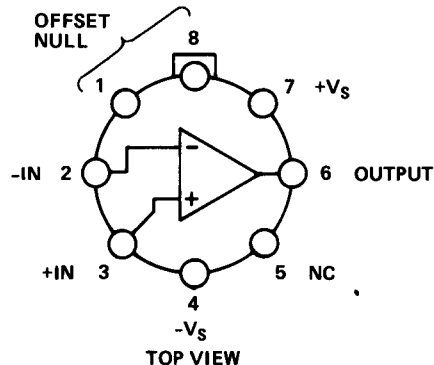

PRODUCT DESCRIPTION

The AD517 is a high accuracy monolithic op amp featuring extremely low offset voltages and input currents. Analog Devices' thermally-balanced layout and superior IC processing combine to produce a truly precision device at low cost.

The AD517 is laser trimmed at the wafer level (LWT) to produce offset voltages less than 50 μ V and offset voltage drifts less than 1.3 μ V/ $^{\circ}$ C unnullled. Superbeta input transistors provide extremely low input bias currents of 1nA max and offset currents as low as 0.25nA max. While these figures are comparable to presently available BIFET amplifiers at room temperature, the AD517 input currents decrease, rather than increase, at elevated temperatures. Open-loop gain in many IC amplifiers is degraded under loaded conditions due to thermal gradients on the chip. However, the AD517 layout is balanced along a thermal axis, maintaining open-loop gain in excess of 1,000,000 for a wide range of load resistances.

The input stage of the AD517 is fully protected, allowing differential input voltages of up to $\pm V_S$ without degradation of gain or bias current due to reverse breakdown. The output stage is short-circuit protected and is capable of driving a load capacitance up to 1000pF.

The AD517 is well suited to applications requiring high precision and excellent long-term stability at low cost, such as stable references, followers, bridge instruments and analog computation circuits.

The circuit is packaged in a hermetically sealed TO-99 metal can, and is available in three performance versions (J, K, and L) specified over the commercial 0 to +70 $^{\circ}$ C range; and one version (AD517S) specified over the extended temperature range, -55 $^{\circ}$ C to +125 $^{\circ}$ C.

PRODUCT HIGHLIGHTS

1. Offset voltage is 100% tested and guaranteed on all models.
2. The AD517 exhibits extremely low input bias currents without sacrificing CMRR (over 100dB) or offset voltage stability.
3. The AD517 inputs are protected (to $\pm V_S$), preventing offset voltage and bias current degradation due to reverse breakdown of the input transistors.
4. Internal compensation is provided, eliminating the need for additional components (often required by high accuracy IC op amps).
5. The AD517 can directly replace 725, 108, and AD510 amplifiers. In addition, it can replace 741-type amplifiers if the offset-nulling potentiometer is removed.
6. Thermally-balanced layout insures high open-loop gain independent of thermal gradients induced by output loading, offset nulling, and power supply variations.
7. Chips are available.

AD517—SPECIFICATIONS (@ +25°C and $V_S = \pm 15V$ dc)

Model	AD517J			AD517K			AD517L			AD517S			Units
	Min	Typ	Max	Min	Typ	Max	Min	Typ	Max	Min	Typ	Max	
OPEN LOOP GAIN $V_O = \pm 10V, R_L \geq 2k\Omega$ T_{min} to $T_{max}, R_L = 2k\Omega$	10⁶ 500,000			10⁶ 500,000			10⁶ 500,000			10⁶ 250,000			V/V V/V
OUTPUT CHARACTERISTICS Voltage @ $R_L = 2k\Omega, T_{min}$ to T_{max} Load Capacitance Output Current Short Circuit Current	± 10 1000 10 25			± 10 1000 10 25			± 10 1000 10 25			± 10 1000 10 25			V pF mA mA
FREQUENCY RESPONSE Unity Gain Small Signal Full Power Response Slew Rate, Unity Gain	250 1.5 0.10			250 1.5 0.10			250 1.5 0.10			250 1.5 0.10			kHz kHz V/ μ s
INPUT OFFSET VOLTAGE Initial Offset Input Offset vs. Temp. Input Offset vs. Supply T_{min} to T_{max}	150 3.0 25 40			75 1.8 10 15			50 1.3 10 15			75 1.8 10 20			μ V μ V/°C μ V/V μ V/V
INPUT BIAS CURRENT Initial T_{min} to T_{max} vs. Temp, T_{min} to T_{max}	5 8 ± 20			2 3.5 ± 10			1.0 1.5 ± 4			2.0 10 ± 10			nA nA pA/°C
INPUT OFFSET CURRENT Initial T_{min} to T_{max}	1.0 1.5			0.75 1.25			0.25 0.4			2.0 10			nA nA
INPUT IMPEDANCE Differential Common Mode	15 1.5 2.0 $\times 10^7$			20 1.5 2.0 $\times 10^7$			20 1.5 2.0 $\times 10^7$			20 1.5 2.0 $\times 10^7$			M Ω pF Ω
INPUT VOLTAGE RANGE Differential Common Mode Rejection Common Mode Rejection T_{min} to T_{max}	94 $\pm V_S$ 94			110 $\pm V_S$ 110			110 $\pm V_S$ 100			110 $\pm V_S$ 100			V dB dB
INPUT NOISE Voltage, 0.1Hz to 10Hz $f = 10$ Hz $f = 100$ Hz $f = 1$ kHz Current, $f = 10$ kHz $f = 100$ Hz $f = 1$ kHz	2 35 25 20 0.05 0.03 0.03			2 35 25 20 0.05 0.03 0.03			2 35 25 20 0.05 0.03 0.03			2 35 25 20 0.05 0.03 0.03			μ V p-p nV/ \sqrt{Hz} nV/ \sqrt{Hz} nV/ \sqrt{Hz} pA/ \sqrt{Hz} pA/ \sqrt{Hz} pA/ \sqrt{Hz}
POWER SUPPLY Rated Performance Operating Quiescent Current	± 5 ± 15 ± 18 4			± 5 ± 15 ± 18 3			± 5 ± 15 ± 18 3			± 5 ± 15 ± 18 3			V V mA
TEMPERATURE RANGE Operating, Rated Performance Storage	0 -65 +70 +150			0 -65 +70 +150			0 -65 +70 +150			-55 -65 +125 +150			°C °C
PACKAGE OPTION ¹ TO-99 Style (H-08B) J and S Grade Chips Also Available	AD517JH			AD517KH			AD517LH			AD517SH			

NOTES

¹For outline information see Package Information section.
Specifications subject to change without notice.

Specifications shown in boldface are tested on all production units at final electrical test. Results from those tests are used to calculate outgoing quality levels. All min and max specifications are guaranteed, although only those shown in boldface are tested on all production units.

CHIP DIMENSIONS AND BONDING DIAGRAM

Contact factory for latest dimensions.
Dimensions shown in inches and (mm).

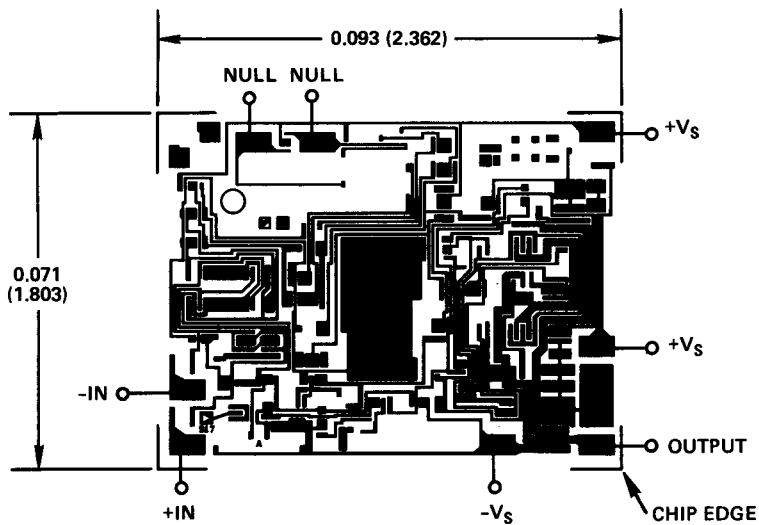

THE AD517 IS AVAILABLE IN
LASER-TRIMMED CHIP FORM.

AD517—Typical Performance Curves

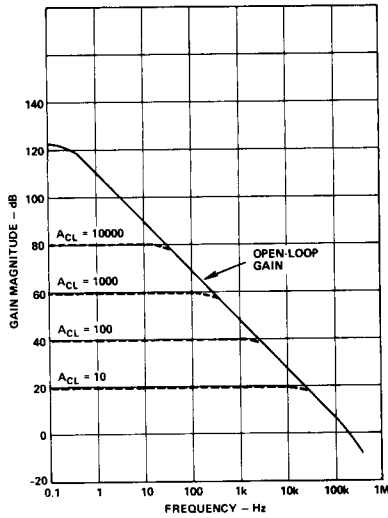

Small-Signal Gain vs. Frequency

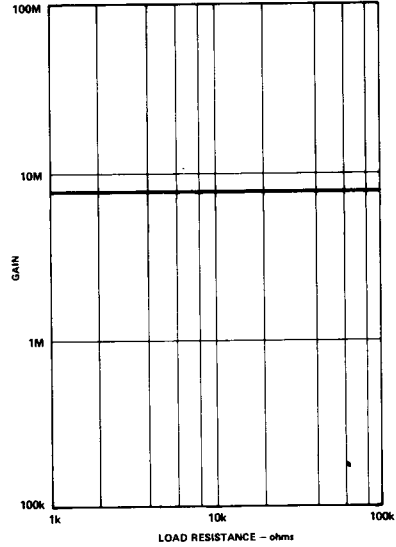

Open-Loop Gain vs. Load Resistance

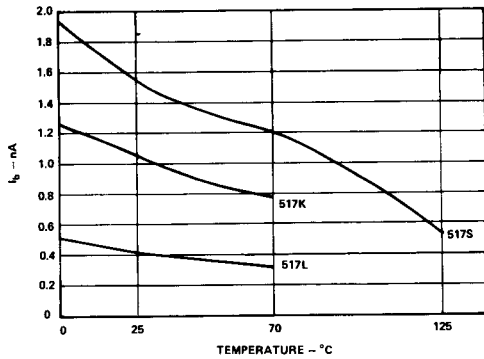

Input Bias Current vs. Temperature

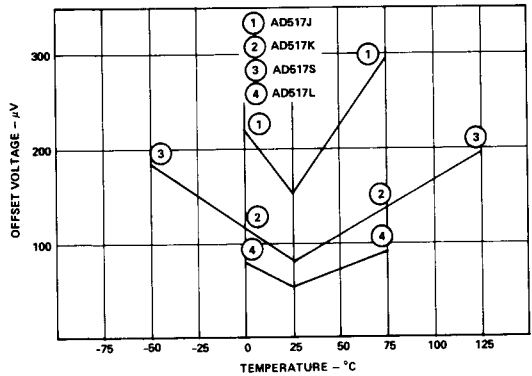

Untrimmed Offset Voltage vs. Temperature

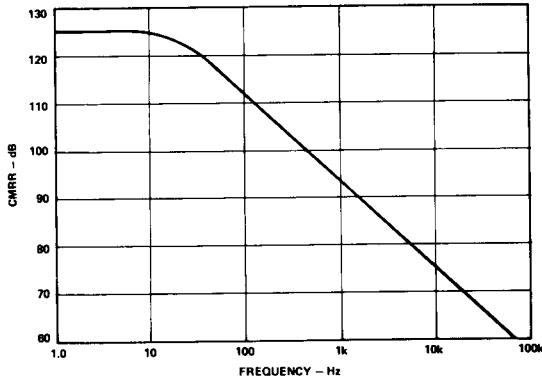

CMRR vs. Frequency

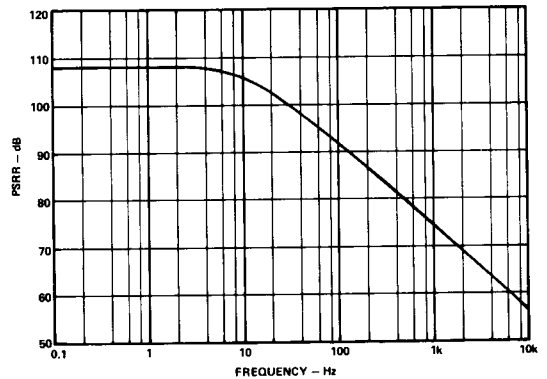

PSRR vs. Frequency

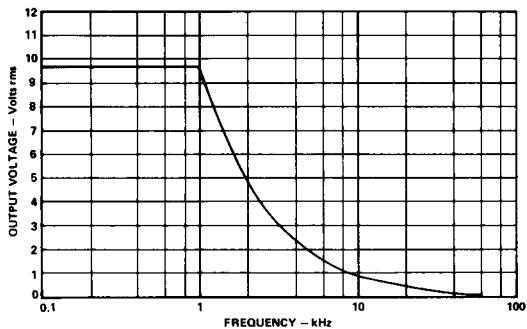

Maximum Undistorted Output vs. Frequency (Distortion $\leq 1\%$)

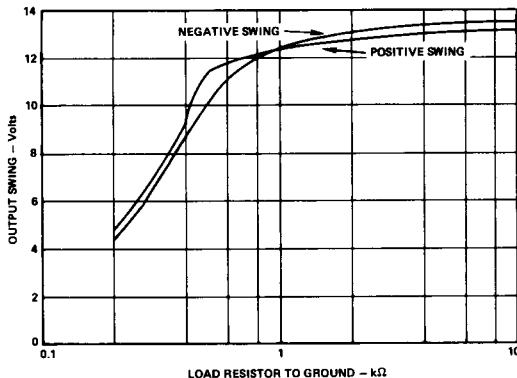

Output Voltage vs. Load Resistance

2

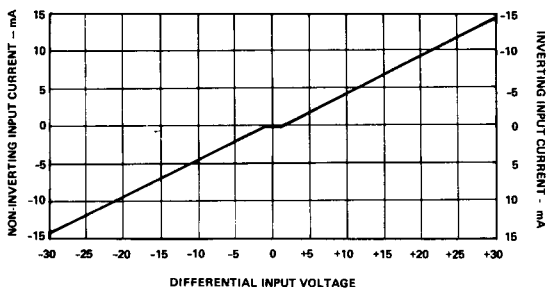

Input Current vs. Differential Input Voltage

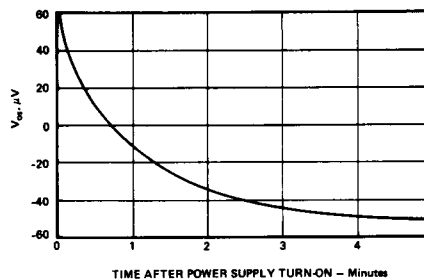

Warm-Up Offset Voltage Drift

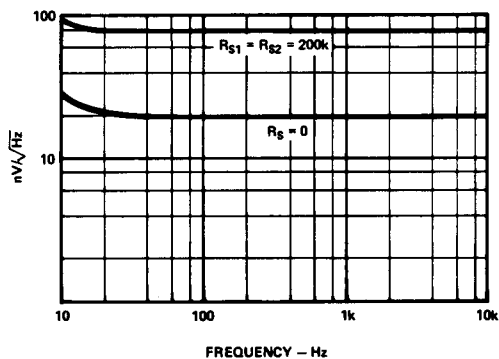

Total Input Noise Voltage vs. Frequency

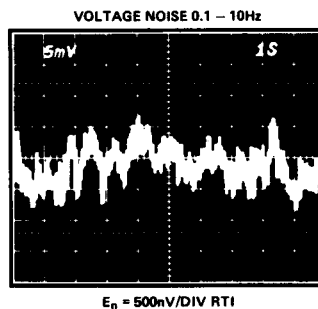

Low Frequency Voltage Noise (0.1 to 10Hz)

AD517—Applications

NULLING THE AD517

The internally-trimmed offset voltage of the AD517 will be low enough for most circuits without further nulling. However, in high precision applications, the AD517 may be nulled using either of the following methods:

Figure 1A shows a simple circuit using a 10kΩ, ten-turn potentiometer. This circuit allows nulling to within several microvolts.

The circuit of Figure 1B is recommended in applications where nulling to within 1μV is desired. This circuit has the advantage that potentiometer instability effects are reduced by a factor of ten. Values of R₁' and R₂' are calculated as follows:

1. Null the offset to zero using a standard 10k pot, as shown in Figure 1A.

2. Measure pot halves R₁ and R₂.

3. Calculate:

$$R_1' = \frac{R_1 \times 50k\Omega}{50k\Omega - R_1} \quad R_2' = \frac{R_2 \times 50k\Omega}{50k\Omega - R_2}$$

4. Replace the pot with R₁' and R₂' using the closest value 1% metal film resistors.

5. Use a 100k, ten-turn pot for R_p to complete the nulling.

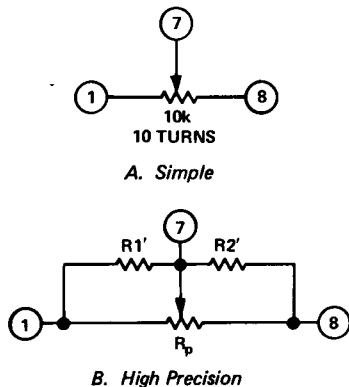

Figure 1. Nulling Circuits

AN INSTRUMENT INPUT AMPLIFIER USING THE AD517L

The circuit shown in Figure 2 represents a typical input stage for laboratory instruments and panel meters. The amplifier is non-inverting and offers selectable gains from 1 to 1000 in decade steps.

Input impedance of this amplifier is 10 megohms, determined by resistor R₁. The offset nulling network comprised of R₃, R₄ and R₅ is the same one described earlier. If a less precise adjustment can be tolerated, a single 10k potentiometer can be substituted for R₃, R₄ and R₅.

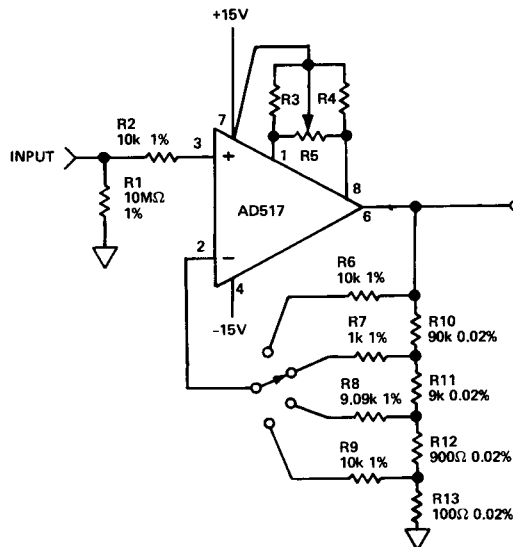

Figure 2. Stable Instrument Input Amplifier

Gain switching is accomplished in the feedback network. The divider consisting of R₁₀, R₁₁, R₁₂ and R₁₃ determines the gain by dividing the output and returning it to the inverting input of the amplifier. The ratio tolerances of these resistors uniquely determine the gain of the amplifier. The impedance seen by the inverting input is held constant at 10k ohms by R₆, R₇, R₈ or R₉ depending on the gain selected. Since input bias currents flow through equal resistances, the offset voltages produced will cancel each other. The input offset currents will produce an insignificant offset voltage on the order of 1 microvolt. If this offset is nulled out at the highest gain selected, it will be nulled on all ranges.

The AD517 offers excellent temperature stability in this circuit. Once the offset has been zeroed, the error produced by offset current drift will remain quite low due to the extremely low offset current drift of the AD517. A FET-input op amp would not work well in this application, since the input offset currents would double for each 10°C increase in temperature, soon exceeding the input offset currents of the AD517.