

FEATURES

Low supply current: 250 μ A/amp maximum
High slew rate: 9 V/ μ s
Bandwidth: 3.5 MHz typical
Low offset voltage: 1 mV maximum @ 25°C
Low input bias current: 20 pA maximum @ 25°C
CMRR: 90 dB typical
Fast settling time
Unity gain stable

APPLICATIONS

Portable telecommunication
Low power industrial and instrumentation
Loop filters
Active and precision filters
Integrators
Strain gauge amplifiers
Portable medical instrumentation
Supply current monitoring

GENERAL DESCRIPTION

The AD8682 and AD8684 are dual and quad low power, precision (1 mV) JFET amplifiers featuring excellent speed at low supply currents. The slew rate is typically 9 V/ μ s with a supply current under 250 μ A per amplifier. These unity-gain stable amplifiers have a typical gain bandwidth of 3.5 MHz. The JFET input stage ensures bias current is typically a few picoamps and below 125 pA maximum over the full temperature operating range.

PIN CONFIGURATIONS

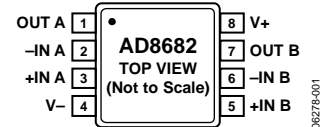

Figure 1. 8-Lead SOIC_N and 8-Lead MSOP

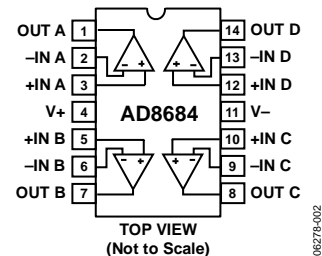

Figure 2. 14-Lead SOIC_N and 14-Lead TSSOP

The devices are ideal for portable, low power applications, especially with high source impedance. The devices are unity gain stable and can drive higher capacity loads ($G = 1$, noninverting), as an example of their excellent dynamic response over a wide range of conditions, delivering dc precision performance at low quiescent currents.

Rev. 0

Information furnished by Analog Devices is believed to be accurate and reliable. However, no responsibility is assumed by Analog Devices for its use, nor for any infringements of patents or other rights of third parties that may result from its use. Specifications subject to change without notice. No license is granted by implication or otherwise under any patent or patent rights of Analog Devices. Trademarks and registered trademarks are the property of their respective owners.

TABLE OF CONTENTS

Features	1	ESD Caution.....	4
Applications.....	1	Typical Performance Characteristic.....	5
Pin Configurations	1	Applications Information	10
General Description	1	High-Side Signal Conditioning	10
Revision History	2	Phase Inversion.....	10
Specifications.....	3	Active Filters	10
Electrical Characteristics	3	Programmable State Variable Filter	11
Absolute Maximum Ratings.....	4	Outline Dimensions	12
Thermal Resistance	4	Ordering Guide	13

REVISION HISTORY

10/06—Revision 0: Initial Version

SPECIFICATIONS

ELECTRICAL CHARACTERISTICS

$V_S = \pm 15.0$ V, $T_A = 25^\circ\text{C}$, $V_{CM} = 0$ V, unless otherwise noted.

Table 1.

Parameter	Symbol	Conditions	Min	Typ	Max	Unit	
INPUT CHARACTERISTICS							
Offset Voltage	V_{OS}	AD8682: $+25^\circ\text{C} \leq T_A \leq +85^\circ\text{C}$ AD8684: $+25^\circ\text{C} \leq T_A \leq +85^\circ\text{C}$ AD8682: $-40^\circ\text{C} \leq T_A \leq +25^\circ\text{C}$ AD8684: $-40^\circ\text{C} \leq T_A \leq +25^\circ\text{C}$		0.35	1	mV	
						2.5	mV
						3.5	mV
						3	mV
						4	mV
Input Bias Current	I_B	$-40^\circ\text{C} \leq T_A \leq +85^\circ\text{C}$		6	20	pA	
Input Offset Current	I_{OS}	$-40^\circ\text{C} \leq T_A \leq +85^\circ\text{C}$			125	pA	
					20	pA	
Input Voltage Range	CMRR	$-11\text{ V} \leq V_{CM} \leq +15\text{ V}$, $-40^\circ\text{C} \leq T_A \leq +85^\circ\text{C}$	-11		+15	V	
			70	90		dB	
Common-Mode Rejection Ratio	A_{VO}	$R_L = 10\text{ k}\Omega$	20			V/mV	
			15			V/mV	
Large Signal Voltage Gain		$R_L = 10\text{ k}\Omega$, $-40^\circ\text{C} \leq T_A \leq +85^\circ\text{C}$				V/mV	
Offset Voltage Drift	$\Delta V_{OS}/\Delta T$			10		$\mu\text{V}/^\circ\text{C}$	
Bias Current Drift	$\Delta I_B/\Delta T$			8		$\text{pA}/^\circ\text{C}$	
OUTPUT CHARACTERISTICS							
Output Voltage High	V_{OH}	$R_L = 10\text{ k}\Omega$	+13.5	+13.9		V	
Output Voltage Low	V_{OL}	$R_L = 10\text{ k}\Omega$		-13.9	-13.5	V	
Short-Circuit Limit	I_{SC}	Source	3	10		mA	
					-12	-8	mA
Open-Loop Output Impedance	Z_{OUT}	$f = 1\text{ MHz}$		200		Ω	
POWER SUPPLY							
Power Supply Rejection Ratio	PSRR	$V_S = \pm 4.5\text{ V to } \pm 18\text{ V}$, $-40^\circ\text{C} \leq T_A \leq +85^\circ\text{C}$	92	114		dB	
Supply Current/Amplifier	I_{SY}	$V_O = 0\text{ V}$, $-40^\circ\text{C} \leq T_A \leq +85^\circ\text{C}$		210	250	μA	
Supply Voltage Range	V_S		± 4.5		± 18	V	
DYNAMIC PERFORMANCE							
Slew Rate	SR	$R_L = 10\text{ k}\Omega$	7	9		$\text{V}/\mu\text{s}$	
Full-Power Bandwidth	BW_P	1% distortion		125		kHz	
Settling Time	t_S	To 0.01%		1.6		μs	
Gain Bandwidth Product	GBP			3.5		MHz	
Phase Margin	ϕ_O			55		Degrees	
NOISE PERFORMANCE							
Voltage Noise	e_n p-p	0.1 Hz to 10 Hz		1.3		$\mu\text{V p-p}$	
Voltage Noise Density	e_n	$f = 1\text{ kHz}$		36		$\text{nV}/\sqrt{\text{Hz}}$	
Current Noise Density	i_n			0.01		$\text{pA}/\sqrt{\text{Hz}}$	

ABSOLUTE MAXIMUM RATINGS

Table 2.

Parameter	Rating
Supply Voltage	±18 V
Input Voltage	±18 V
Differential Input Voltage ¹	36 V
Output Short-Circuit Duration	Indefinite
Storage Temperature Range	−65°C to +150°C
Operating Temperature Range	−40°C to +85°C
Junction Temperature Range	−65°C to +150°C
Lead Temperature (Soldering, 60 sec)	300°C

¹ For supply voltages less than ±18 V, the absolute maximum input voltage is equal to the supply voltage.

Stresses above those listed under Absolute Maximum Ratings may cause permanent damage to the device. This is a stress rating only; functional operation of the device at these or any other conditions above those indicated in the operational section of this specification is not implied. Exposure to absolute maximum rating conditions for extended periods may affect device reliability.

THERMAL RESISTANCE

Table 3.

Package Type	θ_{JA}	θ_{JC}	Unit
8-Lead MSOP [RM-8]	210	45	°C/W
8-Lead SOIC_N [R-8]	158	43	°C/W
14-Lead TSSOP [RU-14]	180	35	°C/W
14-Lead SOIC [R-14]	120	36	°C/W

ESD CAUTION



ESD (electrostatic discharge) sensitive device. Charged devices and circuit boards can discharge without detection. Although this product features patented or proprietary protection circuitry, damage may occur on devices subjected to high energy ESD. Therefore, proper ESD precautions should be taken to avoid performance degradation or loss of functionality.

TYPICAL PERFORMANCE CHARACTERISTIC

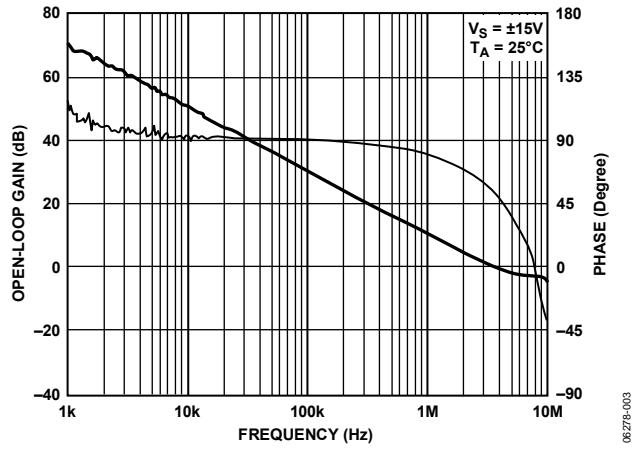

Figure 3. AD8682 Open-Loop Gain and Phase vs. Frequency

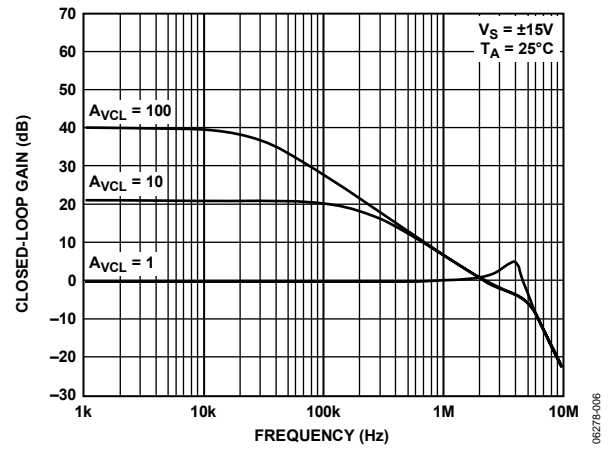

Figure 6. AD8682 Closed-Loop Gain vs. Frequency

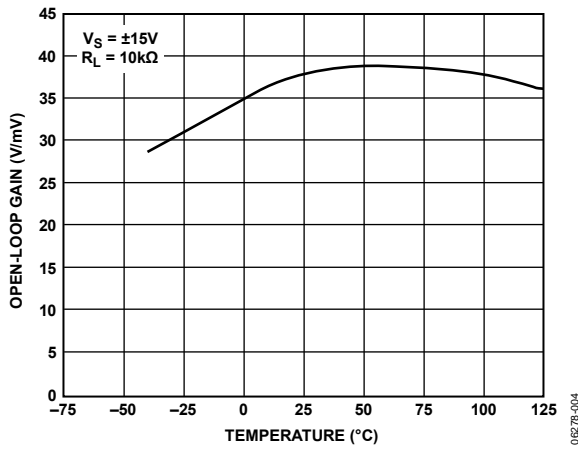

Figure 4. AD8682 Open-Loop Gain vs. Temperature

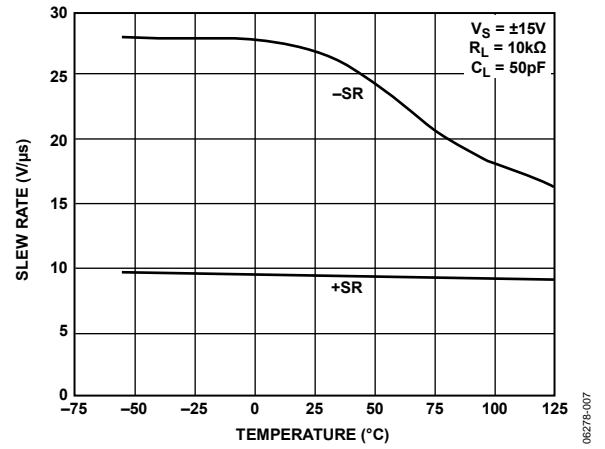

Figure 7. Slew Rate vs. Temperature

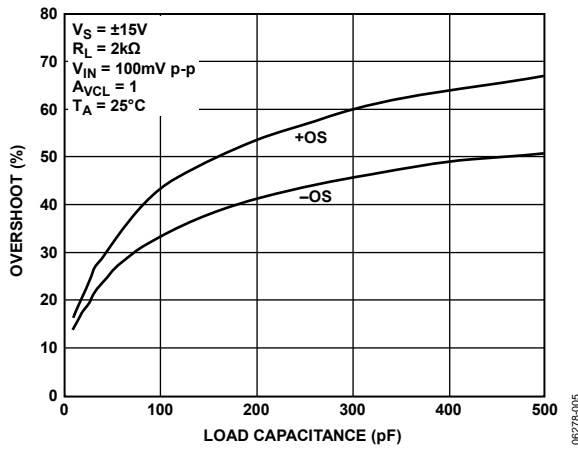

Figure 5. Small Signal Overshoot vs. Load Capacitance

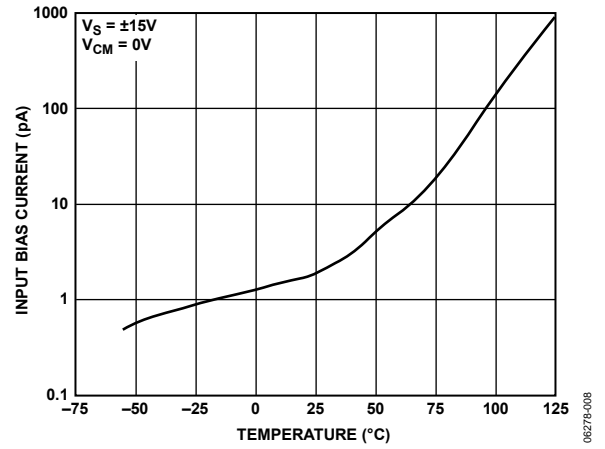

Figure 8. AD8682 Input Bias Current vs. Temperature

AD8682/AD8684

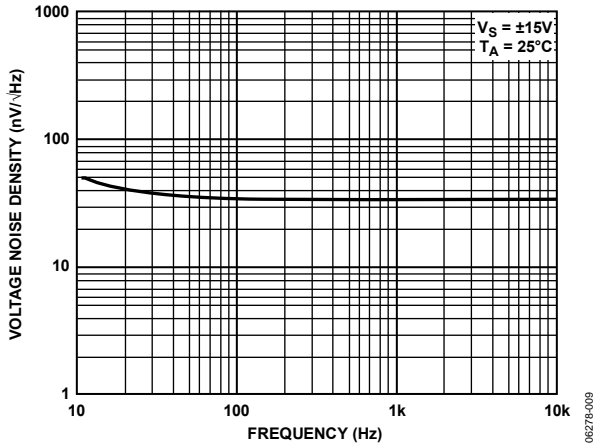

Figure 9. Voltage Noise Density vs. Frequency

06278-009

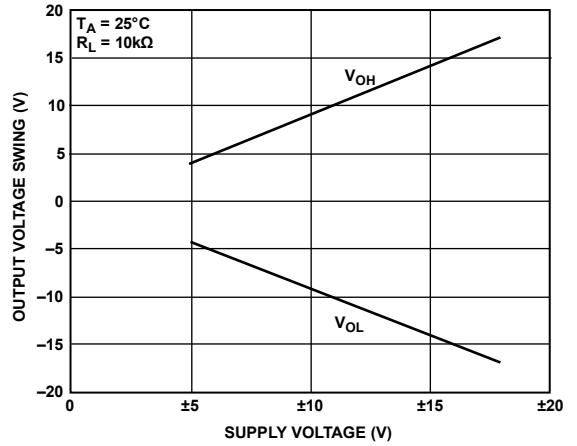

Figure 12. Output Voltage Swing vs. Supply Voltage

06278-012

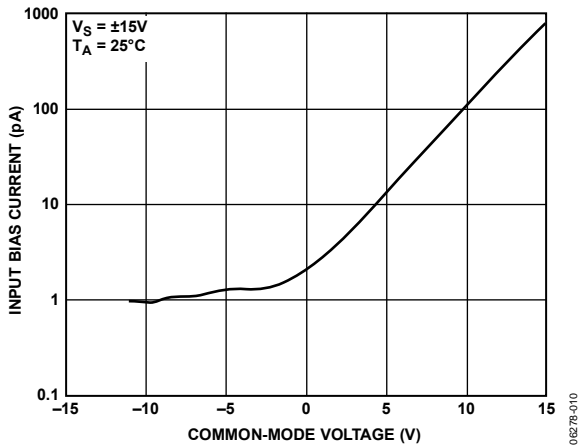

Figure 10. Input Bias Current vs. Common-Mode Voltage

06278-010

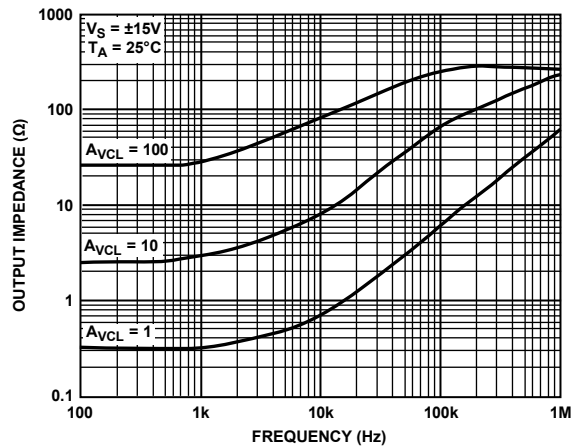

Figure 13. Closed-Loop Output Impedance vs. Frequency

06278-013

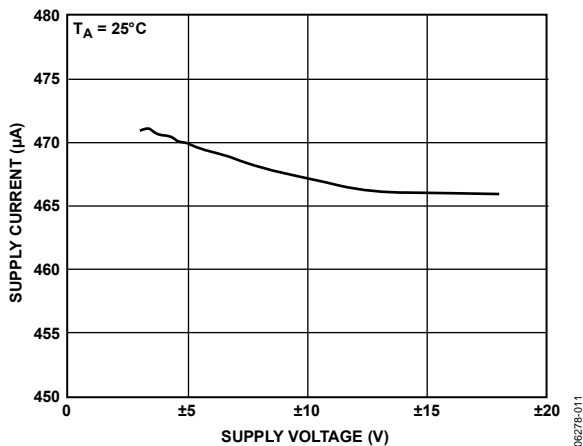

Figure 11. AD8682 Supply Current vs. Supply Voltage

06278-011

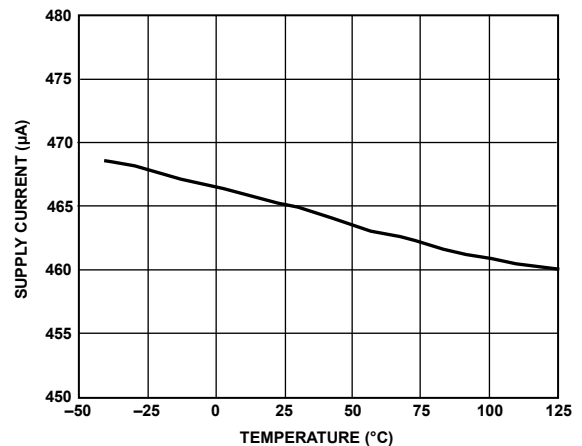

Figure 14. AD8682 Supply Current vs. Temperature

06278-014

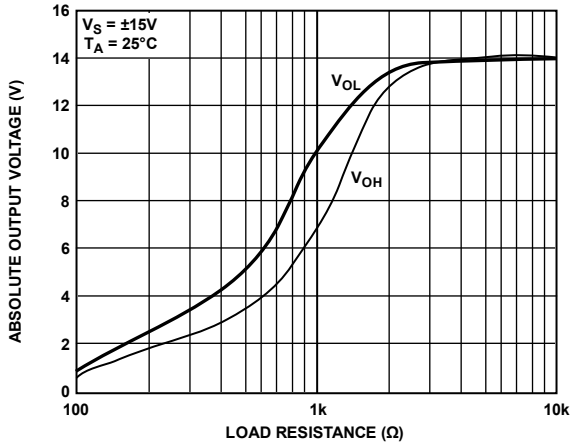

Figure 15. Absolute Output Voltage vs. Load Resistance

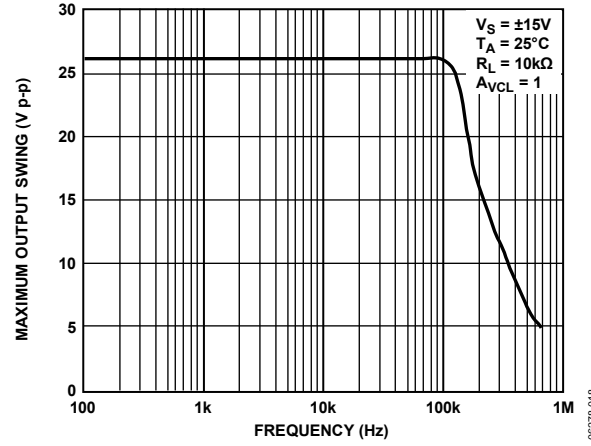

Figure 18. Maximum Output Swing vs. Frequency

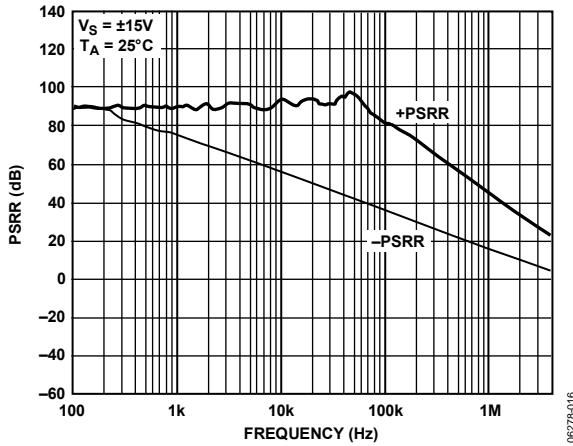

Figure 16. AD8682 PSRR vs. Frequency

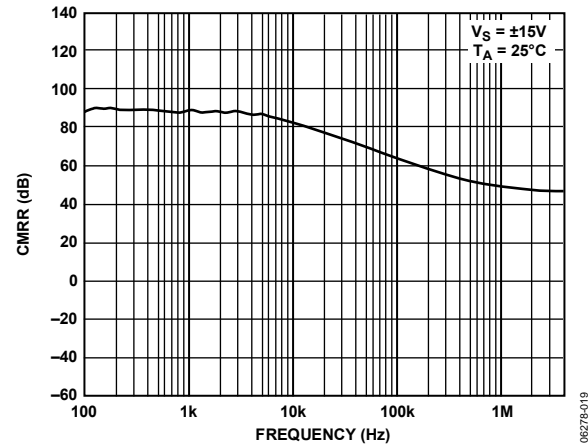

Figure 19. AD8682 CMRR vs. Frequency

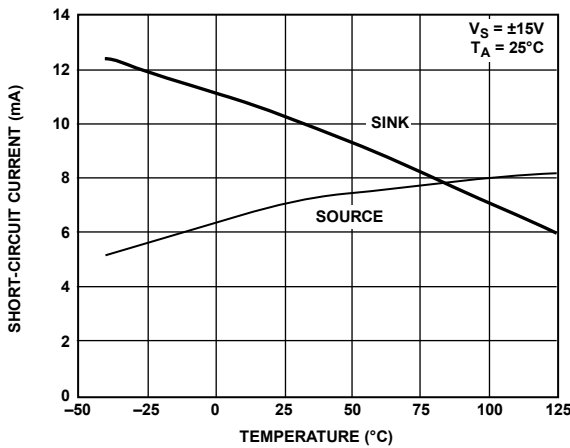

Figure 17. AD8682 Short-Circuit Current vs. Temperature

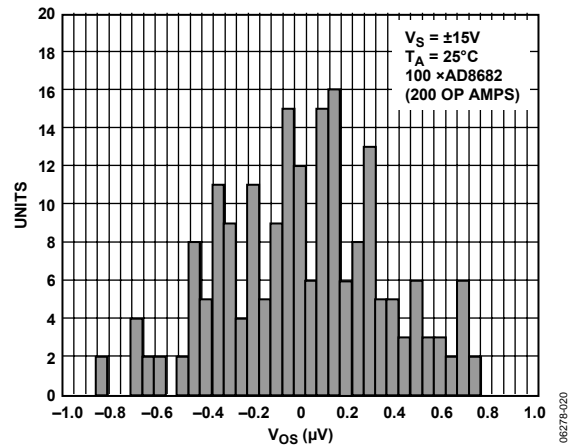

Figure 20. AD8682 V_{OS} Distribution

AD8682/AD8684

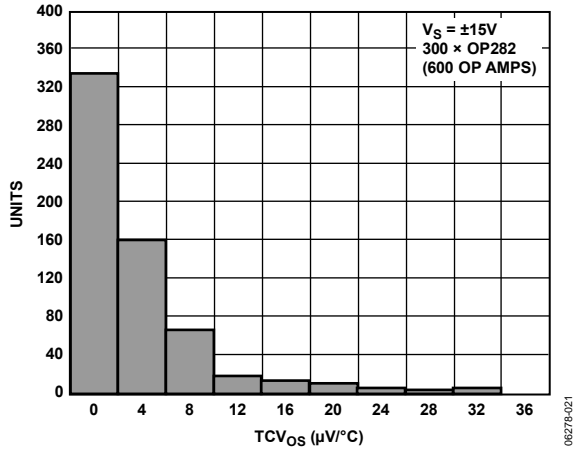

Figure 21. AD8682 TCVos Distribution SOIC_N Package

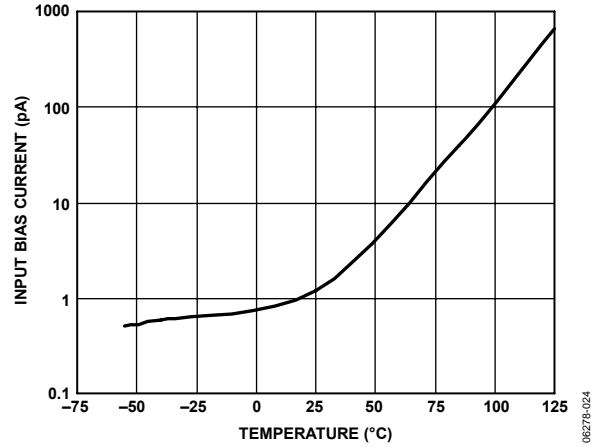

Figure 24. AD8684 Input Bias Current vs. Temperature

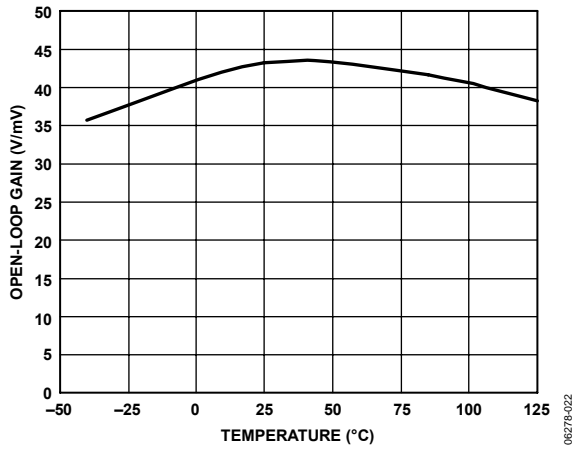

Figure 22. AD8684 Open-Loop Gain vs. Temperature

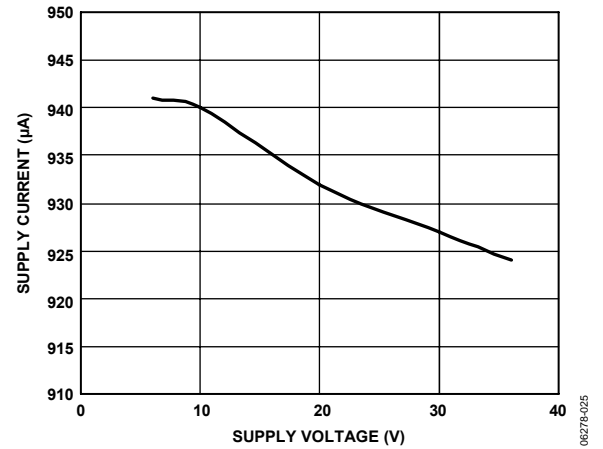

Figure 25. AD8684 Relative Supply Current vs. Supply Voltage

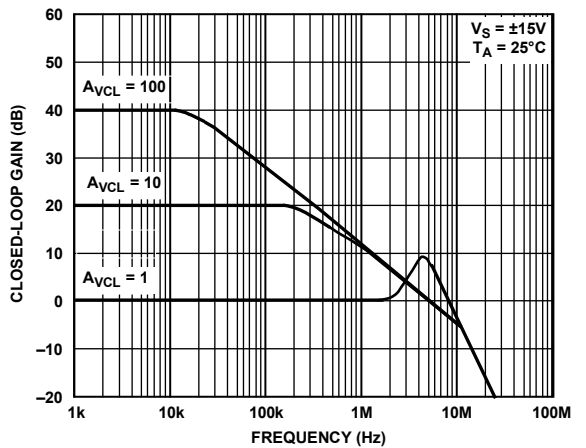

Figure 23. AD8684 Closed-Loop Gain vs. Frequency

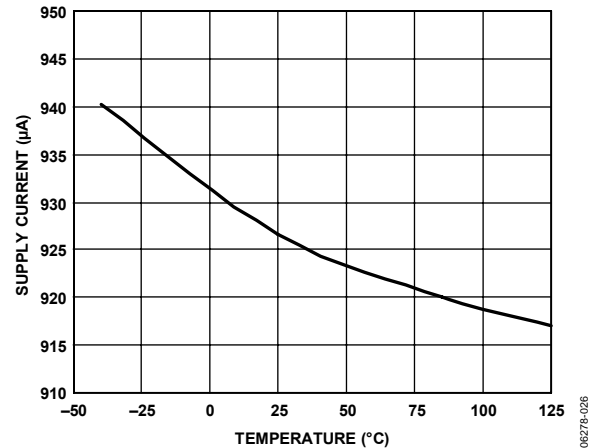

Figure 26. AD8684 Supply Current vs. Temperature

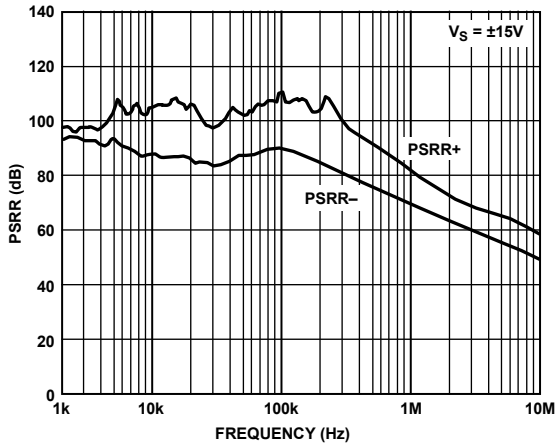

Figure 27. AD8684 PSRR vs. Frequency

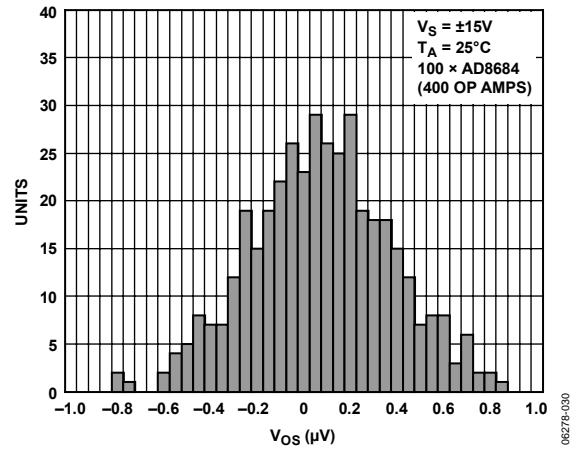

Figure 30. AD8684 V_{OS} Distribution Package

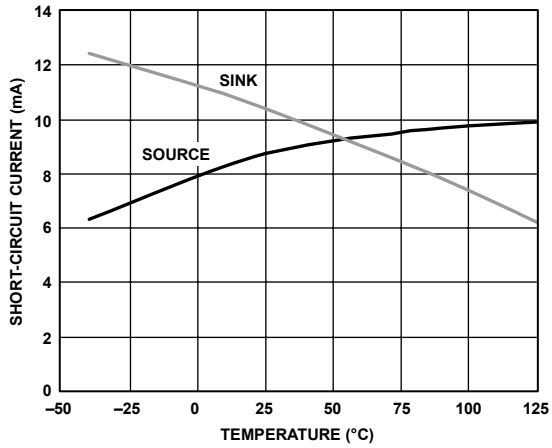

Figure 28. AD8684 Short-Circuit Current vs. Temperature

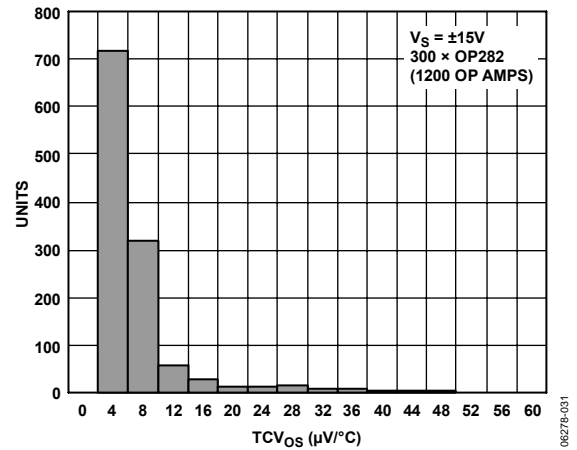

Figure 31. AD8684 TCV_{OS} Distribution Package

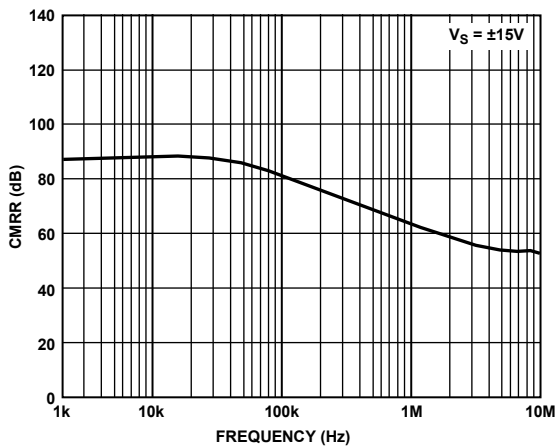

Figure 29. AD8684 CMRR vs. Frequency

APPLICATIONS INFORMATION

The AD8682 and AD8684 are dual and quad JFET op amps that are optimized for high speed at low power. This combination makes these amplifiers excellent choices for battery-powered or low power applications that require above average performance. Applications benefiting from this performance combination include telecommunications, geophysical exploration, portable medical equipment, and navigational instrumentation.

HIGH-SIDE SIGNAL CONDITIONING

There are many applications requiring the sensing of signals near the positive rail. The AD8682 and the AD8684 were tested and are guaranteed over a common-mode range ($-11\text{ V} \leq V_{CM} \leq +15\text{ V}$) that includes the positive supply.

The AD8682/AD8684 are commonly used in the sensing of power supply currents and in current sensing applications, such as the partial circuit shown in Figure 32. In this circuit, the voltage drop across a low value resistor, such as the $0.1\ \Omega$ shown here, is amplified and compared to 7.5 V . The output can then be used for current limiting.

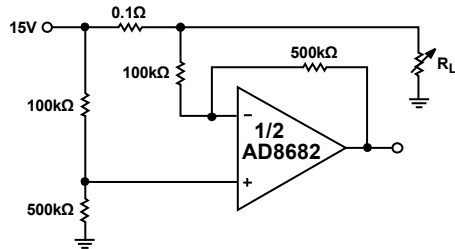

Figure 32. High-Side Signal Conditioning

PHASE INVERSION

Most JFET input amplifiers invert the phase of the input signal if either input exceeds the input common-mode range. For the AD8682/AD8684, negative signals in excess of approximately 14 V cause phase inversion. This is caused by saturation of the input stage leading to the forward-biasing of a drain-gate diode. A simple fix for this in noninverting applications is to place a resistor in series with the noninverting input. This limits the amount of current through the forward-biased diode and prevents shutting down of the output stage. For the AD8682/AD8684, a value of $200\text{ k}\Omega$ has been found to work; however, it adds a significant amount of noise.

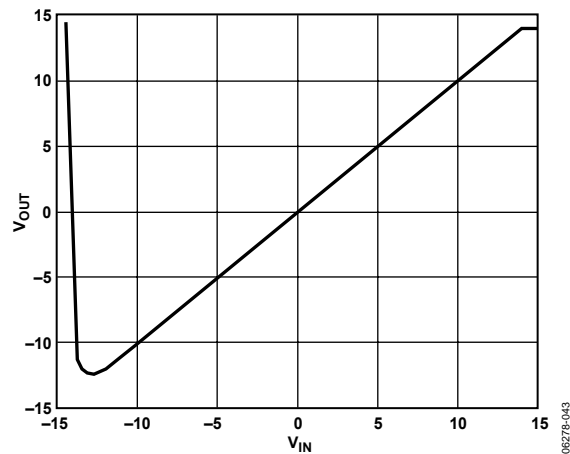

Figure 33. AD8682 Phase Reversal

ACTIVE FILTERS

The wide bandwidth and high slew rates of the AD8682/AD8684 make either one an excellent choice for many filter applications.

There are many active filter configurations, but the four most popular configurations are: Butterworth, elliptical, Bessel, and Chebyshev. Each type has a response that is optimized for a given characteristic, as shown in Table 4.

Table 4.

Type	Selectivity	Overshoot	Phase	Amplitude (Pass Band)	Amplitude (Stop Band)
Butterworth	Moderate	Good	Nonlinear	Maximum flat	Equal ripple
Chebyshev	Good	Moderate		Equal ripple	
Elliptical	Best	Poor	Equal ripple		
Bessel (Thompson)	Poor	Best	Linear		

PROGRAMMABLE STATE VARIABLE FILTER

The circuit shown in Figure 34 can be used to accurately program the Q; the cutoff frequency, f_c ; and the gain of a 2-pole state variable filter. The AD8684 has been used in this design because of its high bandwidth, low power, and low noise. This circuit takes only three packages to build because of the quad configuration of the op amps and DACs.

The DACs shown are used in voltage mode; therefore, many values are dependent on the accuracy of the DAC only and not on the absolute values of the DAC resistive ladders. As a result, this makes the circuit unusually accurate for a programmable filter.

Adjusting DAC 1 changes the signal amplitude across R1; therefore, the DAC attenuation \times R1 determines the amount of signal current that charges the integrating capacitor, C1.

This cutoff frequency can be expressed as

$$f_c = \frac{1}{2\pi R1 C1} \left(\frac{D1}{256} \right)$$

where D1 is the digital code for the DAC.

The gain of this circuit is set by adjusting D3. The gain equation is

$$Gain = \frac{R4}{R5} \left(\frac{D3}{256} \right)$$

DAC 2 is used to set the Q of the circuit. Adjusting this DAC controls the amount of feedback from the band-pass node to the input summing node. Note that the digital value of the DAC is in the numerator; therefore, zero code is not a valid operating point.

$$Q = \frac{R2}{R3} \left(\frac{256}{D2} \right)$$

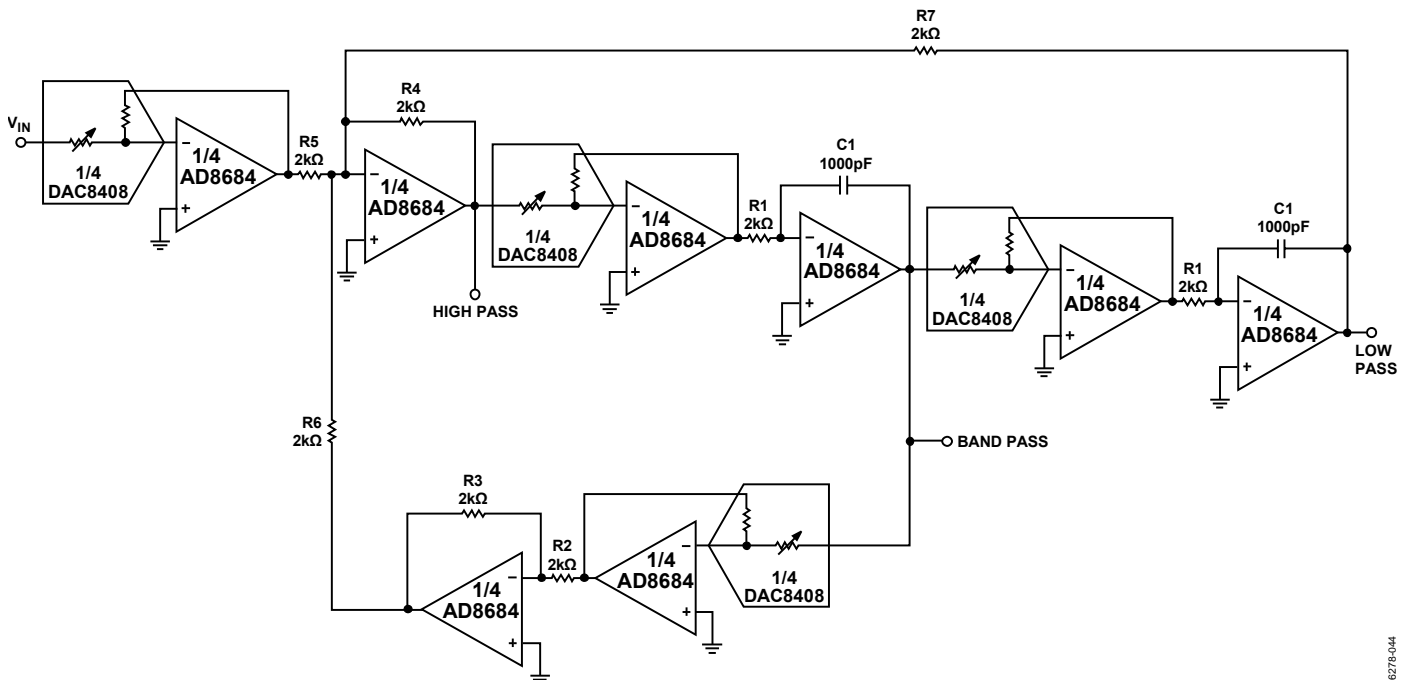
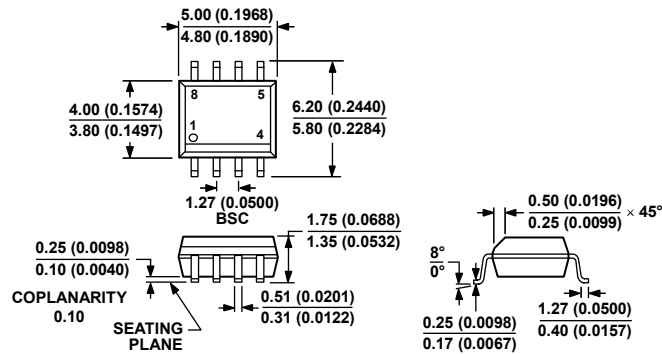

Figure 34. Programmable State Variable Filter

06278-044

OUTLINE DIMENSIONS



COMPLIANT TO JEDEC STANDARDS MS-012-AA
 CONTROLLING DIMENSIONS ARE IN MILLIMETERS; INCH DIMENSIONS
 (IN PARENTHESES) ARE ROUNDED-OFF MILLIMETER EQUIVALENTS FOR
 REFERENCE ONLY AND ARE NOT APPROPRIATE FOR USE IN DESIGN.

060906-A

Figure 35. 8-Lead Standard Small Outline Package [SOIC_N]
 Narrow Body
 (R-8)

Dimensions shown in millimeters and (inches)

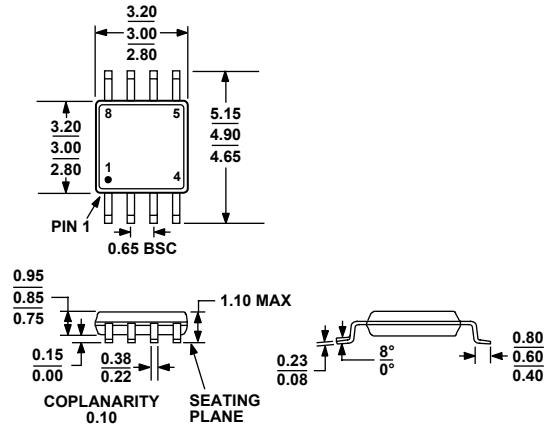

COMPLIANT TO JEDEC STANDARDS MO-187-AA
 Figure 36. 8-Lead Mini Small Outline Package [MSOP]
 (RM-8)

Dimensions shown in millimeters

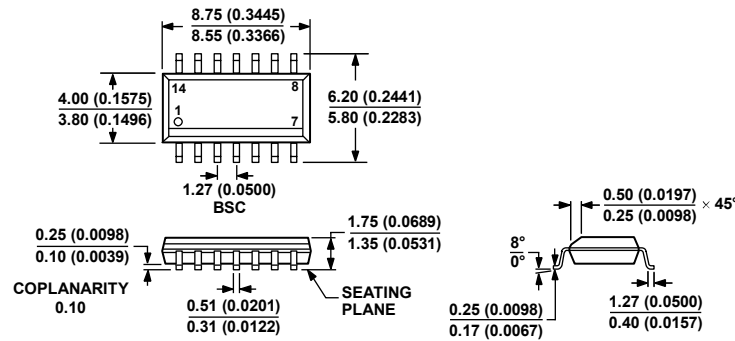

COMPLIANT TO JEDEC STANDARDS MS-012-AB
 CONTROLLING DIMENSIONS ARE IN MILLIMETERS; INCH DIMENSIONS
 (IN PARENTHESES) ARE ROUNDED-OFF MILLIMETER EQUIVALENTS FOR
 REFERENCE ONLY AND ARE NOT APPROPRIATE FOR USE IN DESIGN.

Figure 37. 14-Lead Standard Small Outline Package [SOIC_N]
 Narrow Body
 (R-14)

Dimensions shown in millimeters and (inches)

060606-A

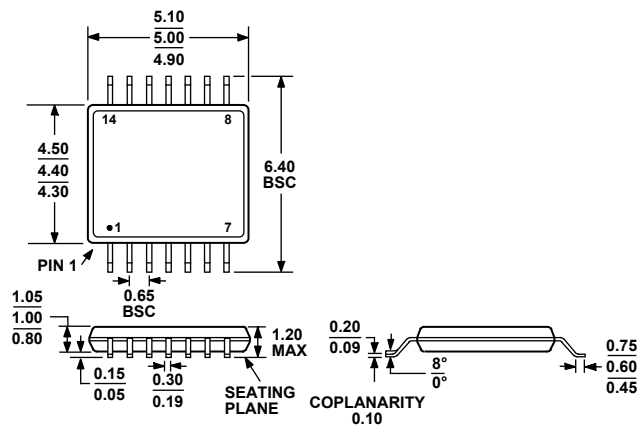

COMPLIANT TO JEDEC STANDARDS MO-153-AB-1

Figure 38. 14-Lead Thin Shrink Small Outline Package [TSSOP]
 (RU-14)

Dimensions shown in millimeters

ORDERING GUIDE

Model	Temperature Range	Package Description	Package Option	Branding
AD8682ARZ ¹	-40°C to +85°C	8-Lead SOIC_N	R-8	
AD8682ARZ-REEL ¹	-40°C to +85°C	8-Lead SOIC_N	R-8	
AD8682ARZ-REEL7 ¹	-40°C to +85°C	8-Lead SOIC_N	R-8	
AD8682ARMZ-R2 ¹	-40°C to +85°C	8-Lead MSOP	RM-8	A1K
AD8682ARMZ-REEL ¹	-40°C to +85°C	8-Lead MSOP	RM-8	A1K
AD8684ARZ ¹	-40°C to +85°C	14-Lead SOIC_N	R-14	
AD8684ARZ-REEL ¹	-40°C to +85°C	14-Lead SOIC_N	R-14	
AD8684ARZ-REEL7 ¹	-40°C to +85°C	14-Lead SOIC_N	R-14	
AD8684ARUZ ¹	-40°C to +85°C	14-Lead TSSOP	RU-14	
AD8684ARUZ_REEL ¹	-40°C to +85°C	14-Lead TSSOP	RU-14	

¹ Z= Pb-free part.

AD8682/AD8684

NOTES

NOTES

AD8682/AD8684

NOTES