



Video Encoder with Six 10-Bit DACs, 54 MHz Oversampling and Progressive Scan Inputs

ADV7192

FEATURES

- Six High-Quality 10-Bit Video DACs
- 10-Bit Internal Digital Video Processing
- Multistandard Video Input
- Multistandard Video Output
- 4× Oversampling with Internal 54 MHz PLL
- Programmable Video Control Includes:
 - Digital Noise Reduction
 - Gamma Correction
 - Black Burst
 - LUMA Delay
 - CHROMA Delay
 - Multiple Luma and Chroma Filters
 - Luma SSAF™ (Super Subalias Filter)
- Average Brightness Detection
- Field Counter
- Macrovision Rev. 7.1
- CGMS (Copy Generation Management System)
- WSS (Wide Screen Signaling)
- Closed Captioning Support.
- Teletext Insertion Port (PAL-WST)
- 2-Wire Serial MPU Interface (I²C®-Compatible and Fast I²C)
- I²C Interface
- Supply Voltage 5 V and 3.3 V Operation
- 80-Lead LQFP Package

APPLICATIONS

- DVD Playback Systems
- PC Video/Multimedia Playback Systems
- Progressive Scan Playback Systems

GENERAL DESCRIPTION

The ADV7192 is part of the new generation of video encoders from Analog Devices. The device builds on the performance of previous video encoders and provides new features like interfacing progressive scan devices, Digital Noise Reduction, Gamma Correction, 4× Oversampling and 54 MHz operation, Average Brightness Detection, Black Burst Signal Generation, Chroma Delay, an additional Chroma Filter, and other features.

The ADV7192 supports NTSC-M, NTSC-N (Japan), PAL N, PAL M, PAL-B/D/G/H/I and PAL-60 standards. Input standards supported include ITU-R.BT656 4:2:2 YCrCb in 8-Bit or 16-Bit format and 3× 10-Bit YCrCb progressive scan format.

The ADV7192 can output Composite Video (CVBS), S-Video (Y/C), Component YUV or RGB and analog progressive scan in YPrPb format. The analog component output is also compatible with Betacam, MII, and SMPTE/EBU N10 levels, SMPTE 170 M NTSC, and ITU-R.BT 470 PAL.

Please see Detailed Description of Features for more information about the ADV7192.

SIMPLIFIED FUNCTIONAL BLOCK DIAGRAM

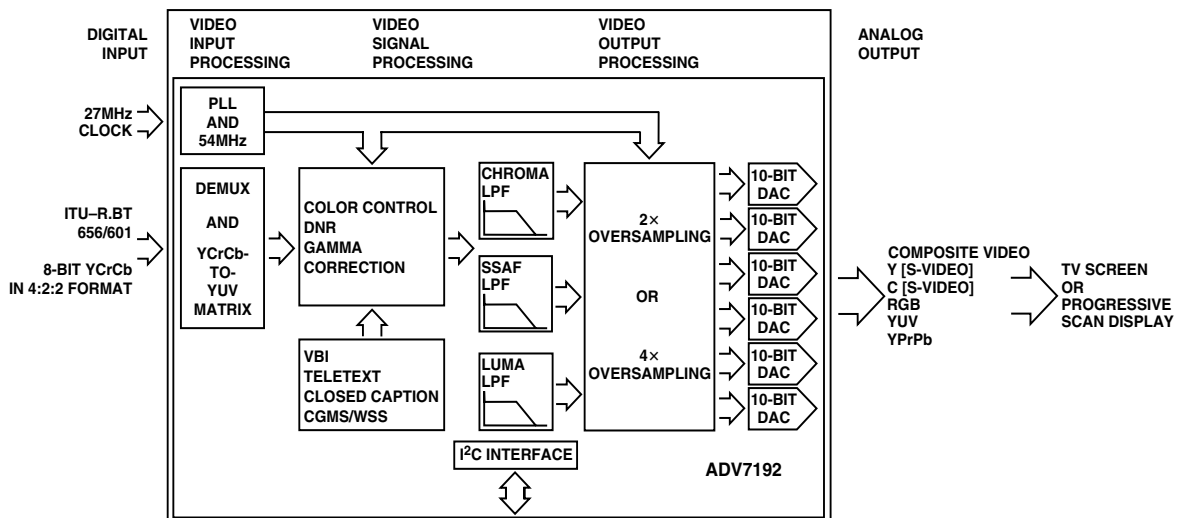

SSAF is a trademark of Analog Devices Inc.
 This device is protected by U.S. patent numbers 4631603, 4577216 and 4819098 and other intellectual property rights.
 ITU-R and CCIR are used interchangeably in this document (ITU-R has replaced CCIR recommendations).
 I²C is a registered trademark of Philips Corporation.
 Throughout the document YUV refers to digital or analog component video.

REV. 0

Information furnished by Analog Devices is believed to be accurate and reliable. However, no responsibility is assumed by Analog Devices for its use, nor for any infringements of patents or other rights of third parties which may result from its use. No license is granted by implication or otherwise under any patent or patent rights of Analog Devices.

ADV7192

CONTENTS

FEATURES	1	MPU PORT DESCRIPTION	28
APPLICATIONS	1	REGISTER ACCESSES	29
GENERAL DESCRIPTION	1	REGISTER PROGRAMMING	29
SIMPLIFIED FUNCTIONAL BLOCK DIAGRAM	1	MODE REGISTERS 0–9	30–35
SPECIFICATIONS		TIMING REGISTERS 0–17	36
Static Performance 5 V	3	SUBCARRIER FREQUENCY AND	
Static Performance 3.3 V	4	PHASE REGISTERS	37
Dynamic Specifications 5 V	5	CLOSED CAPTIONING REGISTERS	37
Dynamic Specifications 3.3 V	5	NTSC PEDESTAL/PAL TELETEXT CONTROL	
Timing Characteristics 5 V	6	REGISTERS	37
Timing Characteristics 3.3 V	7	TELETEXT CONTROL REGISTER	38
ABSOLUTE MAXIMUM RATINGS	9	CGMS_WSS REGISTERS	38
PIN CONFIGURATION	9	CONTRAST CONTROL REGISTERS	39
ORDERING GUIDE	9	HUE ADJUST CONTROL REGISTER (HCR)	40
PACKAGE THERMAL PERFORMANCE	9	HCR BIT DESCRIPTION	40
PIN FUNCTION DESCRIPTIONS	10	BRIGHTNESS CONTROL REGISTER (BCR)	40
DETAILED DESCRIPTION OF FEATURES	11	BCR BIT DESCRIPTION	40
GENERAL DESCRIPTION	11	SHARPNESS RESPONSE REGISTER (PR)	41
DATA PATH DESCRIPTION	12	PR BIT DESCRIPTION	41
INTERNAL FILTER RESPONSE	13	DNR REGISTERS	41
FEATURES: FUNCTIONAL DESCRIPTION	17	DNR BIT DESCRIPTIONS	41
BLACK BURST OUTPUT	17	GAMMA CORRECTION REGISTERS	43
BRIGHTNESS DETECT	17	BRIGHTNESS DETECT REGISTER	44
CHROMA/LUMA DELAY	17	OUTPUT CLOCK REGISTER	44
CLAMP OUTPUT	17	OCR BIT DESCRIPTIONS	44
\overline{CSO} , \overline{HSO} AND \overline{VSO} OUTPUTS	17	APPENDIX 1	
COLOR BAR GENERATION	17	Board Design and Layout Considerations	45
COLOR BURST SIGNAL CONTROL	17	APPENDIX 2	
COLOR CONTROLS	17	Closed Captioning	47
CHROMINANCE CONTROL	17	APPENDIX 3	
UNDERSHOOT LIMITER	18	Copy Generation Management System (CGMS)	48
DIGITAL NOISE REDUCTION	18	APPENDIX 4	
DOUBLE BUFFERING	18	Wide Screen Signaling	49
GAMMA CORRECTION CONTROL	18	APPENDIX 5	
NTSC PEDESTAL CONTROL	18	Teletext Insertion	50
POWER-ON \overline{RESET}	18	APPENDIX 6	
PROGRESSIVE SCAN INPUT	18	Optional Output Filter	51
REAL-TIME CONTROL, SUBCARRIER RESET, AND		APPENDIX 7	
TIMING RESET	19	DAC Buffering	52
SCH PHASE MODE	19	APPENDIX 8	
SLEEP MODE	19	Recommended Register Values	53
SQUARE PIXEL MODE	19	APPENDIX 9	
VERTICAL BLANKING DATA INSERTION		NTSC Waveforms (With Pedestal)	57
AND \overline{BLANK} INPUT	19	NTSC Waveforms (Without Pedestal)	58
YUV LEVELS	20	PAL Waveforms	59
16-BIT INTERFACE	20	Video Measurement Plots	60
4× OVERSAMPLING AND INTERNAL PLL	20	UV Waveforms	64
VIDEO TIMING DESCRIPTION	20	Output Waveforms	65
\overline{RESET} SEQUENCE	20	APPENDIX 10	
		Vector Plots	68
		OUTLINE DIMENSIONS	69

SPECIFICATIONS

5 V SPECIFICATIONS¹ ($V_{AA} = 5\text{ V}$, $V_{REF} = 1.235\text{ V}$, $R_{SET1,2} = 1200\ \Omega$ unless otherwise noted. All specifications T_{MIN} to T_{MAX} ² unless otherwise noted.)

Parameter	Min	Typ	Max	Unit	Test Conditions	
STATIC PERFORMANCE						
Resolution (Each DAC)			10	Bits	Guaranteed Monotonic	
Accuracy (Each DAC)						
Integral Nonlinearity ³			1.0	LSB		
Differential Nonlinearity ³			1.0	LSB		
DIGITAL INPUTS						
Input High Voltage, V_{INH}	2.0			V	$V_{IN} = 0.4\text{ V}$ or 2.4 V	
Input Low Voltage, V_{INL}			0.8	V		
Input Current, I_{IN}		0	± 1	μA		
Input Capacitance, C_{IN}		6	10	pF		
Input Leakage Current ⁴		1		μA		
Input Leakage Current ⁵		200		μA		
DIGITAL OUTPUTS						
Output High Voltage, V_{OH}	2.4			V	$I_{SOURCE} = 400\ \mu\text{A}$ $I_{SINK} = 3.2\text{ mA}$	
Output Low Voltage, V_{OL}		0.8	0.4	V		
Three-State Leakage Current ⁶		10		μA		
Three-State Leakage Current ⁷		200		μA		
Three-State Output Capacitance		6	10	pF		
ANALOG OUTPUTS						
Output Current (Max)	4.125	4.33	4.625	mA	$R_L = 300\ \Omega$ $R_L = 600\ \Omega$ $R_{SET1}, R_{SET2} = 2400\ \Omega$	
Output Current (Min)		2.16		mA		
DAC-to-DAC Matching ³		0.4	2.5	%		
Output Compliance, V_{OC}	0		1.4	V	$I_{OUT} = 0\text{ mA}$	
Output Impedance, R_{OUT}		100		k Ω		
Output Capacitance, C_{OUT}		6		pF		
VOLTAGE REFERENCE						
Reference Range, V_{REF} ⁸	1.112	1.235	1.359	V		
POWER REQUIREMENTS						
V_{AA}	4.75	5.0	5.25	V		
Normal Power Mode						
I_{DAC} (Max) ⁹		29	35	mA		
I_{CCT} (2 \times Oversampling) ^{10, 11}		80	120	mA		
I_{CCT} (4 \times Oversampling) ^{10, 11}		120	170	mA		
I_{PLL}		6	10	mA		
Sleep Mode						
I_{DAC}		0.01		μA		
I_{CCT}		85		μA		

NOTES

¹All measurements are made in 4 \times Oversampling Mode unless otherwise specified.

²Temperature range T_{MIN} to T_{MAX} : 0 $^{\circ}\text{C}$ to 70 $^{\circ}\text{C}$.

³Guaranteed by characterization.

⁴For all inputs but PAL_NTSC and ALSB.

⁵For PAL_NTSC and ALSB inputs.

⁶For all outputs but $\overline{\text{VSO}}$ /TTX/CLAMP.

⁷For $\overline{\text{VSO}}$ /TTX/CLAMP output.

⁸Measurement made in 2 \times Oversampling Mode.

⁹ I_{DAC} is the total current required to supply all DACs including the V_{REF} Circuitry.

¹⁰All six DACs ON.

¹¹ I_{CCT} or the circuit current, is the continuous current required to drive the digital core without I_{PLL} .

Specifications subject to change without notice.

ADV7192—SPECIFICATIONS

3.3 V SPECIFICATIONS¹ ($V_{AA} = 3.3\text{ V}$, $V_{REF} = 1.235\text{ V}$, $R_{SET1,2} = 1200\ \Omega$ unless otherwise noted. All specifications T_{MIN} to T_{MAX} ² unless otherwise noted.)

Parameter	Min	Typ	Max	Unit	Test Conditions
STATIC PERFORMANCE					
Resolution (Each DAC)			10	Bits	
Accuracy (Each DAC)					
Integral Nonlinearity			1.0	LSB	
Differential Nonlinearity			1.0	LSB	Guaranteed Monotonic
DIGITAL INPUTS					
Input High Voltage, V_{INH}		2		V	
Input Low Voltage, V_{INL}		0.8		V	
Input Leakage Current ³		1		μA	
Input Leakage Current ⁴		200		μA	
Input Current, I_{IN}			± 1	μA	$V_{IN} = 0.4\text{ V}$ or 2.4 V
Input Capacitance, C_{IN}		6	10	pF	
DIGITAL OUTPUTS					
Output High Voltage, V_{OH}		2.4		V	$I_{SOURCE} = 400\ \mu\text{A}$
Output Low Voltage, V_{OL}		0.4		V	$I_{SINK} = 3.2\text{ mA}$
Three-State Leakage Current ⁵		10		μA	
Three-State Leakage Current ⁶		200		μA	
Three-State Output Capacitance		6	10	pF	
ANALOG OUTPUTS					
Output Current (Max)	4.125	4.33	4.625	mA	$R_L = 300\ \Omega$
Output Current (Min)		2.16		mA	$R_L = 600\ \Omega$, $R_{SET1,2} = 2400\ \Omega$
DAC-to-DAC Matching		0.4	2.5	%	
Output Compliance, V_{OC}			1.4	V	
Output Impedance, R_{OUT}		100		k Ω	
Output Capacitance, C_{OUT}		6		pF	$I_{OUT} = 0\text{ mA}$
VOLTAGE REFERENCE					
Reference Range, V_{REF} ⁷		1.235		V	$I_{VREFOUT} = 20\ \mu\text{A}$
POWER REQUIREMENTS					
V_{AA}	3.15	3.3	3.6	V	
Normal Power Mode					
I_{DAC} (Max) ⁸		29		mA	
I_{CCT} (2 \times Oversampling) ^{9, 10}		42	54	mA	
I_{CCT} (4 \times Oversampling) ^{9, 10}		68	86	mA	
I_{PLL}		6		mA	
Sleep Mode					
I_{DAC} ¹⁰		0.01		μA	
I_{CCT}		85		μA	

NOTES

¹All measurements are made in 4 \times Oversampling Mode unless otherwise specified and are guaranteed by characterization. In 2 \times Oversampling Mode, power requirement for the ADV7192 is typically 3.0 V.

²Temperature range T_{MIN} to T_{MAX} : 0 $^{\circ}\text{C}$ to 70 $^{\circ}\text{C}$.

³For all inputs but PAL_NTSC and ALSB.

⁴For PAL_NTSC and ALSB inputs.

⁵For all outputs but $\overline{\text{VS0}}$ /TTX/CLAMP.

⁶For $\overline{\text{VS0}}$ /TTX/CLAMP output.

⁷Measurement made in 2 \times Oversampling Mode.

⁸ I_{DAC} is the total current required to supply all DACs including the V_{REF} Circuitry.

⁹All six DACs ON.

¹⁰ I_{CCT} or the circuit current, is the continuous current required to drive the digital core without I_{PLL} .

Specifications subject to change without notice.

5 V DYNAMIC—SPECIFICATIONS¹ ($V_{AA} = 5\text{ V} \pm 250\text{ mV}$, $V_{REF} = 1.235\text{ V}$, $R_{SET1,2} = 1200\ \Omega$ unless otherwise noted. All specifications T_{MIN} to T_{MAX} ² unless otherwise noted.)

Parameter	Min	Typ	Max	Unit	Test Conditions	
Hue Accuracy		0.5		Degrees	Referenced to 40 IRE	
Color Saturation Accuracy		0.7		%		
Chroma Nonlinear Gain		0.7	0.9	±%		
Chroma Nonlinear Phase		0.5		±Degrees		
Chroma/Luma Intermod		0.1		±%		
Chroma/Luma Gain Ineq		1.7		±%		
Chroma/Luma Delay Ineq		2.2		ns		
Luminance Nonlinearity		0.6	0.7	±%		
Chroma AM Noise		82		dB		
Chroma PM Noise		72		dB		
Differential Gain ³		0.1 (0.4)	0.3 (0.5)	%		
Differential Phase ³		0.4 (0.15)	0.5 (0.3)	Degrees		
SNR (Pedestal) ³		78.5 (78)		dB rms		RMS
		78 (78)		dB p-p		Peak Periodic
SNR (Ramp) ³		61.7 (61.7)		dB rms	RMS	
		62 (63)		dB p-p	Peak Periodic	

NOTES

¹All measurements are made in 4× Oversampling Mode unless otherwise specified and are guaranteed by characterization.

²Temperature range T_{MIN} to T_{MAX} : 0°C to 70°C.

³Values in parentheses apply to 2× Oversampling Mode.

Specifications subject to change without notice.

3.3 V DYNAMIC—SPECIFICATIONS¹ ($V_{AA} = 3.3\text{ V} \pm 150\text{ mV}$, $V_{REF} = 1.235\text{ V}$, $R_{SET1,2} = 1200\ \Omega$ unless otherwise noted. All specifications T_{MIN} to T_{MAX} ² unless otherwise noted.)

Parameter	Min	Typ	Max	Unit	Test Conditions	
Hue Accuracy		0.5		Degrees	Referenced to 40 IRE	
Color Saturation Accuracy		0.8		%		
Luminance Nonlinearity		0.6		±%		
Chroma AM Noise		83		dB		
Chroma PM Noise		71		dB		
Chroma Nonlinear Gain		0.7		±%		
Chroma Nonlinear Phase		0.5		±Degrees		
Chroma/Luma Intermod		0.1		±%		
Differential Gain ³		0.2 (0.5)		%		
Differential Phase ³		0.5 (0.2)		Degrees		
SNR (Pedestal) ³		78.5 (78)		dB rms		RMS
		78 (78)		dB p-p		Peak Periodic
SNR (Ramp) ³		62.3 (62)		dB rms		RMS
		61 (62.5)		dB p-p		Peak Periodic

NOTES

¹All measurements are made in 4× Oversampling Mode unless otherwise specified and are guaranteed by characterization.

²Temperature range T_{MIN} to T_{MAX} : 0°C to 70°C.

³Values in parentheses apply to 2× Oversampling Mode.

Specifications subject to change without notice.

ADV7192

5 V TIMING CHARACTERISTICS

($V_{AA} = 5\text{ V} \pm 250\text{ mV}$, $V_{REF} = 1.235\text{ V}$, $R_{SET1,2} = 1200\text{ }\Omega$ unless otherwise noted. All specifications T_{MIN} to T_{MAX} ¹ unless otherwise noted.)

Parameter	Min	Typ	Max	Unit	Test Conditions
MPU PORT²					
SCLOCK Frequency	0		400	kHz	After This Period the First Clock Is Generated Relevant for Repeated Start Condition
SCLOCK High Pulsewidth, t_1	0.6			μs	
SCLOCK Low Pulsewidth, t_2	1.3			μs	
Hold Time (Start Condition), t_3	0.6			μs	
Setup Time (Start Condition), t_4	0.6			μs	
Data Setup Time, t_5	100			ns	
SDATA, SCLOCK Rise Time, t_6			300	ns	
SDATA, SCLOCK Fall Time, t_7			300	ns	
Setup Time (Stop Condition), t_8	0.6			μs	
ANALOG OUTPUTS²					
Analog Output Delay		8		ns	
DAC Analog Output Skew		0.1		ns	
CLOCK CONTROL AND PIXEL PORT³					
f_{CLOCK}		27		MHz	
Clock High Time, t_9	8	2		ns	
Clock Low Time, t_{10}	8	3		ns	
Data Setup Time, t_{11}	6	2.5		ns	
Data Hold Time, t_{12}	5	2.0		ns	
Control Setup Time, t_{11}	6			ns	
Control Hold Time, t_{12}	4			ns	
Digital Output Access Time, t_{13}		13		ns	
Digital Output Hold Time, t_{14}		12		ns	
Pipeline Delay, t_{15} (2× Oversampling)		57		Clock Cycles	
Pipeline Delay, t_{15} (4× Oversampling)		67		Clock Cycles	
TELETEXT PORT⁴					
Digital Output Access Time, t_{16}		11		ns	
Data Setup Time, t_{17}		3		ns	
Data Hold Time, t_{18}		6		ns	
RESET CONTROL					
RESET Low Time		3	20	ns	
PLL²					
PLL Output Frequency		54		MHz	

NOTES

¹Temperature range T_{MIN} to T_{MAX} : 0°C to 70°C.

²Guaranteed by characterization.

³Pixel Port consists of:

Data: P7-P0, Y0/P8-Y7/P15 Pixel Inputs

Control: HSYNC, VSYNC, BLANK

Clock: CLKIN

⁴Teletext Port consists of:

Digital Output: TTXRQ

Data: TTX

Specifications subject to change without notice.

3.3 V TIMING CHARACTERISTICS ($V_{AA} = 3.3 \text{ V} \pm 150 \text{ mV}$, $V_{REF} = 1.235 \text{ V}$, $R_{SET1,2} = 1200 \Omega$ unless otherwise noted. All specifications T_{MIN} to T_{MAX} ¹ unless otherwise noted.)²

Parameter	Min	Typ	Max	Unit	Test Conditions
MPU PORT					
SCLOCK Frequency	0		400	kHz	After This Period the First Clock Is Generated Relevant for Repeated Start Condition
SCLOCK High Pulsewidth, t_1	0.6			μs	
SCLOCK Low Pulsewidth, t_2	1.3			μs	
Hold Time (Start Condition), t_3	0.6			μs	
Setup Time (Start Condition), t_4	0.6			μs	
Data Setup Time, t_5	100			ns	
SDATA, SCLOCK Rise Time, t_6			300	ns	
SDATA, SCLOCK Fall Time, t_7			300	ns	
Setup Time (Stop Condition), t_8	0.6	2		μs	
ANALOG OUTPUTS					
Analog Output Delay		8		ns	
DAC Analog Output Skew		0.1		ns	
CLOCK CONTROL AND PIXEL PORT³					
f_{CLOCK}		27		MHz	
Clock High Time, t_9	8	2		ns	
Clock Low Time, t_{10}	8	3		ns	
Data Setup Time, t_{11}	6	4		ns	
Data Hold Time, t_{12}	4	2.0		ns	
Control Setup Time, t_{11}	2, 5			ns	
Control Hold Time, t_{12}	3			ns	
Digital Output Access Time, t_{13}		13		ns	
Digital Output Hold Time, t_{14}		12		ns	
Pipeline Delay, t_{15} (2× Oversampling)		37		Clock Cycles	
TELETEXT PORT⁴					
Digital Output Access Time, t_{16}		11		ns	
Data Setup Time, t_{17}		3		ns	
Data Hold Time, t_{18}		6		ns	
$\overline{\text{RESET}}$ CONTROL					
$\overline{\text{RESET}}$ Low Time		3	20	ns	
PLL					
PLL Output Frequency		54		MHz	

NOTES¹Temperature range T_{MIN} to T_{MAX} : 0°C to 70°C.²Guaranteed by characterization.³Pixel Port consists of:

Data: P7–P0, Y0/P8–Y7/P15 Pixel Inputs

Control: $\overline{\text{HSYNC}}$, $\overline{\text{VSYNC}}$, $\overline{\text{BLANK}}$

Clock: CLKIN

⁴Teletext Port consists of:

Digital Output: TTXRQ

Data: TTX

Specifications subject to change without notice.

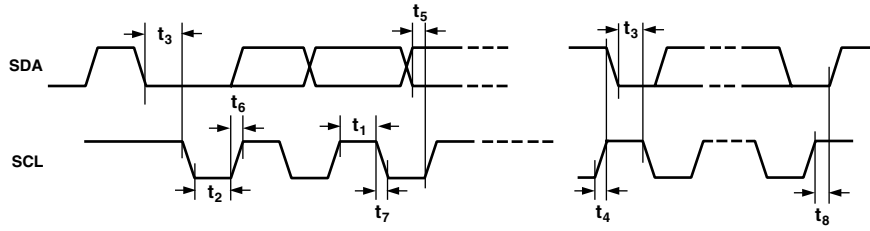

Figure 1. MPU Port Timing Diagram

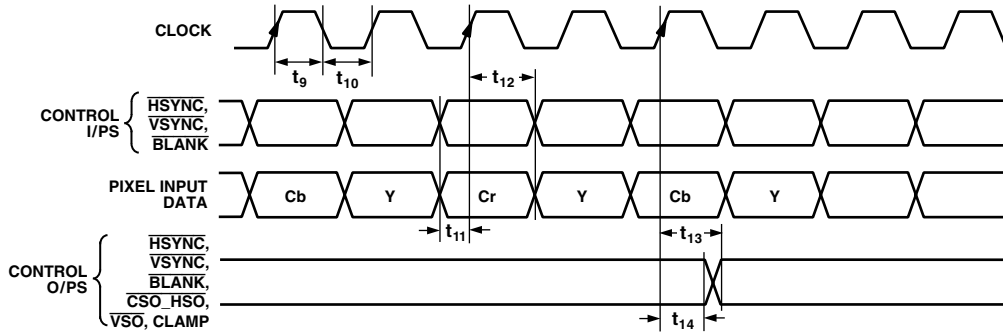

Figure 2. Pixel and Control Data Timing Diagram

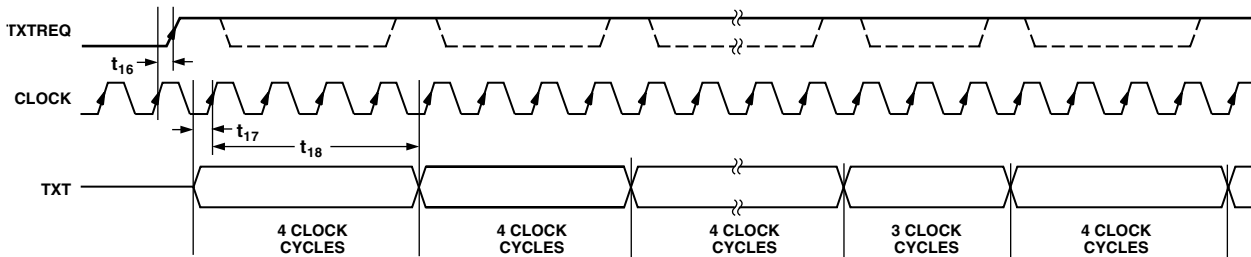

Figure 3. Teletext Timing Diagram

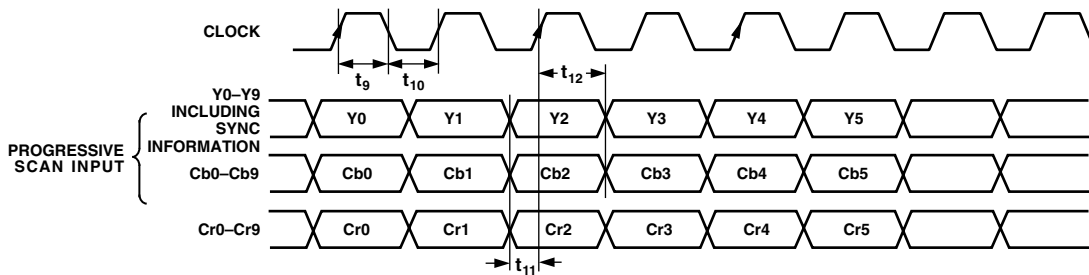

Figure 4. Progressive Scan Input Timing

ABSOLUTE MAXIMUM RATINGS¹

V _{AA} to GND	7 V
Voltage on any Digital Input Pin	GND – 0.5 V to V _{AA} + 0.5 V
Storage Temperature (T _S)	–65°C to +150°C
Junction Temperature (T _J)	150°C
Body Temperature (Soldering, 10 secs)	220°C
Analog Outputs to GND ²	GND – 0.5 V to V _{AA}

NOTES

¹Stresses above those listed under Absolute Maximum Ratings may cause permanent damage to the device. This is a stress rating only; functional operation of the device at these or any other conditions above those listed in the operational sections of this specification is not implied. Exposure to absolute maximum rating conditions for extended periods may affect device reliability.

²Analog Output Short Circuit to any Power Supply or Common can be of an indefinite duration.

PACKAGE THERMAL PERFORMANCE

The 80-lead package is used for this device. The junction-to-ambient (θ_{JA}) thermal resistance in still air on a four-layer PCB is 24.7°C.

To reduce power consumption when using this part the user can run the part on a 3.3 V supply, turn off any unused DACs.

The user must at all times stay below the maximum junction temperature of 110°C. The following equation shows how to calculate this junction temperature:

$$\text{Junction Temperature} = (V_{AA} \times (I_{DAC} + I_{CCT})) \times \theta_{JA} + 70^\circ\text{C } T_{AMB}$$

$$I_{DAC} = 10 \text{ mA} + (\text{sum of the average currents consumed by each powered-on DAC})$$

$$\text{Average current consumed by each powered-on DAC} =$$

$$(V_{REF} \times K) / R_{SET}$$

$$V_{REF} = 1.235 \text{ V}$$

$$K = 4.2146$$

PIN CONFIGURATION

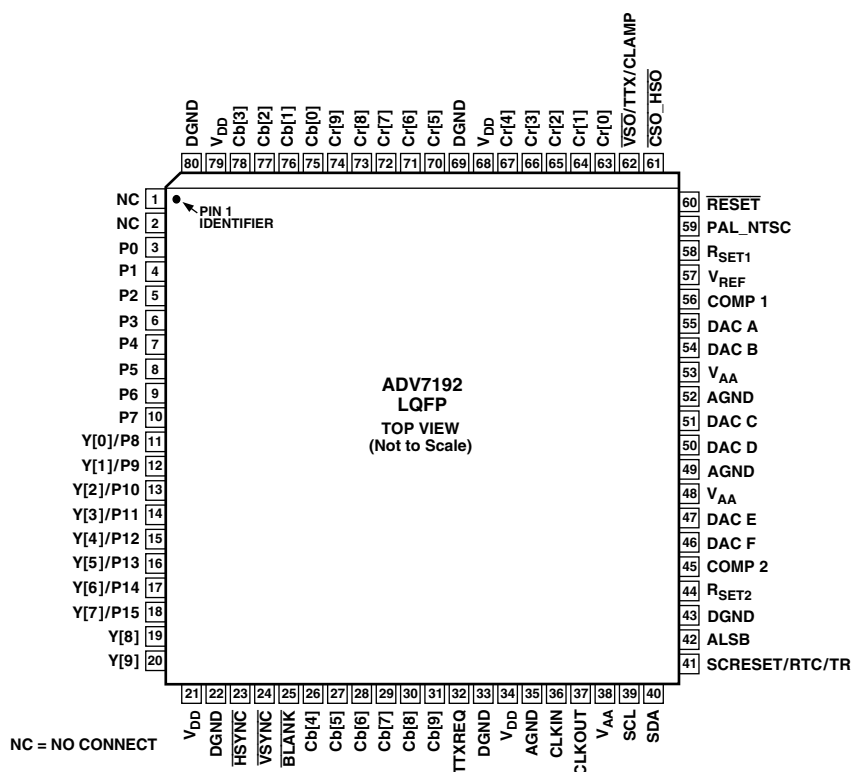

ORDERING GUIDE

Model	Temperature Range	Package Description	Package Option
ADV7192KST	0°C to 70°C	80-Lead Quad Flatpack	ST-80

CAUTION

ESD (electrostatic discharge) sensitive device. Electrostatic charges as high as 4000 V readily accumulate on the human body and test equipment and can discharge without detection. Although the ADV7192 features proprietary ESD protection circuitry, permanent damage may occur on devices subjected to high-energy electrostatic discharges. Therefore, proper ESD precautions are recommended to avoid performance degradation or loss of functionality.



PIN FUNCTION DESCRIPTIONS

Pin No.	Mnemonic	Input/Output	Function
1, 2 3–10	NC P0–P7	I	No Connect. 8-Bit 4:2:2 Multiplexed YCrCb Pixel Port. The LSB of the input data is set up on Pin P0 (Pin Number 3).
11–18	Y0/P8–Y7/P15	I	16-Bit 4:2:2 Multiplexed YCrCb Pixel Port (Bits 8–15). 1 × 10-bit progressive scan input for Ydata (Bits 0–7).
19, 20	Y8–Y9	I	1 × 10-bit progressive scan input is Ydata (Bits 8 and 9).
21, 34, 68, 79	V _{DD}	P	Digital Power Supply (3.3 V to 5 V).
22, 33, 43, 69, 80	DGND	G	Digital Ground.
23	$\overline{\text{HSYNC}}$	I/O	$\overline{\text{HSYNC}}$ (Modes 1, 2, and 3) Control Signal. This pin may be configured to be an output (Master Mode) or an input (Slave Mode) and accept Sync Signals.
24	$\overline{\text{VSYNC}}$	I/O	$\overline{\text{VSYNC}}$ Control Signal. This pin may be configured as an output (Master Mode) or as an input (Slave Mode) and accept $\overline{\text{VSYNC}}$ as a Control Signal.
25	$\overline{\text{BLANK}}$	I/O	Video Blanking Control Signal. This signal is optional. For further information see Vertical Blanking and Data Insertion Blanking Input section.
26–31, 75–78	Cb4–Cb9, Cb0–Cb3	I	1 × 10-Bit Progressive Scan Input Port for Cb data.
32	TTXREQ	O	Teletext Data Request Output Signal, used to control teletext data transfer.
35, 49, 52	AGND	G	Analog Ground.
36	CLKIN	I	TTL Clock Input. Requires a stable 27 MHz reference clock for standard operation. Alternatively, a 24.5454 MHz (NTSC) or 29.5 MHz (PAL) can be used for square pixel operation.
37	CLKOUT	O	Clock Output pin.
38, 48, 53	V _{AA}	P	Analog Power Supply (3.3 V to 5 V).
39	SCL	I	MPU Port Serial Interface Clock Input.
40	SDA	I/O	MPU Port Serial Data Input/Output.
41	SCRESET/ RTC/TR	I	Multifunctional Input: Real Time Control (RTC) input, Timing Reset input, Subcarrier Reset input.
42	ALSB	I	TTL Address Input. This signal sets up the LSB of the MPU address.
44	R _{SET2}	I	A 1200 Ω resistor connected from this pin to GND is used to control full-scale amplitudes of the Video Signals from the DAC D, E, F.
45	COMP 2	O	Compensation Pin for DACs D, E, and F. Connect a 0.1 μF Capacitor from COMP2 to V _{AA} .
46	DAC F	O	S-Video C/Pr/V/RED Analog Output. This DAC is capable of providing 4.33 mA output.
47	DAC E	O	S-Video Y/Pb/U/BLUE Analog Output. This DAC is capable of providing 4.33 mA output.
50	DAC D	O	Composite/Y (progressive scan)/Y/Green Analog Output. This DAC is capable of providing 4.33 mA output.
51	DAC C	O	S-Video C/Pr/V/RED Analog Output. This DAC is capable of providing 4.33 mA output.
54	DAC B	O	S-Video Y/Pb/U/BLUE Analog Output. This DAC is capable of providing 4.33 mA output.
55	DAC A	O	Composite/Y(progressive scan)/Y/Green Analog Output. This DAC is capable of providing 4.33 mA output.
56	COMP 1	O	Compensation Pin for DACs A, B, and C. Connect a 0.1 μF Capacitor from COMP1 to V _{AA} .
57	V _{REF}	I/O	Voltage Reference Input for DACs or Voltage Reference Output (1.235 V). An external V _{REF} cannot be used in 4× Oversampling Mode.
58	R _{SET1}	I	A 1200 Ω resistor connected from this pin to GND is used to control full-scale amplitudes of the Video Signals from the DAC A, B, C.
59	PAL_NTSC	I	Input signal to select PAL or NTSC mode of operation, pin set to Logic 1 selects PAL.
60	$\overline{\text{RESET}}$	I	The input resets the on-chip timing generator and sets the ADV7192 into default mode. See Appendix 8 for Default Register settings.
61	$\overline{\text{CSO_HSO}}$	O	Dual function $\overline{\text{CSO}}$ or $\overline{\text{HSO}}$ Output Sync Signal at TTL Level.
62	$\overline{\text{VSO/TTX/CLAMP}}$	I/O	Multifunctional Pin. $\overline{\text{VSO}}$ Output Sync Signal at TTL level. Teletext Data Input pin. CLAMP TTL output signals can be used to drive external circuitry to enable clamping of all video signals.
63–67, 70–74	Cr0–Cr4, Cr5–Cr9	I	1 × 10-Bit progressive scan input port for Cr data.

DETAILED DESCRIPTION OF FEATURES

Clocking:

Single 27 MHz Clock Required to Run the Device

4x Oversampling with Internal 54 MHz PLL

Square Pixel Operation

Advanced Power Management

Programmable Video Control Features:

Digital Noise Reduction

Black Burst Signal Generation

Pedestal Level

Hue, Brightness, Contrast, and Saturation

Clamping Output Signal

VBI (Vertical Blanking Interval)

Subcarrier Frequency and Phase

LUMA Delay

CHROMA Delay

Gamma Correction

Luma And Chroma Filters

Luma SSAF (Super Subalias Filter)

Average Brightness Detection

Field Counter

Interlaced/Noninterlaced Operation

Complete On-Chip Video Timing Generator

Programmable Multimode Master/Slave Operation

Macrovision Rev 7.1

CGMS (Copy Generation Management System)

WSS (Wide Screen Signaling)

Closed Captioning Support

Teletext Insertion Port (PAL-WST)

2-Wire Serial MPU Interface

(I²C-Compatible And Fast I²C)

I²C Registers Synchronized to VSYNC

GENERAL DESCRIPTION

The ADV7192 is an integrated Digital Video Encoder that converts digital CCIR-601/656 4:2:2 8-bit or 16-bit component video data into a standard analog baseband television signal compatible with worldwide standards. Additionally, it is possible

to input video data in 3x 10-bit YCrCb progressive scan format to facilitate interfacing devices such as progressive scan systems.

Six DACs are available on the ADV7192, each of which is capable of providing 4.33 mA of current. In addition to the composite output signal there is the facility to output S-Video (Y/C Video), RGB Video and YUV Video. All YUV formats (SMPTE/EBU N10, MII or Betacam) are supported.

The on-board SSAF (Super Subalias Filter) with extended luminance frequency response and sharp stopband attenuation enables studio quality video playback on modern TVs, giving optimal horizontal line resolution. An additional sharpness control feature allows high-frequency enhancement on the luminance signal.

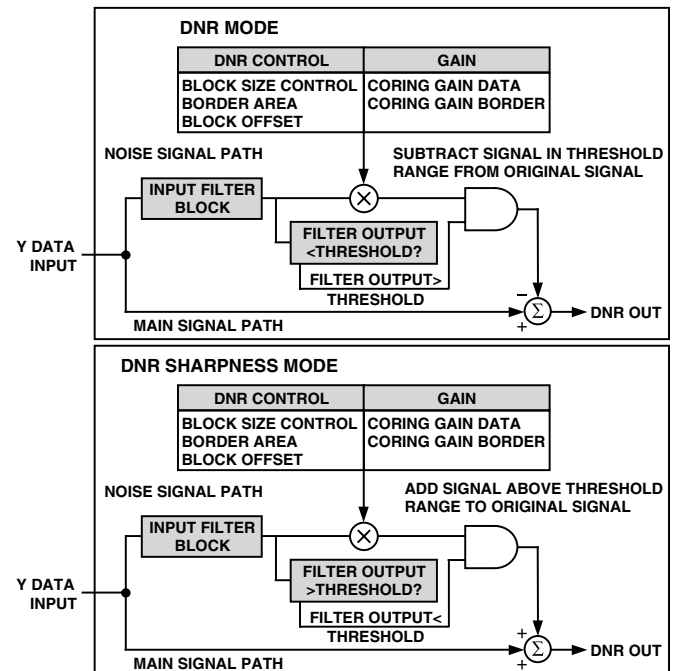

Figure 6. Block Diagram for DNR Mode and DNR Sharpness Mode

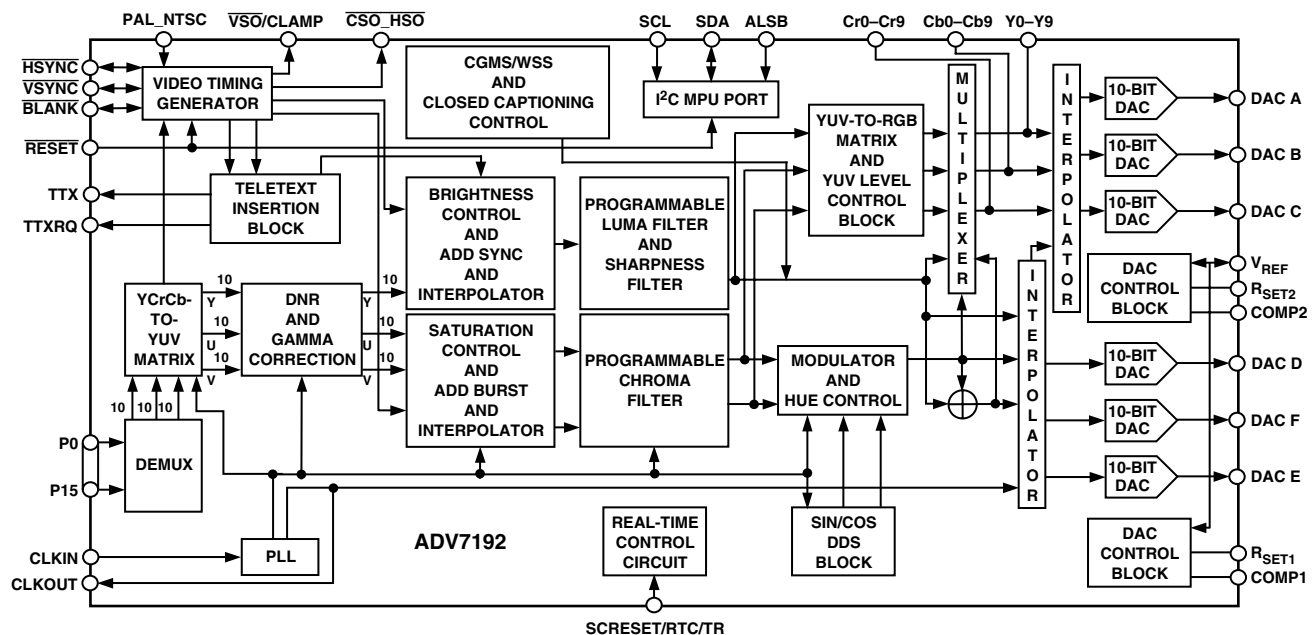

Figure 5. Detailed Functional Block Diagram

ADV7192

Digital Noise Reduction allows improved picture quality in removing low amplitude, high frequency noise. Figure 6 shows the DNR functionality in the two modes available.

Programmable gamma correction is also available. The figure below shows the response of different gamma values to a ramp signal.

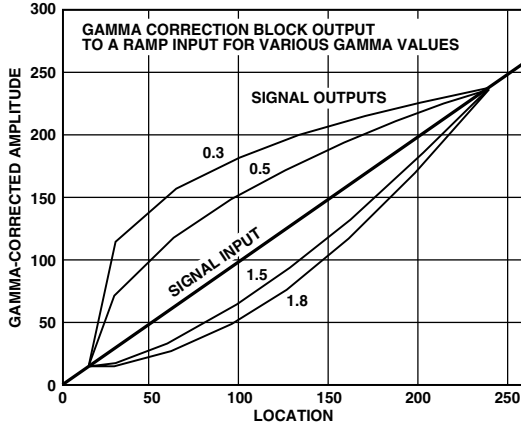

Figure 7. Signal Input (Ramp) and Selectable Gamma Output Curves

The device is driven by a 27 MHz clock. Data can be output at 27 MHz or 54 MHz (on-board PLL) when 4× oversampling is enabled. Also, the output filter requirements in 4× oversampling and 2× oversampling differ, as can be seen in Figure 8.

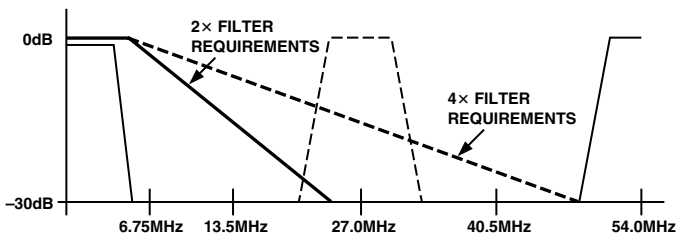

Figure 8. Output Filter Requirements in 4× Oversampling Mode

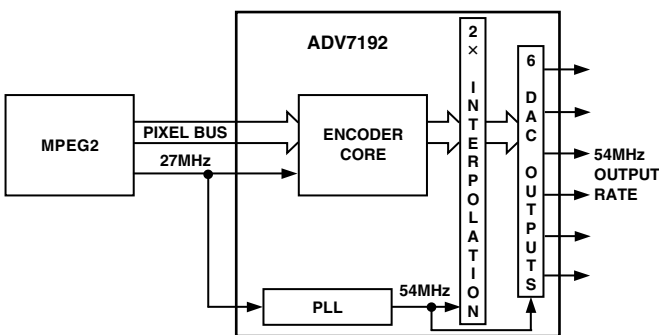

Figure 9. PLL and 4× Oversampling Block Diagram

The ADV7192 also supports both PAL and NTSC square pixel operation. In this case the encoder requires a 24.5454 MHz Clock for NTSC or 29.5 MHz Clock for PAL square pixel mode operation. All internal timing is generated on-chip.

An advanced power management circuit enables optimal control of power consumption in normal operating modes or sleep modes.

The Output Video Frames are synchronized with the incoming data Timing Reference Codes. Optionally, the Encoder accepts (and can generate) $\overline{\text{HSYNC}}$, $\overline{\text{VSYNC}}$, and FIELD timing signals. These timing signals can be adjusted to change pulsewidth and position while the part is in master mode.

$\overline{\text{HSO/CSO}}$ and $\overline{\text{VSO}}$ TTL outputs are also available and are timed to the analog output video.

A separate teletext port enables the user to directly input teletext data during the vertical blanking interval.

The ADV7192 also incorporates WSS and CGMS-A data control generation.

The ADV7192 modes are set up over a 2-wire serial bidirectional port (I²C-compatible) with two slave addresses, and the device is register-compatible with the ADV7172.

The ADV7192 is packaged in an 80-lead LQFP package.

DATA PATH DESCRIPTION

For PAL B, D, G, H, I, M, N, and NTSCM, N modes, YCrCb 4:2:2 data is input via the CCIR-656/601-compatible Pixel Port at a 27 MHz Data Rate. The Pixel Data is demultiplexed to form three data paths. Y typically has a range of 16 to 235, Cr and Cb typically have a range of 128 ± 112 ; however, it is possible to input data from 1 to 254 on both Y, Cb, and Cr. The ADV7192 supports PAL (B, D, G, H, I, N, M) and NTSCM, N (with and without Pedestal) and PAL60 standards.

Digital noise reduction can be applied to the Y signal. Programmable gamma correction can also be applied to the Y signal if required.

The Y data can be manipulated for contrast control and a setup level can be added for brightness control. The Cr, Cb data can be scaled to achieve color saturation control. All settings become effective at the start of the next field when double buffering is enabled.

The appropriate sync, blank, and burst levels are added to the YCrCb data. Macrovision antitaping, closed-captioning and teletext levels are also added to Y and the resultant data is interpolated to 54 MHz (4× Oversampling Mode). The interpolated data is filtered and scaled by three digital FIR filters.

The U and V signals are modulated by the appropriate Subcarrier Sine/Cosine waveforms and a phase offset may be added onto the color subcarrier during active video to allow hue adjustment. The resulting U and V signals are added together to make up the Chrominance signal. The Luma (Y) signal can be delayed by up to six clock cycles (at 27 MHz) and the Chroma signal can be delayed by up to eight clock cycles (at 27 MHz).

The Luma and Chroma signals are added together to make up the Composite Video Signal. All timing signals are controlled.

The YCrCb data is also used to generate RGB data with appropriate sync and blank levels. The YUV levels are scaled to output the suitable SMPTE/EBU N10, MII, or Betacam levels.

Each DAC can be individually powered off if not required. A complete description of DAC output configurations is given in the Mode Register 2 section.

Video output levels are illustrated in Appendix 9.

When used to interface progressive scan systems, the ADV7192 allows input to YCrCb signals in Progressive Scan format (3× 10-bit) before these signals are routed to the interpolation filters and the DACs.

INTERNAL FILTER RESPONSE

The Y Filter supports several different frequency responses including two low-pass responses, two notch responses, an Extended (SSAF) response with or without gain boost/attenuation, a CIF response, and a QCIF response. The UV/filter supports

several different frequency responses including five low-pass responses, a CIF response, and a QCIF response, as can be seen in the following figures. All filter plots show the 4× Oversampling responses.

In Extended Mode there is the option of 12 responses in the range from -4 dB to +4 dB. The desired response can be chosen by the user by programming the correct value via the I²C. The variation of frequency responses can be seen in the Tables I and II. For more detailed filter plots refer to Analog Devices' Application Note AN-562.

Table I. Luminance Internal Filter Specifications (4× Oversampling)

Filter Type	Filter Selection			Passband Ripple ¹ (dB)	3 dB Bandwidth ² (MHz)	Stopband Cutoff ³ (MHz)	Stopband Attenuation ⁴ (dB)
	MR04	MR03	MR02				
Low-Pass (NTSC)	0	0	0	0.16	4.24	6.05	-75.2
Low-Pass (PAL)	0	0	1	0.1	4.81	6.41	-64.6
Notch (NTSC)	0	1	0	0.09	2.3/4.9/6.6	8.03	-87.3
Notch (PAL)	0	1	1	0.1	3.1/5.6/6.4	8.02	-79.7
Extended (SSAF)	1	0	0	0.04	6.45	8.03	-86.6
CIF	1	0	1	0.127	3.02	5.04	-62.6
QCIF	1	1	0	Monotonic	1.5	3.74	-88.2

NOTES

¹Passband Ripple is defined as the fluctuations from the 0 dB response in the passband, measured in (dB). The passband is defined to have 0–f_c frequency limits for a low-pass filter, 0–f₁ and f₂–infinity for a notch filter, where f_c, f₁, f₂ are the -3 dB points.

²3 dB bandwidth refers to the -3 dB cutoff frequency.

³Stopband Cutoff refers to the frequency at the attenuation point referred to under Note 4.

⁴Stopband Attenuation refers to the attenuation point (dB) at the frequency referred to under Note 3.

Table II. Chrominance Internal Filter Specifications (4× Oversampling)

Filter Type	Filter Selection			Passband Ripple ¹ (dB)	3 dB Bandwidth ² (MHz)	Stopband Cutoff ³ (MHz)	Stopband Attenuation ⁴ (dB)
	MR07	MR06	MR05				
1.3 MHz Low-Pass	0	0	0	0.09	1.395	2.46	-83.9
0.65 MHz Low-Pass	0	0	1	Monotonic	0.65	2.41	-71.1
1.0 MHz Low-Pass	0	1	0	Monotonic	1.0	1.89	-64.43
2.0 MHz Low-Pass	0	1	1	0.048	2.2	3.1	-65.9
3.0 MHz Low-Pass	1	0	0	Monotonic	3.2	5.3	-84.5
CIF	1	0	1	Monotonic	0.65	2.41	-71.1
QCIF	1	1	0	Monotonic	0.5	1.75	-33.1

NOTES

¹Passband Ripple is defined as the fluctuations from the 0 dB response in the passband, measured in (dB). The passband is defined to have 0–f_c frequency limits for a low-pass filter, 0–f₁ and f₂–infinity for a notch filter, where f_c, f₁, f₂ are the -3 dB points.

²3 dB bandwidth refers to the -3 dB cutoff frequency.

³Stopband Cutoff refers to the frequency at the attenuation point referred to under Note 4.

⁴Stopband Attenuation refers to the attenuation point (dB) at the frequency referred to under Note 3.

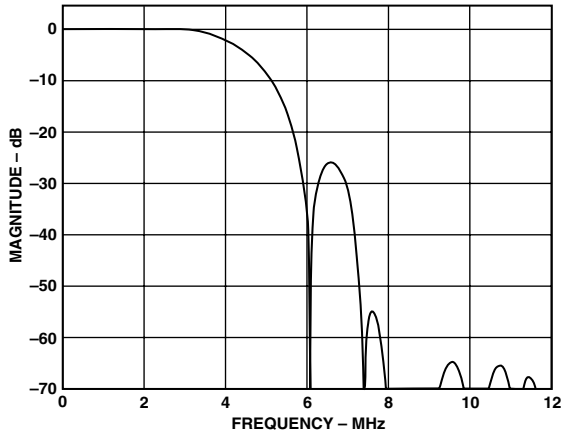

Figure 10. NTSC Low-Pass Luma Filter

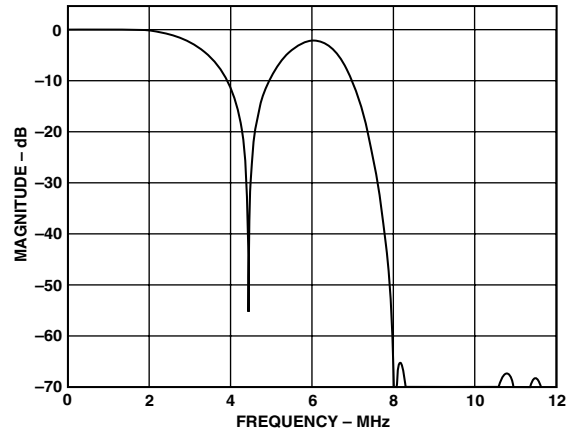

Figure 13. PAL Notch Luma Filter

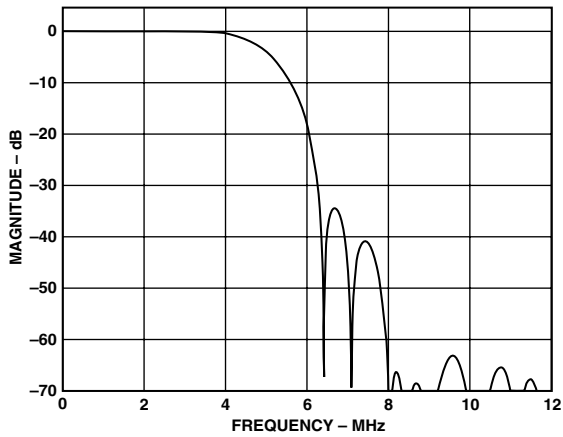

Figure 11. PAL Low-Pass Luma Filter

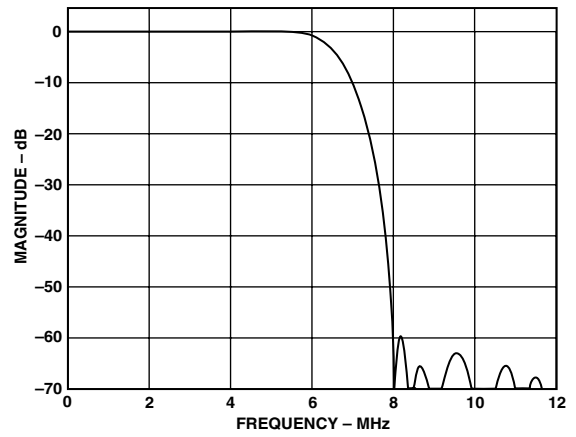

Figure 14. Extended Mode (SSAF) Luma Filter

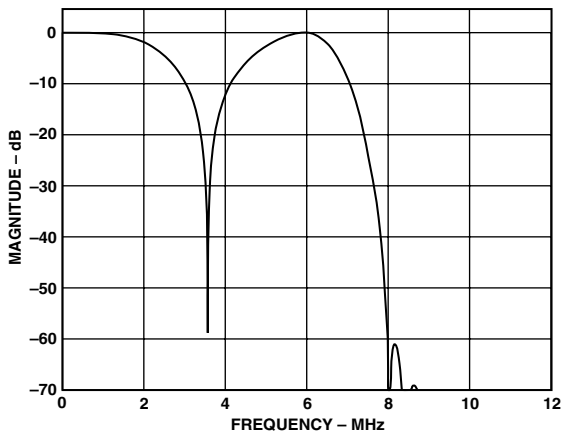

Figure 12. NTSC Notch Luma Filter

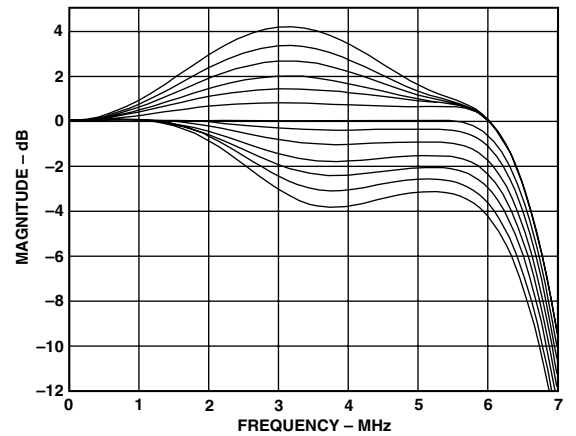

Figure 15. Extended SSAF Luma Filter and Programmable Gain/Attenuation Showing +4 dB/-12 dB Range

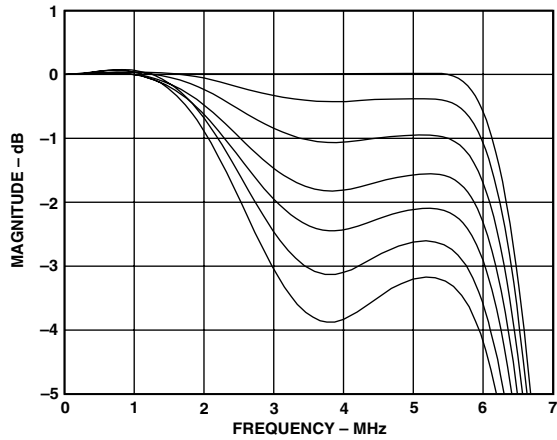

Figure 16. Extended SSAF and Programmable Attenuation, Showing Range 0 dB/-4 dB

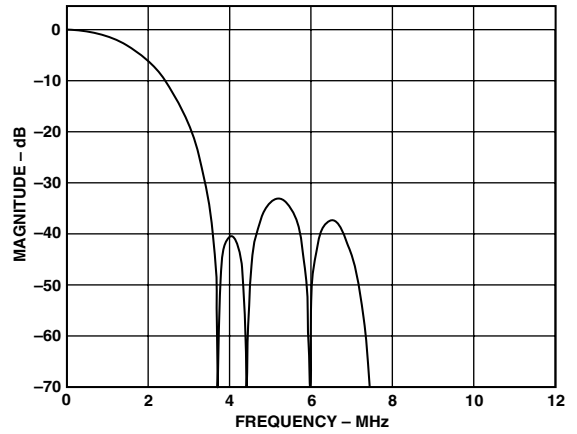

Figure 19. Luma QCIF Filter

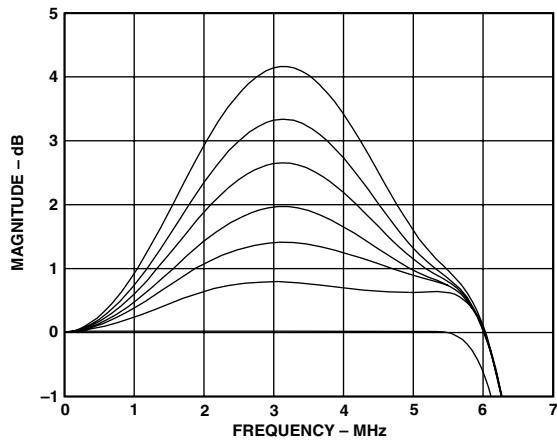

Figure 17. Extended SSAF and Programmable Gain, Showing Range 0 dB/+4 dB

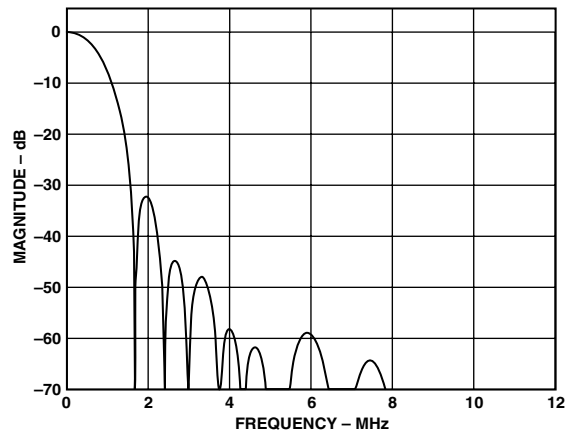

Figure 20. Chroma 0.65 MHz Low-Pass Filter

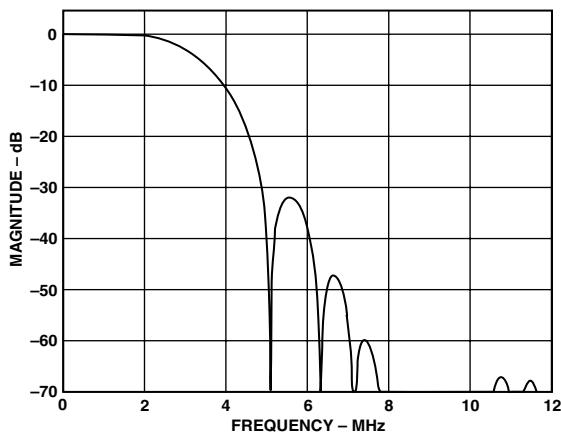

Figure 18. Luma CIF Filter

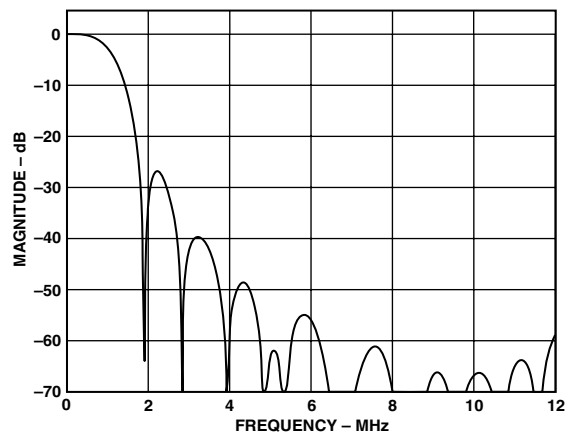

Figure 21. Chroma 1.0 MHz Low-Pass Filter

ADV7192

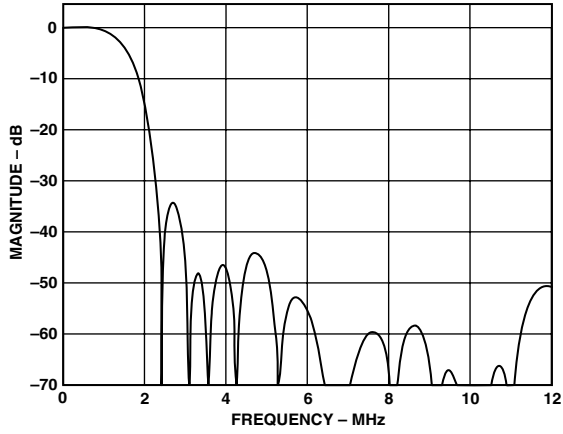

Figure 22. Chroma 1.3 MHz Low-Pass Filter

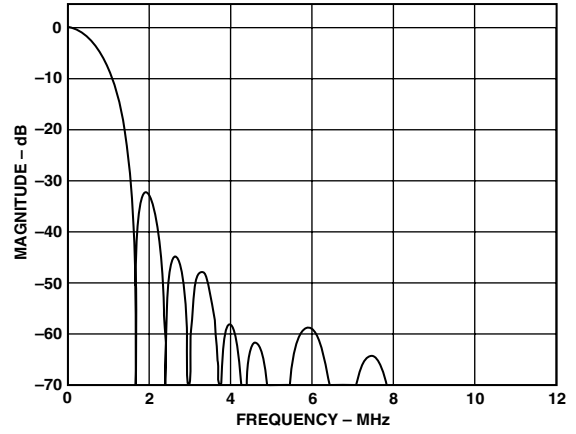

Figure 25. Chroma CIF Filter

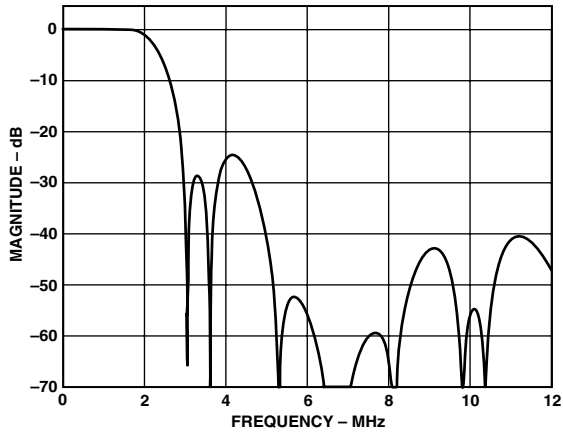

Figure 23. Chroma 2 MHz Low-Pass Filter

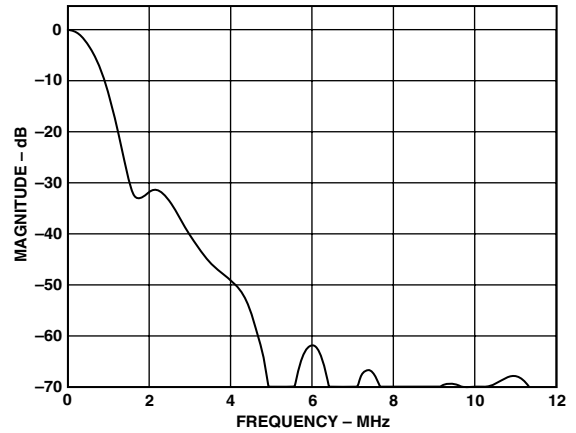

Figure 26. Chroma QCIF Filter

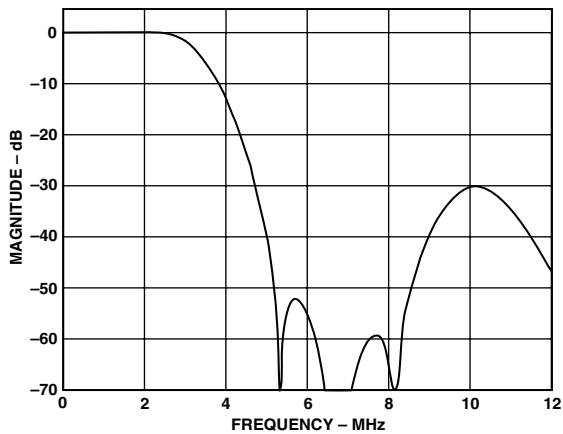

Figure 24. Chroma 3 MHz Low-Pass Filter

FEATURES: FUNCTIONAL DESCRIPTION

BLACK BURST OUTPUT

It is possible to output a black burst signal from two DACs. This signal output is very useful for professional video equipment since it enables two video sources to be locked together. (Mode Register 9.)

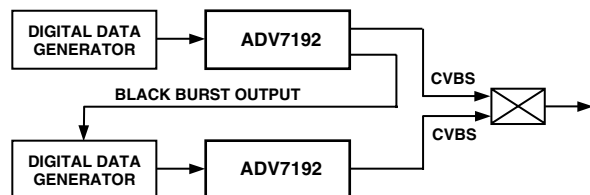

Figure 27. Possible Application for the Black Burst Output Signal

BRIGHTNESS DETECT

This feature is used to monitor the average brightness of the incoming Y video signal on a field by field basis. The information is read from the I²C and based on this information the color saturation, contrast and brightness controls can be adjusted (for example to compensate for very dark pictures). (Brightness Detect Register.)

CHROMA/LUMA DELAY

The luminance data can be delayed by maximum of six clock cycles. Additionally the Chroma can be delayed by a maximum of eight clock cycles (one clock cycle at 27 MHz). (Timing Register 0 and Mode Register 9.)

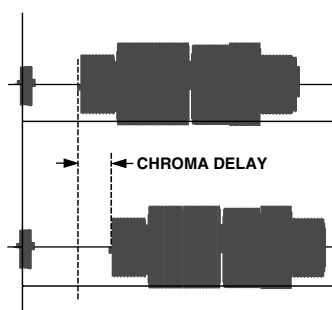

Figure 28. Chroma Delay

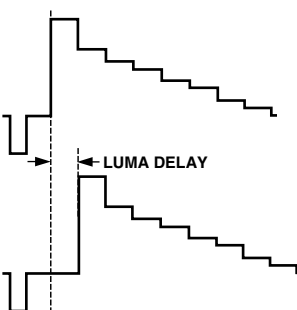

Figure 29. Luma Delay

CLAMP OUTPUT

The ADV7192 has a programmable clamp TTL output signal. This clamp signal is programmable to the front and back porch. The clamp signal can be varied by one to three clock cycles in a positive and negative direction from the default position. (Mode Register 5, Mode Register 7.)

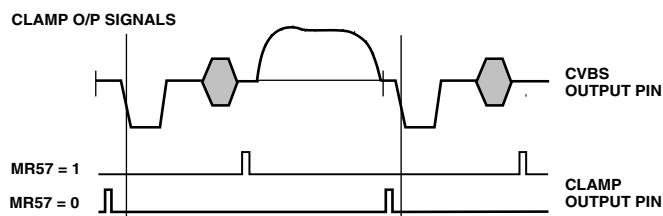

Figure 30. Clamp Output Timing

\overline{CSO} , \overline{HSO} AND \overline{VSO} OUTPUTS

The ADV7192 supports three output timing signals, \overline{CSO} (composite sync signal), \overline{HSO} (Horizontal Sync Signal) and \overline{VSO} (Vertical Sync Signal). These output TTL signals are aligned with the analog video outputs. See Figure 31 for an example of these waveforms. (Mode Register 7.)

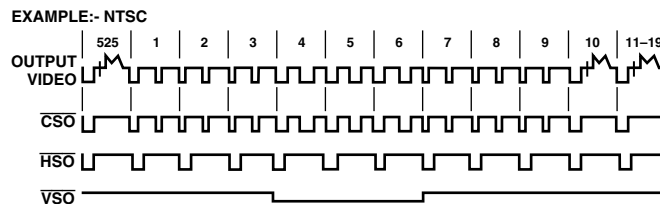

Figure 31. \overline{CSO} , \overline{HSO} , \overline{VSO} Timing Diagram

COLOR BAR GENERATION

The ADV7192 can be configured to generate 100/7.5/75/7.5 color bars for NTSC or 100/0/75/0 color bars for PAL. (Mode Register 4.)

COLOR BURST SIGNAL CONTROL

The burst information can be switched on and off the composite and chroma video output. (Mode Register 4.)

COLOR CONTROLS

The ADV7192 allows the user to control the brightness, contrast, hue and saturation of the color. The control registers may be double-buffered, meaning that any modification to the registers will be done outside the active video region and, therefore, changes made will not be visible during active video.

Contrast Control

Contrast adjustment is achieved by scaling the Y input data by a factor programmed by the user. This factor allows the data to be scaled between 0% and 150%. (Contrast Control Register.)

Brightness Control

The brightness is controlled by adding a programmable setup level onto the scaled Y data. This brightness level may be added onto the Y data. For NTSC with pedestal, the setup can vary from 0 IRE to 22.5 IRE. For NTSC without pedestal and PAL, the setup can vary from -7.5 IRE to +15 IRE. (Brightness Control Register.)

Color Saturation

Color adjustment is achieved by scaling the Cr and Cb input data by a factor programmed by the user. This factor allows the data to be scaled between 0% and 200%. (U Scale Register and V Scale Register.)

Hue Adjust Control

The hue adjustment is achieved on the composite and chroma outputs by adding a phase offset onto the color subcarrier in the active video but leaving the color burst unmodified, i.e., only the phase between the video and the colorburst is modified and hence the hue is shifted. The ADV7192 provides a range of $\pm 22^\circ$ in increments of 0.17578125° . (Hue Adjust Register.)

CHROMINANCE CONTROL

The color information can be switched on and off the composite, chroma and color component video outputs. (Mode Register 4.)

ADV7192

UNDERSHOOT LIMITER

A limiter is placed after the digital filters. This prevents any synchronization problems for TVs. The level of undershoot is programmable between -1.5 IRE, -6 IRE, -11 IRE when operating in $4\times$ Oversampling Mode. In $2\times$ Oversampling Mode the limits are -7.5 IRE and 0 IRE. (Mode Register 9 and Timing Register 0.)

DIGITAL NOISE REDUCTION

DNR is applied to the Y data only. A filter block selects the high frequency, low amplitude components of the incoming signal (DNR Input Select). The absolute value of the filter output is compared to a programmable threshold value (DNR Threshold Control). There are two DNR modes available: DNR Mode and DNR Sharpness Mode.

In DNR Mode, if the absolute value of the filter output is smaller than the threshold, it is assumed to be noise. A programmable amount (Coring Gain Control) of this noise signal will be subtracted from the original signal.

In DNR Sharpness Mode, if the absolute value of the filter output is less than the programmed threshold, it is assumed to be noise, as before. Otherwise, if the level exceeds the threshold, now being identified as a valid signal, a fraction of the signal (Coring Gain Control) will be added to the original signal in order to boost high frequency components and to sharpen the video image.

In MPEG systems it is common to process the video information in blocks of 8×8 pixels for MPEG2 systems, or 16×16 pixels for MPEG1 systems ('Block Size Control'). DNR can be applied to the resulting block transition areas that are known to contain noise. Generally the block transition area contains two pixels. It is possible to define this area to contain four pixels (Border Area Control).

It is also possible to compensate for variable block positioning or differences in YCrCb pixel timing with the use of the Block Offset Control. (Mode Register 8, DNR Registers 0–2.)

DOUBLE BUFFERING

Double buffering can be enabled or disabled on the following registers: Closed Captioning Registers, Brightness Control Register, V-Scale, U-Scale Contrast Control Register, Hue Adjust Register, Macrovision Registers, and the Gamma Curve Select bit. These registers are updated once per field on the falling edge of the \overline{VSYNC} signal. Double Buffering improves the overall performance of the ADV7192, since modifications to register settings will not be made during active video, but take effect on the start of the active video. (Mode Register 8.)

GAMMA CORRECTION CONTROL

Gamma correction may be performed on the luma data. The user has the choice to use either of two different gamma curves, A or B. At any one time one of these curves is operational if gamma correction is enabled. Gamma correction allows the mapping of the luma data to a user-defined function. (Mode Register 8, Gamma Correction Registers 0–13.)

NTSC PEDESTAL CONTROL

In NTSC mode it is possible to have the pedestal signal generated on the output video signal. (Mode Register 2.)

POWER-ON RESET

After power-up, it is necessary to execute a \overline{RESET} operation. A reset occurs on the falling edge of a high-to-low transition on the \overline{RESET} pin. This initializes the pixel port such that the data on the pixel inputs pins is ignored. See Appendix 8 for the register settings after \overline{RESET} is applied.

PROGRESSIVE SCAN INPUT

It is possible to input data to the ADV7192 in progressive scan format. For this purpose the input pins Y0/P8–Y7/P15, Y8–Y9, Cr0–Cr9 and Cb0–Cb9 accept 10-bit Y data, 10-bit Cb data and 10-bit Cr data. The data is clocked into the part at 27 MHz. The data is then filtered and sinc corrected in an $2\times$ Interpolation filter and then output to three video DACs at 54 MHz (to interface to a progressive scan monitor).

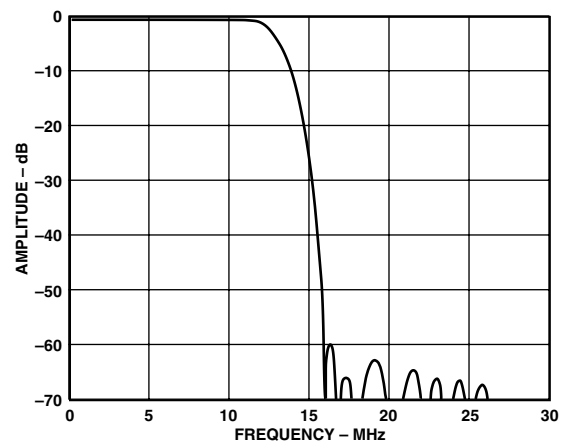

Figure 32. Plot of the Interpolation Filter for the Y Data

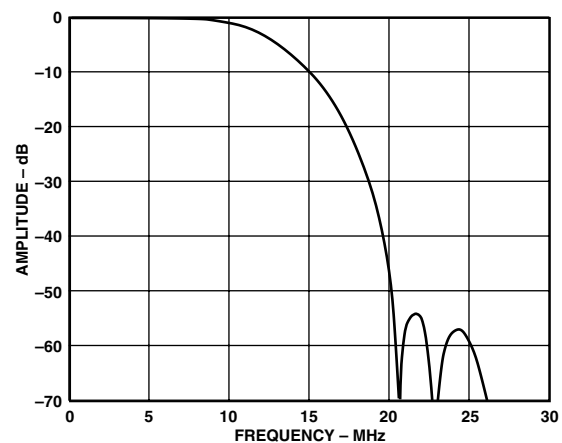

Figure 33. Plot of the Interpolation Filter for the CrCb Data

It is assumed that there is no color space conversion or any other such operation to be performed on the incoming data. Thus if these DAC outputs are to drive a TV, all relevant timing and synchronization data should be contained in the incoming digital Y data.

The block diagram below shows a possible configuration for progressive scan mode using the ADV7192.

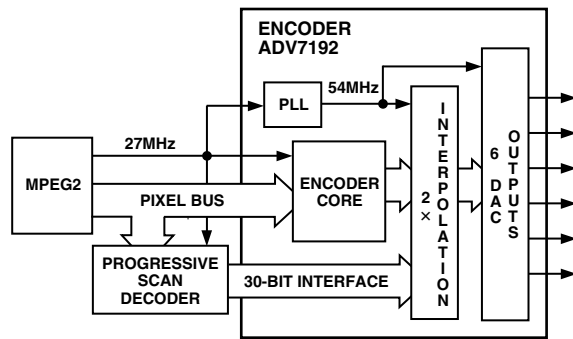

Figure 34. Block Diagram Using the ADV7192 in Progressive Scan Mode

The progressive scan decoder deinterlaces the data from the MPEG2 decoder. This now means that there are 525 video lines per field in NTSC mode and 625 video lines per field in PAL mode. The duration of the video line is now 32 μ s.

It is important to note that the data from the MPEG2 decoder is in 4:2:2 format. The data output from the progressive scan decoder is in 4:4:4 format. Thus it is assumed that some form of interpolation on the color component data is performed in the progressive scan decoder IC. (Mode Register 8.)

REAL-TIME CONTROL, SUBCARRIER RESET, AND TIMING RESET

Together with the SCRESET/RTC/TR pin and Mode Register 4 (Genlock Control), the ADV7192 can be used in (a) Timing Reset Mode, (b) Subcarrier Phase Reset Mode or (c) RTC Mode.

- A TIMING RESET is achieved in holding this pin high. In this state the horizontal and vertical counters will remain reset. On releasing this pin (set to low), the internal counters will commence counting again. The minimum time the pin has to be held high is 37 ns (1 clock cycle at 27 MHz), otherwise the reset signal might not be recognized.
- The SUBCARRIER PHASE will reset to that of Field 0 at the start of the following field when a low to high transition occurs on this input pin.
- In RTC MODE, the ADV7192 can be used to lock to an external video source.

The real-time control mode allows the ADV7192 to automatically alter the subcarrier frequency to compensate for line length variations. When the part is connected to a device that outputs a digital datastream in the RTC format (such as an ADV7185 video decoder, see Figure 38), the part will automatically change to the compensated subcarrier frequency on a line-by-line basis. This digital datastream is 67 bits wide and the subcarrier is contained in Bits 0 to 21. Each bit is two clock cycles long. 00Hex should be written into all four Subcarrier Frequency registers when using this mode. (Mode Register 4.)

SCH PHASE MODE

The SCH phase is configured in default mode to reset every four (NTSC) or eight (PAL) fields to avoid an accumulation of SCH phase error over time. In an ideal system, zero SCH phase error would be maintained forever, but in reality, this is impossible to achieve due to clock frequency variations. This effect is reduced by the use of a 32-bit DDS, which generates this SCH.

Resetting the SCH phase every four or eight fields avoids the accumulation of SCH phase error, and results in very minor SCH phase jumps at the start of the four or eight field sequence.

Resetting the SCH phase should not be done if the video source does not have stable timing or the ADV7192 is configured in RTC mode. Under these conditions (unstable video) the Subcarrier Phase Reset should be enabled but no reset applied. In this configuration the SCH Phase will never be reset; this means that the output video will now track the unstable input video. The Subcarrier Phase Reset when applied will reset the SCH phase to Field 0 at the start of the next field (e.g., Subcarrier Phase Reset applied in Field 5 (PAL) on the start of the next field SCH phase will be reset to Field 0). (Mode Register 4.)

SLEEP MODE

If, after $\overline{\text{RESET}}$, the SCRESET/RTC/TR and NTSC_PAL pins are both set high, the ADV7192 will power up in Sleep Mode to facilitate low power consumption before all registers have been initialized.

If Power-up in Sleep Mode is disabled, Sleep Mode control passes to the Sleep Mode control in Mode Register 2 (i.e., control via I²C). (Mode Register 2 and Mode Register 6.)

SQUARE PIXEL MODE

The ADV7192 can be used to operate in square pixel mode. For NTSC operation an input clock of 24.5454 MHz is required. Alternatively, for PAL operation, an input clock of 29.5 MHz is required. The internal timing logic adjusts accordingly for square pixel mode operation. Square pixel mode is not available in 4 \times Oversampling mode. (Mode Register 2.)

VERTICAL BLANKING DATA INSERTION AND $\overline{\text{BLANK}}$ INPUT

It is possible to allow encoding of incoming YCbCr data on those lines of VBI that do not have line sync or pre-/post-equalization pulses. This mode of operation is called *Partial Blanking*. It allows the insertion of any VBI data (Opened VBI) into the encoded output waveform, this data is present in digitized incoming YCbCr data stream (e.g., WSS data, CGMS, VPS etc.). Alternatively the entire VBI may be blanked (no VBI data inserted) on these lines. VBI is available in all timing modes.

The complete VBI is comprised of the following lines:

525/60 systems, Lines 525 to 21 for field one and Lines 262 to Line 284 for field two.

625/50 systems, Lines 624 to Line 22 and Lines 311 to 335.
The "Opened VBI" consists of:

525/60 systems, Lines 10 to 21 for field one and second half of Line 273 to Line 284 for field two.

625/50 systems, Lines 7 to 22 and Lines 319 to 335.
(Mode Register 3.)

It is possible to allow control over the $\overline{\text{BLANK}}$ signal using Timing Register 0. When the $\overline{\text{BLANK}}$ input is enabled (TR03 = 0 and input pin tied low), the $\overline{\text{BLANK}}$ input can be used to input externally generated blank signals in Slave Mode 1, 2, or 3. When the $\overline{\text{BLANK}}$ input is disabled (TR03 = 1 and input pin tied low or tied high) the $\overline{\text{BLANK}}$ input is not used and the ADV7192 automatically blanks all normally blank lines as per CCIR-624. (Timing Register 0.)

ADV7192

YUV LEVELS

This functionality allows the ADV7192 to output SMPTE levels or Betacam levels on the Y output when configured in PAL or NTSC mode.

	Sync	Video
Betacam	286 mV	714 mV
SMPTE	300 mV	700 mV
MII	300 mV	700 mV

As the data path is branched at the output of the filters, the luma signal relating to the CVBS or S-Video Y/C output is unaltered. Only the Y output of the YCrCb outputs is scaled. This control allows color component levels to have a peak-peak amplitude of 700 mV, 1000 mV or the default values of 934 mV in NTSC and 700 mV in PAL. (Mode Register 5.)

16-BIT INTERFACE

It is possible to input data in 16-bit format. In this case, the interface only operates if the data is accompanied by separate $\overline{\text{HSYNC}}$ / $\overline{\text{VSYNC}}$ / $\overline{\text{BLANK}}$ signals. Sixteen-bit mode is not available in Slave Mode 0 since EAV/SAV timing codes are used. (Mode Register 8.)

4× OVERSAMPLING AND INTERNAL PLL

It is possible to operate all six DACs at 27 MHz (2× Oversampling) or 54 MHz (4× Oversampling).

The ADV7192 is supplied with a 27 MHz clock synced with the incoming data. Two options are available: to run the device throughout at 27 MHz or to enable the PLL. In the latter case, even if the incoming data runs at 27 MHz, 4× Oversampling and the internal PLL will output the data at 54 MHz.

NOTE

In 4× Oversampling Mode the requirements for the optional output filters are different from those in 2× Oversampling. (Mode Register 1, Mode Register 6.) See Appendix 6.

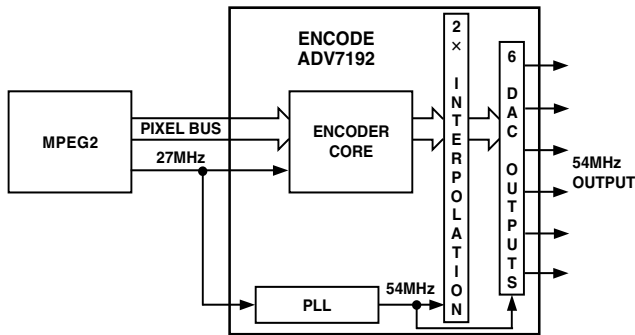

Figure 35. PLL and 4× Oversampling Block Diagram

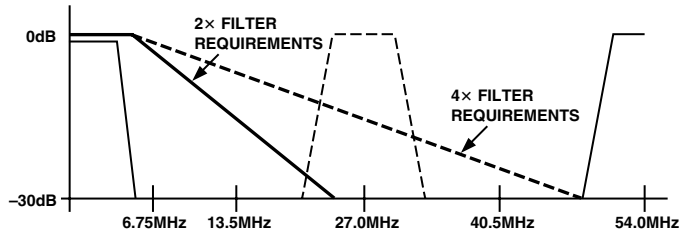

Figure 36. Output Filter Requirements in 2× and 4× Oversampling Mode

VIDEO TIMING DESCRIPTION

The ADV7192 is intended to interface to off-the-shelf MPEG1 and MPEG2 Decoders. As a consequence, the ADV7192 accepts 4:2:2 YCrCb Pixel Data via a CCIR-656 Pixel Port and has several Video Timing Modes of operation that allow it to be configured as either System Master Video Timing Generator or a Slave to the System Video Timing Generator. The ADV7192 generates all of the required horizontal and vertical timing periods and levels for the analog video outputs.

The ADV7192 calculates the width and placement of analog sync pulses, blanking levels, and color burst envelopes. Color bursts are disabled on appropriate lines and serration and equalization pulses are inserted where required.

In addition the ADV7192 supports a PAL or NTSC square pixel operation. The part requires an input pixel clock of 24.5454 MHz for NTSC square pixel operation and an input pixel clock of 29.5 MHz for PAL square pixel operation. The internal horizontal line counters place the various video waveform sections in the correct location for the new clock frequencies.

The ADV7192 has four distinct Master and four distinct Slave timing configurations. Timing Control is established with the bidirectional $\overline{\text{HSYNC}}$, $\overline{\text{BLANK}}$ and $\overline{\text{VSYNC}}$ pins. Timing Register 1 can also be used to vary the timing pulsewidths and where they occur in relation to each other. (Mode Register 2, Timing Register 0, 1.)

RESET SEQUENCE

When $\overline{\text{RESET}}$ becomes active the ADV7192 reverts to the default output configuration (see Appendix 8 for register settings). The ADV7192 internal timing is under the control of the logic level on the NTSC_PAL pin.

When $\overline{\text{RESET}}$ is released Y, Cr, Cb values corresponding to a black screen are input to the ADV7192. Output timing signals are still suppressed at this stage. DACs A, B, C are switched off and DACs D, E, F are switched on.

When the user requires valid data, Pixel Data Valid Control is enabled (MR26 = 1) to allow the valid pixel data to pass through the encoder. Digital output timing signals become active and the encoder timing is now under the control of the Timing Registers. If at this stage, the user wishes to select a different video standard to that on the NTSC_PAL pin, Standard I²C Control should be enabled (MR25 = 1) and the video standard required is selected by programming Mode Register 0 (Output Video Standard Selection). Figure 37 illustrates the $\overline{\text{RESET}}$ sequence timing.

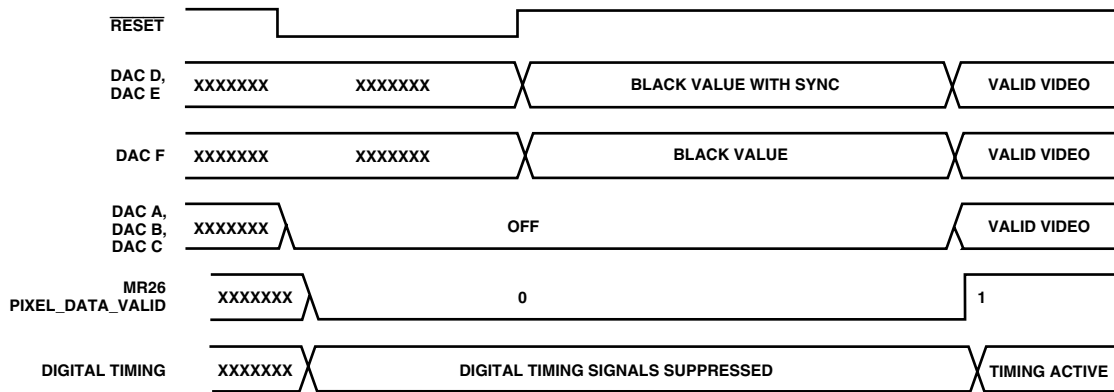

Figure 37. \overline{RESET} Sequence Timing Diagram

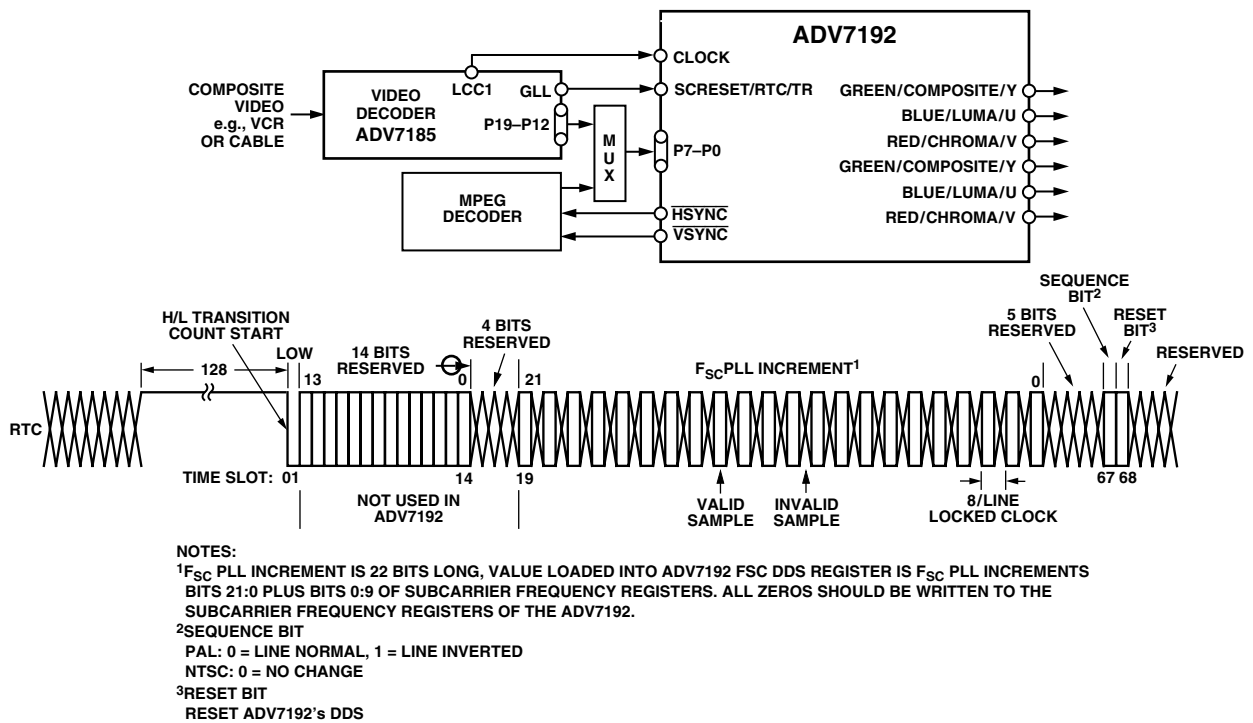

Figure 38. RTC Timing and Connections

ADV7192

Mode 0 (CCIR-656): Slave Option

(Timing Register 0 TR0 = X X X X X 0 0 0)

The ADV7192 is controlled by the SAV (Start Active Video) and EAV (End Active Video) Time Codes in the Pixel Data. All timing information is transmitted using a 4-byte Synchronization Pattern. A synchronization pattern is sent immediately before and after each line during active picture and retrace. Mode 0 is illustrated in Figure 39. The HSYNC, VSYNC and BLANK (if not used) pins should be tied high during this mode. Blank output is available.

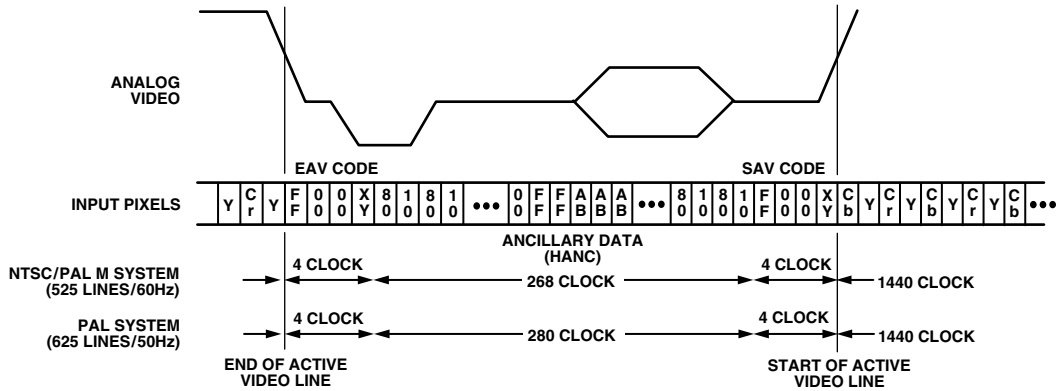

Figure 39. Timing Mode 0, Slave Mode

Mode 0 (CCIR-656): Master Option

(Timing Register 0 TR0 = X X X X X 0 0 1)

The ADV7192 generates H, V, and F signals required for the SAV (Start Active Video) and EAV (End Active Video) Time Codes in the CCIR656 standard. The H bit is output on the HSYNC pin, the V bit is output on the BLANK pin and the F bit is output on the VSYNC pin. Mode 0 is illustrated in Figure 40 (NTSC) and Figure 41 (PAL). The H, V, and F transitions relative to the video waveform are illustrated in Figure 42.

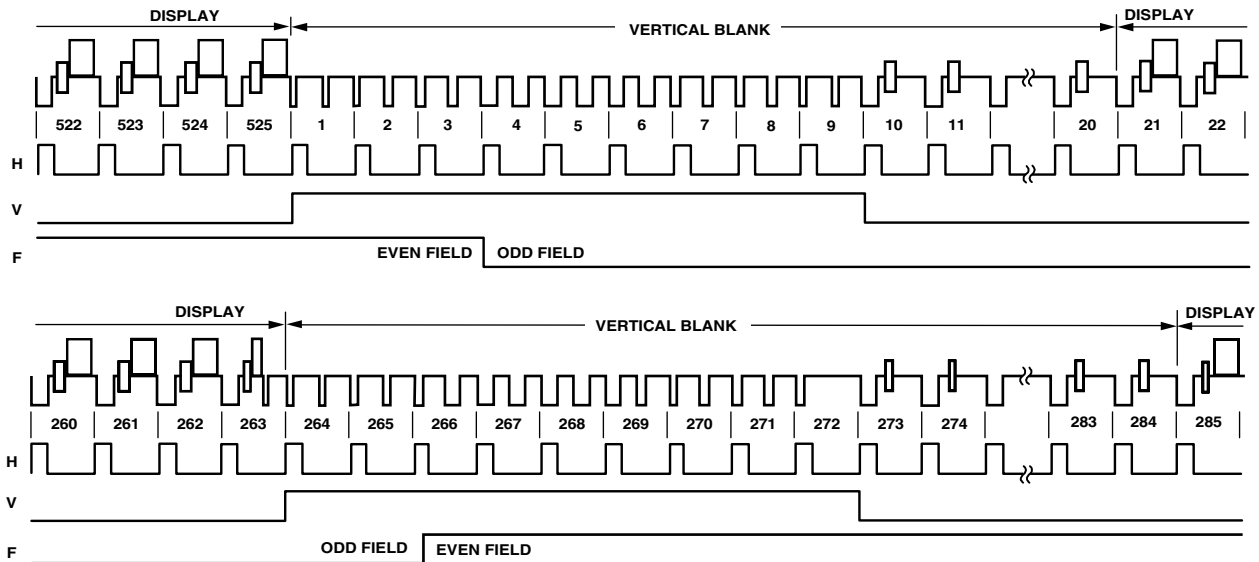

Figure 40. Timing Mode 0, NTSC Master Mode

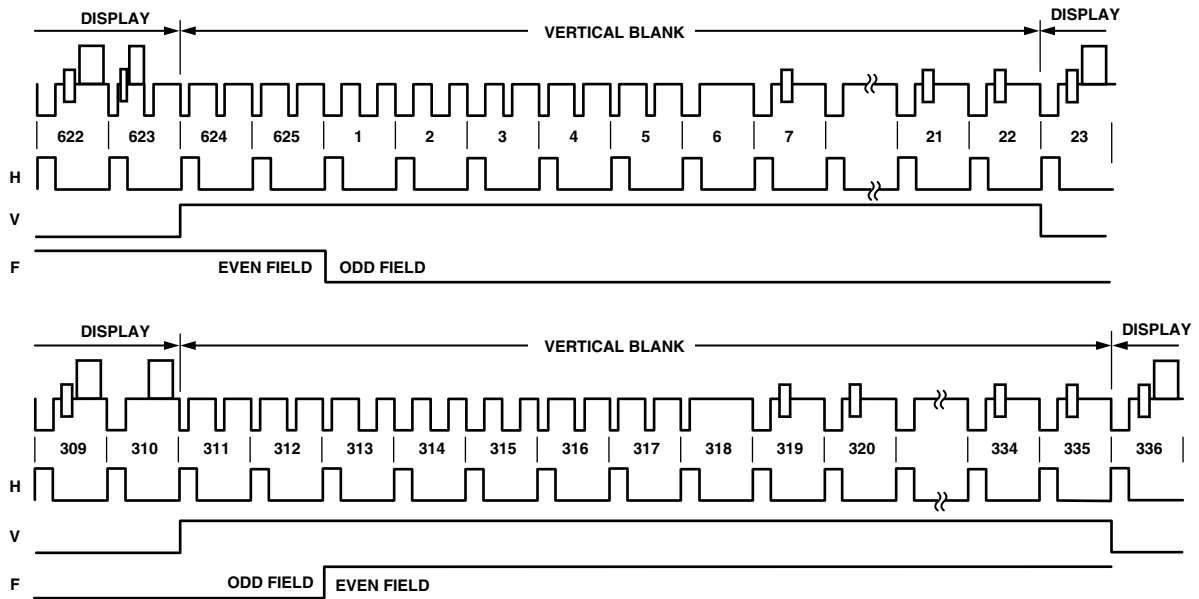

Figure 41. Timing Mode 0, PAL Master Mode

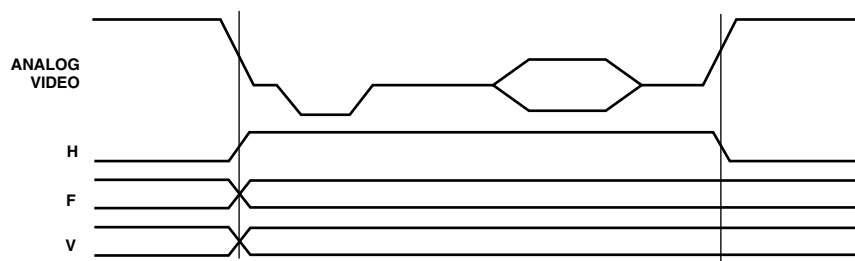

Figure 42. Timing Mode 0 Data Transitions, Master Mode

ADV7192

Mode 1: Slave Option $\overline{\text{HSYNC}}$, $\overline{\text{BLANK}}$, FIELD

(Timing Register 0 TR0 = X X X X X 0 1 0)

In this mode the ADV7192 accepts Horizontal SYNC and Odd/ Even FIELD signals. A transition of the FIELD input when $\overline{\text{HSYNC}}$ is low indicates a new frame, i.e., Vertical Retrace. The $\overline{\text{BLANK}}$ signal is optional. When the $\overline{\text{BLANK}}$ input is disabled the ADV7192 automatically blanks all normally blank lines as per CCIR-624. Mode 1 is illustrated in Figure 43 (NTSC) and Figure 44 (PAL).

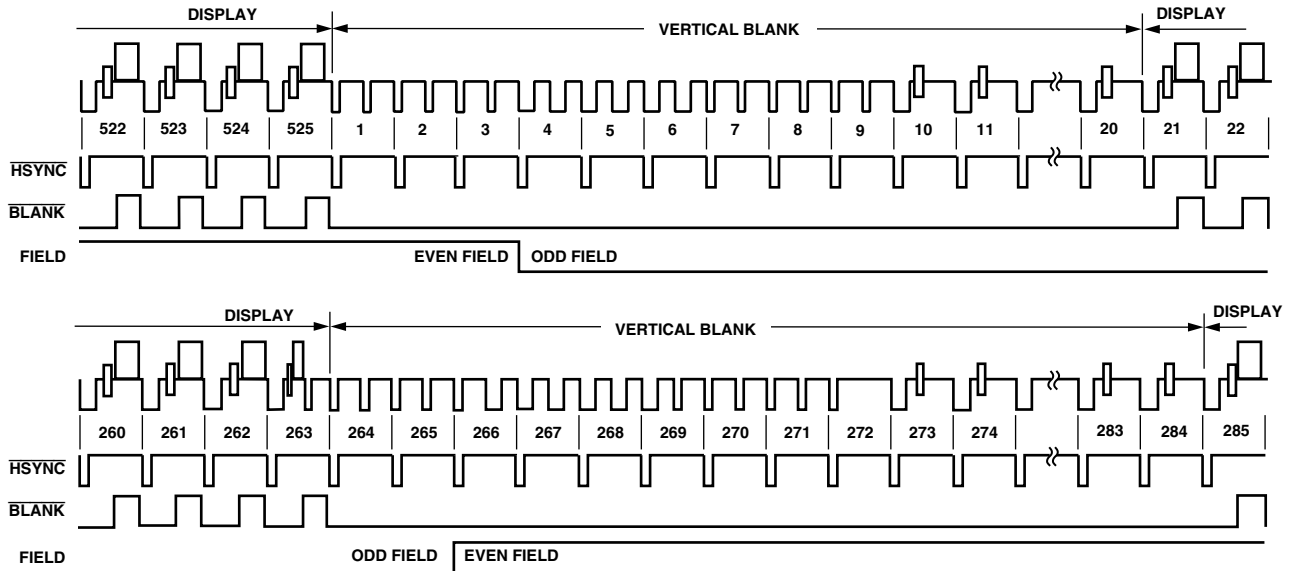

Figure 43. Timing Mode 1, NTSC

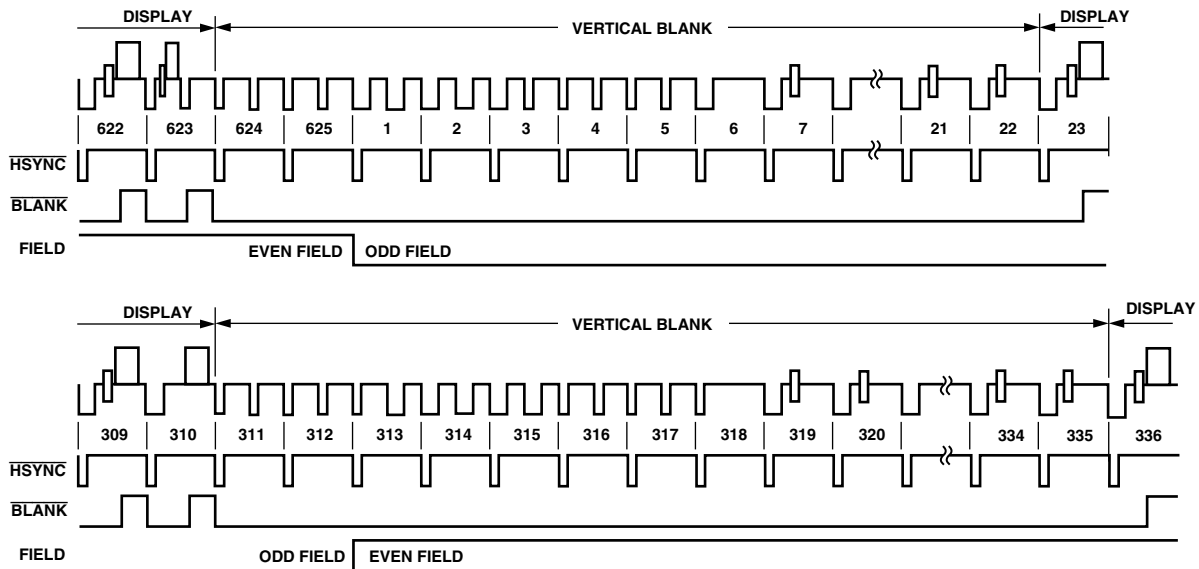

Figure 44. Timing Mode 1, PAL

Mode 1: Master Option $\overline{\text{HSYNC}}$, $\overline{\text{BLANK}}$, FIELD

(Timing Register 0 TR0 = X X X X X 0 1 1)

In this mode the ADV7192 can generate Horizontal SYNC and Odd/Even FIELD signals. A transition of the FIELD input when $\overline{\text{HSYNC}}$ is low indicates a new frame i.e., Vertical Retrace. The $\overline{\text{BLANK}}$ signal is optional. When the $\overline{\text{BLANK}}$ input is disabled the ADV7192 automatically blanks all normally blank lines as per CCIR-624. Pixel data is latched on the rising clock edge following the timing signal transitions. Mode 1 is illustrated in Figure 43 (NTSC) and Figure 44 (PAL). Figure 45 illustrates the $\overline{\text{HSYNC}}$, $\overline{\text{BLANK}}$ and FIELD for an odd or even field transition relative to the pixel data.

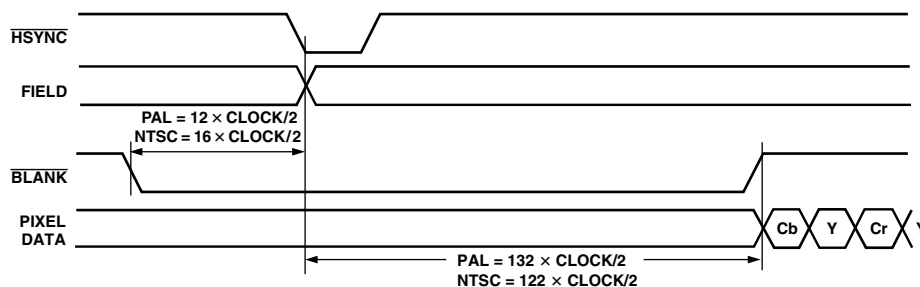

Figure 45. Timing Mode 1 Odd/Even Field Transitions Master/Slave

Mode 2: Slave Option $\overline{\text{HSYNC}}$, $\overline{\text{VSYNC}}$, $\overline{\text{BLANK}}$

(Timing Register 0 TR0 = X X X X X 1 0 0)

In this mode the ADV7192 accepts Horizontal and Vertical SYNC signals. A coincident low transition of both $\overline{\text{HSYNC}}$ and $\overline{\text{VSYNC}}$ inputs indicates the start of an Odd Field. A $\overline{\text{VSYNC}}$ low transition when $\overline{\text{HSYNC}}$ is high indicates the start of an Even Field. The $\overline{\text{BLANK}}$ signal is optional. When the $\overline{\text{BLANK}}$ input is disabled the ADV7192 automatically blanks all normally blank lines as per CCIR-624. Mode 2 is illustrated in Figure 46 (NTSC) and Figure 47 (PAL).

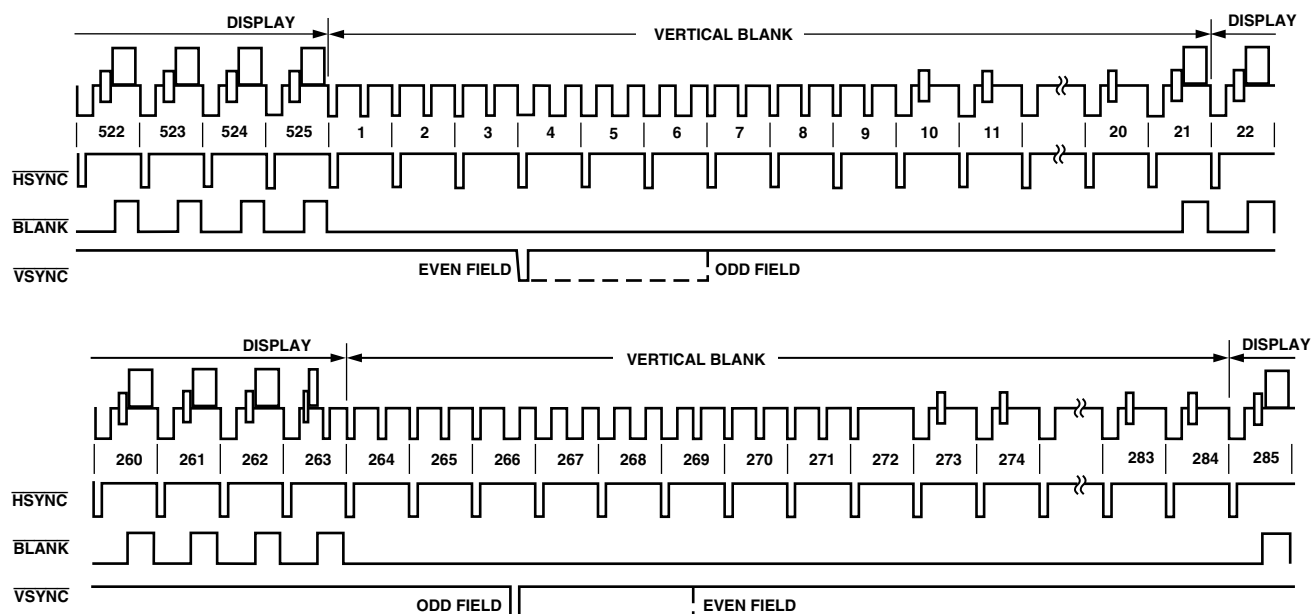

Figure 46. Timing Mode 2, NTSC

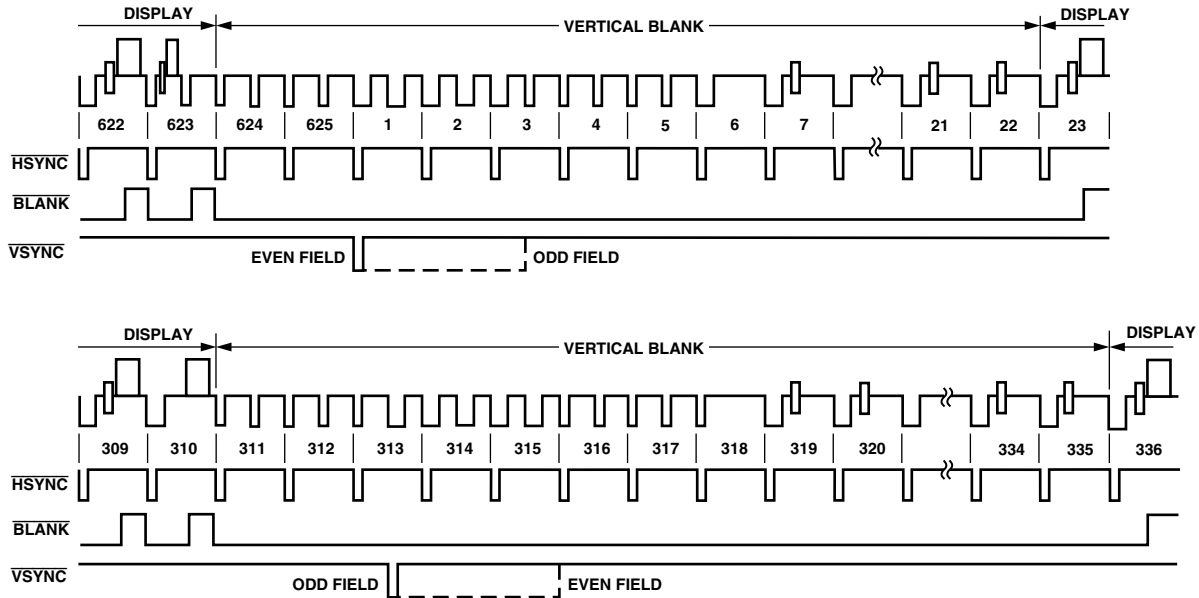

Figure 47. Timing Mode 2, PAL

Mode 2: Master Option $\overline{\text{HSYNC}}$, $\overline{\text{VSYNC}}$, $\overline{\text{BLANK}}$

(Timing Register 0 TR0 = X X X X X 1 0 1)

In this mode the ADV7192 can generate Horizontal and Vertical SYNC signals. A coincident low transition of both $\overline{\text{HSYNC}}$ and $\overline{\text{VSYNC}}$ inputs indicates the start of an Odd Field. A $\overline{\text{VSYNC}}$ low transition when $\overline{\text{HSYNC}}$ is high indicates the start of an Even Field. The $\overline{\text{BLANK}}$ signal is optional. When the $\overline{\text{BLANK}}$ input is disabled the ADV7192 automatically blanks all normally blank lines as per CCIR-624. Mode 2 is illustrated in Figure 46 (NTSC) and Figure 47 (PAL). Figure 48 illustrates the $\overline{\text{HSYNC}}$, $\overline{\text{BLANK}}$ and $\overline{\text{VSYNC}}$ for an even-to-odd field transition relative to the pixel data. Figure 49 illustrates the $\overline{\text{HSYNC}}$, $\overline{\text{BLANK}}$ and $\overline{\text{VSYNC}}$ for an odd-to-even field transition relative to the pixel data.

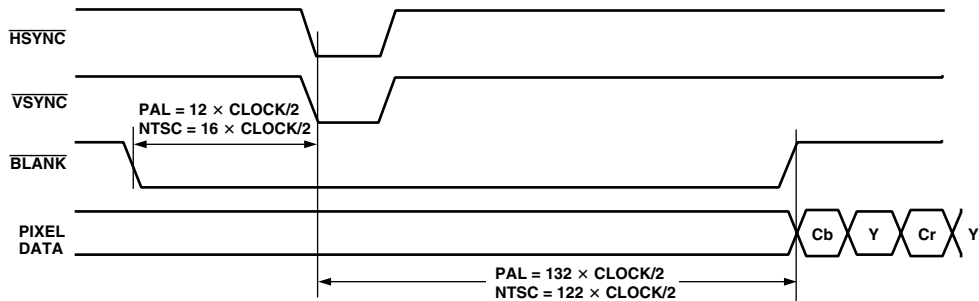

Figure 48. Timing Mode 2, Even-to-Odd Field Transition Master/Slave

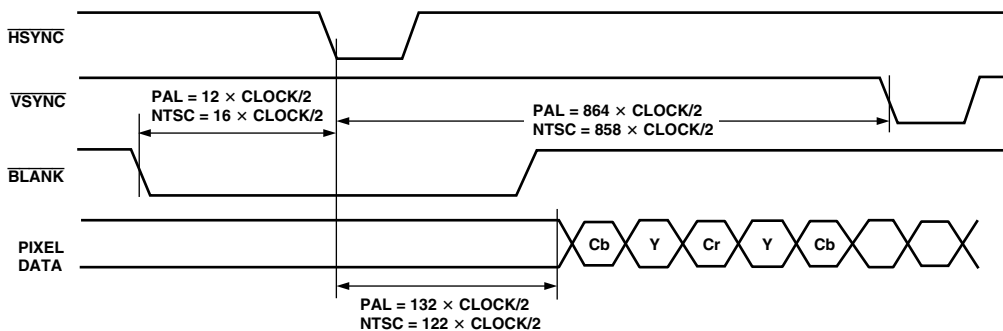

Figure 49. Timing Mode 2, Odd-to-Even Field Transition Master/Slave

Mode 3: Master/Slave Option $\overline{\text{HSYNC}}$, $\overline{\text{BLANK}}$, FIELD

(Timing Register 0 TR0 = X X X X X 1 1 0 or X X X X X 1 1 1)

In this mode the ADV7192 accepts or generates Horizontal SYNC and Odd/Even FIELD signals. A transition of the FIELD input when $\overline{\text{HSYNC}}$ is high indicates a new frame i.e., Vertical Retrace. The $\overline{\text{BLANK}}$ signal is optional. When the $\overline{\text{BLANK}}$ input is disabled the ADV7192 automatically blanks all normally blank lines as per CCIR-624. Mode 3 is illustrated in Figure 50 (NTSC) and Figure 51 (PAL).

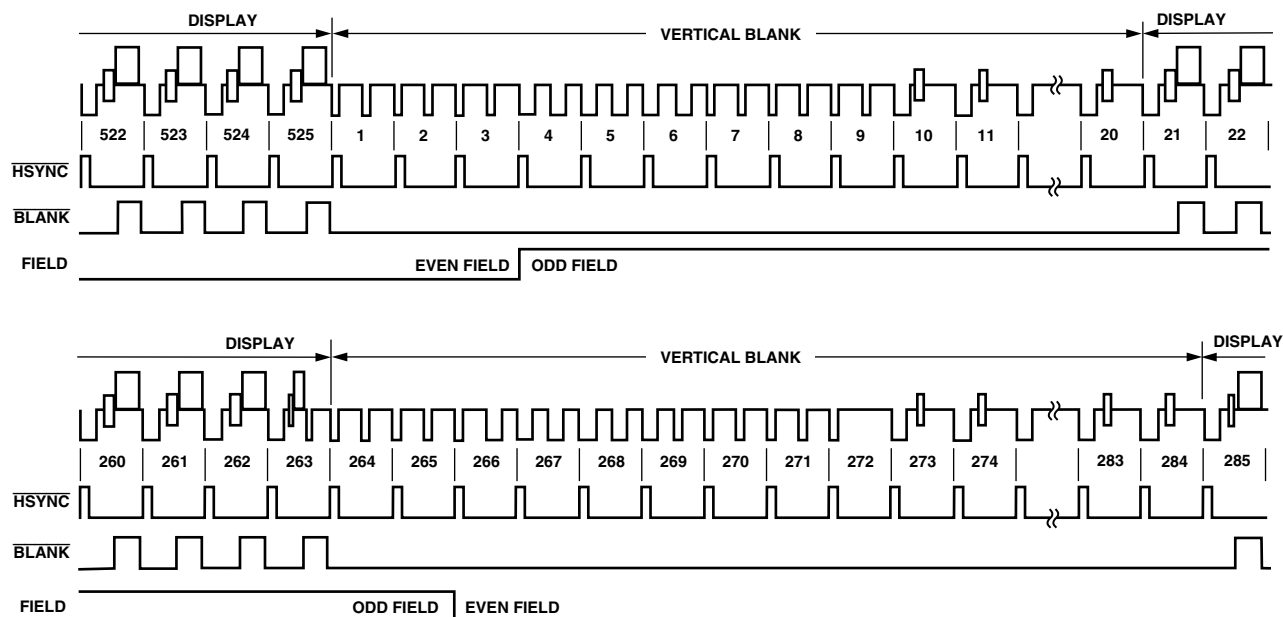

Figure 50. Timing Mode 3, NTSC

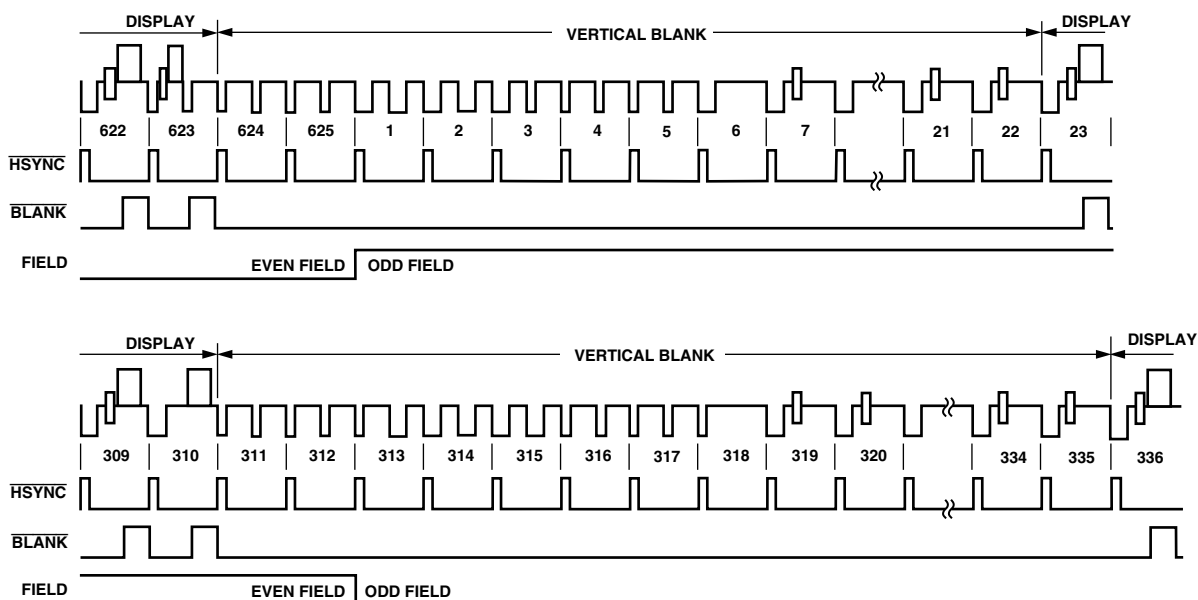

Figure 51. Timing Mode 3, PAL

ADV7192

MPU PORT DESCRIPTION

The ADV7192 support a two-wire serial (I²C-compatible) microprocessor bus driving multiple peripherals. Two inputs, Serial Data (SDA) and Serial Clock (SCL), carry information between any device connected to the bus. Each slave device is recognized by a unique address. The ADV7192 has four possible slave addresses for both read and write operations. These are unique addresses for each device and are illustrated in Figure 52 and Figure 54. The LSB sets either a read or write operation. Logic Level 1 corresponds to a read operation while Logic Level 0 corresponds to a write operation. A1 is set by setting the ALSB pin of the ADV7192 to Logic Level 0 or Logic Level 1. When ALSB is set to 0, there is greater input bandwidth on the I²C lines, which allows high speed data transfers on this bus. When ALSB is set to 1, there is reduced input bandwidth on the I²C lines, which means that pulses of less than 50 ns will not pass into the I²C internal controller. This mode is recommended for noisy systems.

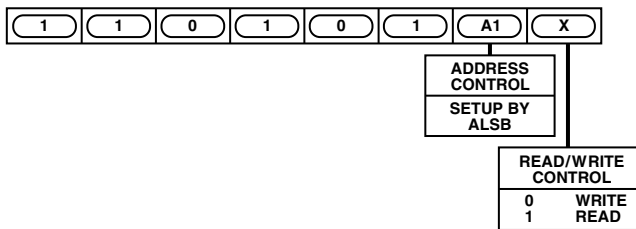

Figure 52. Slave Address

To control the various devices on the bus the following protocol must be followed. First, the master initiates a data transfer by establishing a start condition, defined by a high-to-low transition on SDA while SCL remains high. This indicates that an address/data stream will follow. All peripherals respond to the start condition and shift the next eight bits (7-bit address + R/W bit). The bits are transferred from MSB down to LSB. The peripheral that recognizes the transmitted address responds by pulling the data line low during the ninth clock pulse. This is known as an acknowledge bit. All other devices withdraw from the bus at this point and maintain an idle condition. The idle condition is where the device monitors the SDA and SCL lines waiting for the start condition and the correct transmitted address. The R/W bit determines the direction of the data.

A Logic 0 on the LSB of the first byte means that the master will write information to the peripheral. A Logic 1 on the LSB of the first byte means that the master will read information from the peripheral.

The ADV7192 acts as a standard slave device on the bus. The data on the SDA pin is eight bits long supporting the 7-bit addresses plus the R/W bit. It interprets the first byte as the device address and the second byte as the starting subaddress. The subaddresses autoincrement allowing data to be written to or read from the starting subaddress. A data transfer is always terminated by a stop condition. The user can also access any unique subaddress register on a one-by-one basis without having to update all the registers. There is one exception. The Subcarrier Frequency Registers should be updated in sequence, starting with Subcarrier Frequency Register 0. The autoincrement function should be then used to increment and access Subcarrier Frequency Registers 1, 2, and 3. The Subcarrier Frequency Registers should not be accessed independently.

Stop and start conditions can be detected at any stage during the data transfer. If these conditions are asserted out of sequence with normal read and write operations, then, these cause an immediate jump to the idle condition. During a given SCL high period the user should issue only one start condition, one stop condition, or a single stop condition followed by a single start condition. If an invalid subaddress is issued by the user, the ADV7192 will not issue an acknowledge and will return to the idle condition. If, in autoincrement mode, the user exceeds the highest subaddress, then the following action will be taken:

1. In Read Mode, the highest subaddress register contents will continue to be output until the master device issues a no-acknowledge. This indicates the end of a read. A no-acknowledge condition is where the SDA line is not pulled low on the ninth pulse.
2. In Write Mode, the data for the invalid byte will not be loaded into any subaddress register, a no-acknowledge will be issued by the ADV7192 and the part will return to the idle condition.

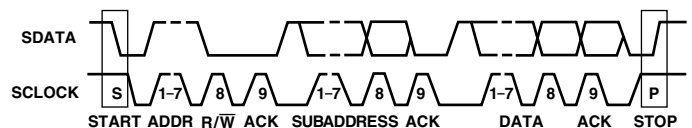

Figure 53. Bus Data Transfer

Figure 53 illustrates an example of data transfer for a read sequence and the start and stop conditions.

Figure 54 shows bus write and read sequences.

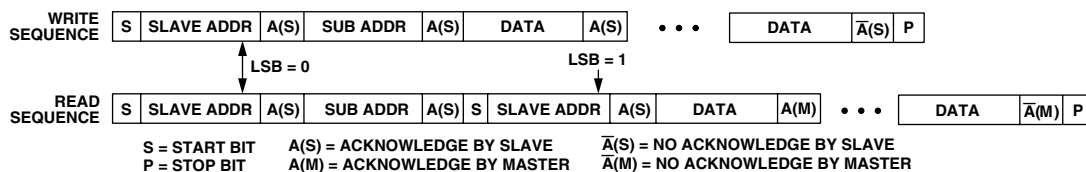

Figure 54. Write and Read Sequences

REGISTER ACCESSES

The MPU can write to or read from all of the registers of the ADV7192 with the exception of the Subaddress Registers which are write only registers. The Subaddress Register determines which register the next read or write operation accesses. All communications with the part through the bus start with an access to the Subaddress Register. Then a read/write operation is performed from/to the target address which then increments to the next address until a stop command on the bus is performed.

REGISTER PROGRAMMING

The following section describes each register. All registers can be read from as well as written to.

Subaddress Register (SR7–SR0)

The Communications Register is an eight bit write-only register. After the part has been accessed over the bus and a read/write operation is selected, the subaddress is set up. The Subaddress Register determines to/from which register the operation takes place.

Figure 55 shows the various operations under the control of the Subaddress Register 0 should always be written to SR7.

Register Select (SR6–SR0)

These bits are set up to point to the required starting address.

SR7	SR6	SR5	SR4	SR3	SR2	SR1	SR0	
SR7	ADV7192 SUBADDRESS REGISTER							
ZERO SHOULD BE WRITTEN HERE	ADDRESS	SR6	SR5	SR4	SR3	SR2	SR1	SR0
	00H	0	0	0	0	0	0	0
	01H	0	0	0	0	0	0	1
	02H	0	0	0	0	0	0	1
	03H	0	0	0	0	0	1	1
	04H	0	0	0	0	1	0	0
	05H	0	0	0	0	1	0	1
	06H	0	0	0	0	1	1	0
	07H	0	0	0	0	1	1	1
	08H	0	0	0	1	0	0	0
	09H	0	0	0	1	0	0	1
	0AH	0	0	0	1	0	1	0
	0BH	0	0	0	1	0	1	1
	0CH	0	0	0	1	1	0	0
	0DH	0	0	0	1	1	0	1
	0EH	0	0	0	1	1	1	0
	0FH	0	0	0	1	1	1	1
	10H	0	0	1	0	0	0	0
	11H	0	0	1	0	0	0	1
	12H	0	0	1	0	0	1	0
	13H	0	0	1	0	0	1	1
	14H	0	0	1	0	1	0	0
	15H	0	0	1	0	1	0	1
	16H	0	0	1	0	1	1	0
	17H	0	0	1	0	1	1	1
	18H	0	0	1	1	0	0	0
	19H	0	0	1	1	0	0	1
	1AH	0	0	1	1	0	1	0
	1BH	0	0	1	1	0	1	1
	1CH	0	0	1	1	1	0	0
	1DH	0	0	1	1	1	0	1
	1EH	0	0	1	1	1	1	0
	1FH	0	0	1	1	1	1	1
	20H	0	1	0	0	0	0	0
	21H	0	1	0	0	0	0	1
	22H	0	1	0	0	0	1	0
	23H	0	1	0	0	0	1	1
	24H	0	1	0	0	1	0	0
	25H	0	1	0	0	1	0	1
	26H	0	1	0	0	1	1	0
	27H	0	1	0	0	1	1	1
	28H	0	1	0	1	0	0	0
	29H	0	1	0	1	0	0	1
	2AH	0	1	0	1	0	1	0
	2BH	0	1	0	1	0	1	1
	2CH	0	1	0	1	1	0	0
	2DH	0	1	0	1	1	0	1
	2EH	0	1	0	1	1	1	0
	2FH	0	1	0	1	1	1	1
	30H	0	1	1	0	0	0	0
	31H	0	1	1	0	0	0	1
	32H	0	1	1	0	0	1	0
	33H	0	1	1	0	0	1	1
	34H	0	1	1	0	1	0	0
	35H	0	1	1	0	1	0	1
	36H	0	1	1	0	1	1	0
	37H	0	1	1	0	1	1	1
	38H	0	1	1	1	0	0	0
	39H	0	1	1	1	0	0	1
	3AH	0	1	1	1	0	1	0
	3BH	0	1	1	1	0	1	1
	3CH	0	1	1	1	1	0	0
	3DH	0	1	1	1	1	0	1
	3EH	0	1	1	1	1	1	0
	3FH	1	1	1	1	1	1	1
	40H	1	0	0	0	0	0	0
	41H	1	0	0	0	0	0	1
	42H	1	0	0	0	0	1	0
	43H	1	0	0	0	0	1	1
	44H	1	0	0	0	1	0	0
	45H	1	0	0	0	1	0	1
	46H	1	0	0	0	1	1	0
	47H	1	0	0	1	1	1	1
	48H	1	0	0	1	0	1	0
	49H	1	0	0	1	0	0	1
	4AH	1	0	0	1	0	0	0
	4BH	1	0	0	1	0	1	1

Figure 55. Subaddress Register for the ADV7192

ADV7192

MODE REGISTER 0

MR0 (MR07–MR00)

(Address (SR4–SR0) = 00H)

Figure 56 shows the various operations under the control of Mode Register 0.

MR0 BIT DESCRIPTION

Output Video Standard Selection Control (MR00–MR01)

These bits are used to set up the encoder mode. The ADV7192 can be set up to output NTSC, PAL (B, D, G, H, I), PAL M or PAL N standard video.

Luminance Filter Select (MR02–MR04)

These bits specify which luma filter is to be selected. The filter selection is made independent of whether PAL or NTSC is selected.

Chrominance Filter Select (MR05–MR07)

These bits select the chrominance filter. A low-pass filter can be selected with a choice of cutoff frequencies (0.65 MHz, 1.0 MHz, 1.3 MHz, 2 MHz, or 3 MHz) along with a choice of CIF or QCIF filters.

MODE REGISTER 1

MR1 (MR17–MR10)

(Address (SR4–SR0) = 01H)

Figure 57 shows the various operations under the control of Mode Register 1.

MR1 BIT DESCRIPTION

DAC Control (MR10–MR15)

Bits MR15–MR10 can be used to power-down the DACs. This are used to reduce the power consumption of the ADV7192 or if any of the DACs are not required in the application.

4× Oversampling Control (MR16)

To enable 4× Oversampling this bit has to be set to 1. When enabled, the data is output at a frequency of 54 MHz.

Note that PLL Enable Control has to be enabled (MR61 = 0) in 4× Oversampling mode. An external V_{REF} is not recommended in that mode.

Reserved (MR17)

A Logical 0 must be written to this bit.

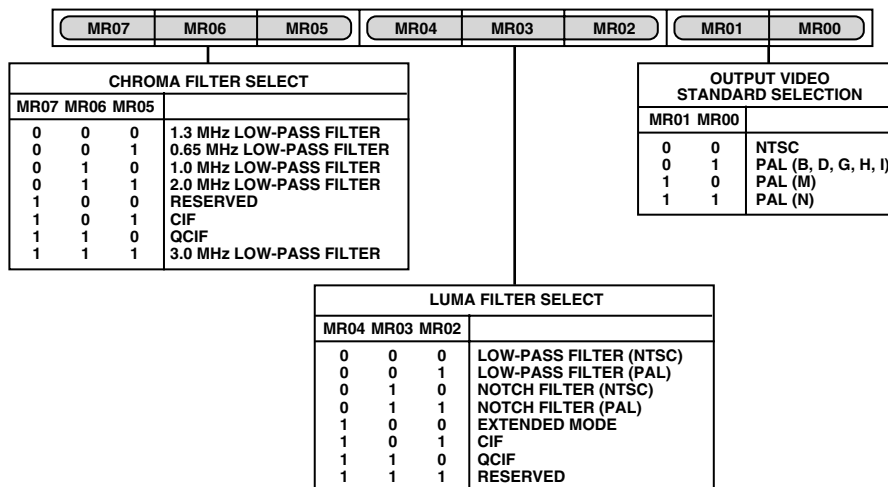

Figure 56. Mode Register 0, MR0

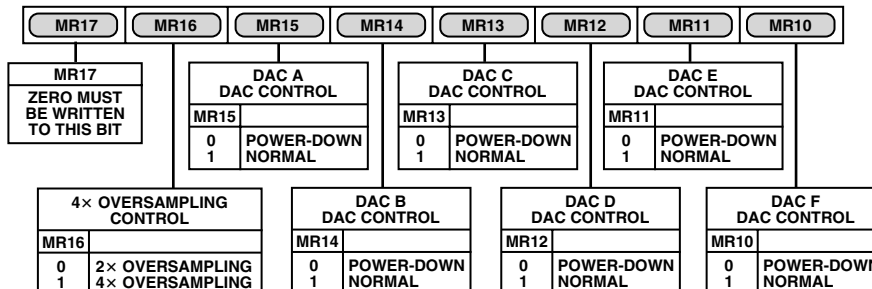

Figure 57. Mode Register 1, MR1

MODE REGISTER 2

MR2 (MR27–MR20)

(Address (SR4–SR0) = 02H)

Mode Register 2 is an 8-bit-wide register.

Figure 58 shows the various operations under the control of Mode Register 2.

MR2 BIT DESCRIPTION—RGB/YUV Control (MR20)

This bit enables the output from the DACs to be set to YUV or RGB output video standard.

DAC Output Control (MR21)

This bit controls the output from DACs A, B, and C. When this bit is set to 1, Composite, Luma and Chroma Signals are output from DACs A, B, and C (respectively). When this bit is set to 0, RGB or YUV may be output from these DACs.

SCART Enable Control (MR22)

This bit is used to switch the DAC outputs from SCART to a EUROSCART configuration. A complete table of all DAC output configurations is shown below.

Pedestal Control (MR23)

This bit specifies whether a pedestal is to be generated on the NTSC composite video signal. This bit is invalid when the device is configured in PAL mode.

Square Pixel Control (MR24)

This bit is used to set up square pixel mode. This is available in Slave Mode only. For NTSC, a 24.54 MHz clock must be supplied. For PAL, a 29.5 MHz clock must be supplied. Square pixel operation is not available in 4× Oversampling mode.

Standard I²C Control (MR25)

This bit controls the video standard used by the ADV7192. When this bit is set to 1 the video standard is as programmed in Mode Register 0 (Output Video Standard Selection). When it is set to 0, the ADV7192 is forced into the standard selected by the NTSC_PAL pin. When NTSC_PAL is low, the standard is NTSC, when the NTSC_PAL pin is high, the standard is PAL.

Pixel Data Valid Control (MR26)

After resetting the device this bit has the value 0 and the pixel data input to the encoder is blanked such that a black screen is output from the DACs. The ADV7192 will be set to Master Mode timing. When this bit is set to 1 by the user (via the I²C), pixel data passes to the pins and the encoder reverts to the timing mode defined by Timing Register 0.

Sleep Mode Control (MR27)

When this bit is set (1), Sleep Mode is enabled. With this mode enabled, the ADV7192 current consumption is reduced to typically 0.1 μA. The I²C registers can be written to and read from when the ADV7192 is in Sleep Mode.

When the device is in Sleep Mode and 0 is written to MR27, the ADV7192 will come out of Sleep Mode and resume normal operation. Also, if a RESET is applied during Sleep Mode the ADV7192 will come out of Sleep Mode and resume normal operation.

For this to operate Power up in Sleep Mode control has to be enabled (MR60 is set to a Logic 0), otherwise Sleep Mode is controlled by the PAL_NTSC and SCRESET/RTC/TR pins.

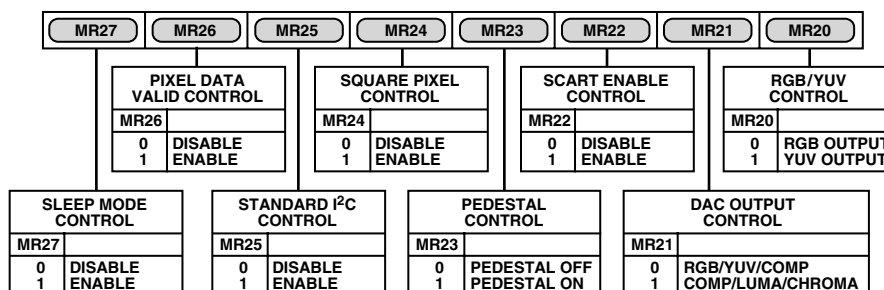

Figure 58. Mode Register 2, MR2

Table III. DAC Output Configuration

MR22	MR21	MR20	DAC A	DAC B	DAC C	DAC D	DAC E	DAC F
0	0	0	G (Y)	B (Pb)	R (Pr)	CVBS	LUMA	CHROMA
0	0	1	Y (Y)	U (Pb)	V (Pr)	CVBS	LUMA	CHROMA
0	1	0	CVBS	LUMA	CHROMA	G (Y)	B (Pb)	R (Pr)
0	1	1	CVBS	LUMA	CHROMA	Y (Y)	U (Pb)	V (Pr)
1	0	0	CVBS	B (Pb)	R (Pr)	G (Y)	LUMA	CHROMA
1	0	1	CVBS	U (Pb)	V (Pr)	Y (Y)	LUMA	CHROMA
1	1	0	CVBS	LUMA	CHROMA	G (Y)	B (Pb)	R (Pr)
1	1	1	CVBS	LUMA	CHROMA	Y (Y)	U (Pb)	V (Pr)

NOTE

In Progressive Scan Mode (MR80 = 1) the DAC output configuration is stated in the brackets.

ADV7192

MODE REGISTER 3

MR3 (MR37–MR30)

(Address (SR4–SR0) = 03H)

Mode Register 3 is an 8-bit-wide register. Figure 59 shows the various operations under the control of Mode Register 3.

MR3 BIT DESCRIPTION

Revision Code (MR30–MR31)

This bit is read only and indicates the revision of the device.

VBI Open (MR32)

This bit determines whether or not data in the Vertical Blanking Interval (VBI) is output to the analog outputs or blanked. Note that this condition is also valid in Timing Slave Mode 0. For further information see Vertical Blanking Data Insertion and $\overline{\text{BLANK}}$ Input section.

Teletext Enable (MR33)

This bit must be set to 1 to enable teletext data insertion on the TTX pin. Note: TTX functionality is shared with $\overline{\text{VSO}}$ and CLAMP on Pin 62. CLAMP/ $\overline{\text{VSO}}$ Select (MR77) and TTX Input/CLAMP- $\overline{\text{VSO}}$ Output (MR76) have to be set accordingly.

Teletext Bit Request Mode Control (MR34)

This bit enables switching of the teletext request signal from a continuous high signal (MR34 = 0) to a bitwise request signal (MR34 = 1).

Closed Captioning Field Selection (MR35–MR36)

These bits control the fields that closed captioning data is displayed on, closed captioning information can be displayed on an odd field, even field or both fields.

Reserved (MR37)

A Logic 0 must be written to this bit.

MODE REGISTER 4

MR4 (MR47–MR40)

(Address (SR4–SR0) = 04H)

Mode Register 4 is an 8-bit-wide register. Figure 60 shows the various operations under the control of Mode Register 4.

MR4 BIT DESCRIPTION

VSYNC_3H Control (MR40)

When this bit is enabled (1) in Slave Mode, it is possible to drive the $\overline{\text{VSYNC}}$ input low for 2.5 lines in PAL mode and three lines in NTSC mode. When this bit is enabled in Master Mode the ADV7192 outputs an active low $\overline{\text{VSYNC}}$ signal for three lines in NTSC mode and 2.5 lines in PAL mode.

Genlock Control (MR41–MR42)

These bits control the Genlock feature and timing reset of the ADV7192. Setting MR41 and MR42 to Logic 0 disables the SCRESET/RTC/TR pin and allows the ADV7192 to operate in normal mode.

1. By setting MR41 to zero and MR42 to one, a timing reset is applied, resetting the horizontal and vertical counters. This has the effect of resetting the Field Count to Field 0.

If the SCRESET/RTC/TR pin is held high, the counters will remain reset. Once the pin is released the counters will commence counting again. For correct counter reset, the SCRESET/RTC/TR pin has to remain high for at least 37 ns (one clock cycle at 27 MHz).

2. If MR41 is set to one and MR42 is set to zero, the SCRESET/RTC/TR pin is configured as a subcarrier reset input and the subcarrier phase will reset to Field 0 whenever a low-to-high transition is detected on the SCRESET/RTC/TR pin (SCH phase resets at the start of the next field).
3. If MR41 is set to one and MR42 is set to one, the SCRESET/RTC/TR pin is configured as a real time control input and the ADV7192 can be used to lock to an external video source working in RTC mode. See Real-Time Control, Subcarrier Reset and Timing Reset section.

Active Video Line Duration (MR43)

This bit switches between two active video line durations. A zero selects CCIR Rec. 601 (720 pixels PAL/NTSC) and a one selects ITU-R BT. 470 standard for active video duration (710 pixels NTSC, 702 pixels PAL).

Chrominance Control (MR44)

This bit enables the color information to be switched on and off the chroma, composite and color component outputs.

Burst Control (MR45)

This bit enables the color burst to be switched on and off the chroma and composite outputs.

Color Bar Control (MR46)

This bit can be used to generate and output an internal color bar test pattern. The color bar configuration is 100/7.5/75/7.5 for NTSC and 100/0/75/0 for PAL. It is important to note that when color bars are enabled the ADV7192 is configured in a Master Timing mode. The output pins $\overline{\text{VSYNC}}$, $\overline{\text{HSYNC}}$ and $\overline{\text{BLANK}}$ are three-state during color bar mode.

Interlaced Mode Control (MR47)

This bit is used to setup the output to interlaced or noninterlaced mode.

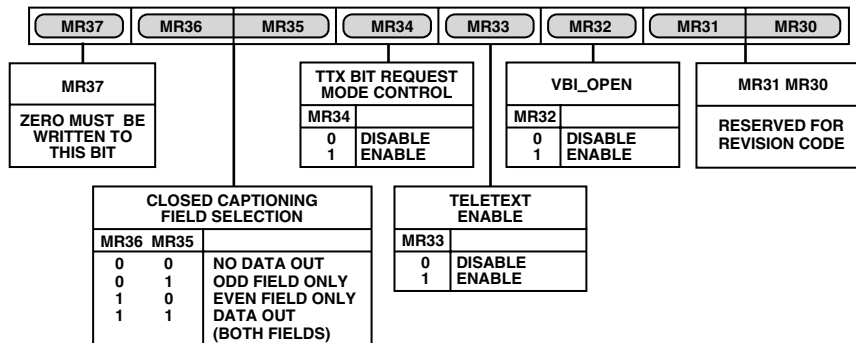

Figure 59. Mode Register 3, MR3

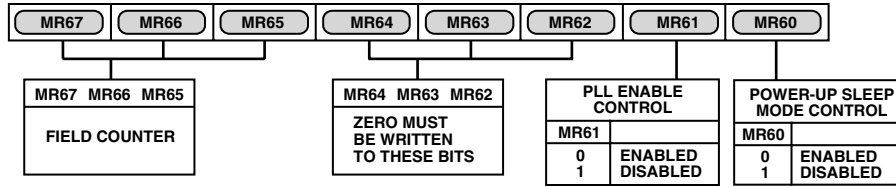

Figure 62. Mode Register 6, MR6

Mode Register 6

MR6 (MR67–MR60)

(Address (SR4–SR0) = 06H)

Mode Register 6 is a 8-bit-wide register. Figure 62 shows the various operations under the control of Mode Register 6.

MR6 BIT DESCRIPTION

Power-Up Sleep Mode Control (MR60)

After RESET is applied this control is enabled (MR60 = 0) if both SCRESET/RTC/TR and NTSC_PAL pins are tied high. The ADV7192 will then power up in Sleep Mode to facilitate low power consumption before the I²C is initialized. When this control is disabled (MR60 = 1, via the I²C) Sleep Mode control passes to Sleep Mode Control, MR27.

PPL Enable Control (MR61)

The PLL control should be enabled (MR61 = 0) when 4× Oversampling is enabled (MR16 = 1). When this bit is toggled, it is also used to reset the PLL.

Reserved (MR62, MR63, MR64)

A Logical 0 must be written to these bits.

Field Counter (MR65, MR66, MR67)

These three bits are read only bits. The field count can be read back over the I²C interface. In NTSC mode the field count goes from 0–3, in PAL Mode from 0–7.

MODE REGISTER 7

MR7 (MR77–MR70)

(Address (SR4–SR0) = 07H)

Mode Register 7 is a 8-bit-wide register. Figure 63 shows the various operations under the control of Mode Register 7.

MR7 BIT DESCRIPTION

Color Control Enable (MR70)

This bit is used to enable control of contrast and saturation of color. If this bit is set (1) color controls are enabled (Contrast Control Register, U-Scale Register, V-Scale Register). If this bit is set (0), the color control features are disabled.

Luma Saturation Control (MR71)

When this bit is set (1), the luma signal will be clipped if it reaches a limit that corresponds to an input luma value of 255 (after scaling by the Contrast Control Register). This prevents the chrominance component of the composite video signal being clipped if the amplitude of the luma is too high. When this bit is set (0), this control is disabled.

Hue Adjust Control (MR72)

This bit is used to enable hue adjustment on the composite and chroma output signals of the ADV7192. When this bit is set (1), the hue of the color is adjusted by the phase offset described in the Hue Adjust Control Register. When this bit is set (0), hue adjustment is disabled.

Brightness Enable Control (MR73)

This bit is used to enable brightness control on the ADV7192. The actual brightness level is programmed in the Brightness Control Register. This value or set-up level is added to the scaled Y data. When this bit is set (1), brightness control is enabled. When this bit is set (0), brightness control is disabled.

Sharpness Filter Enable (MR74)

This bit is used to enable the sharpness control of the luminance signal on the ADV7192 (Luma Filter Select has to be set to Extended, MR04–MR02 = 100). The various responses of the filter are determined by the Sharpness Control Register. When this bit is set (1), the luma response is altered by the amount described in the Sharpness Control Register. When this bit is set (0), the sharpness control is disabled. See Internal Filter Response section for luma signal responses.

CSO_HSO Output Control (MR75)

This bit is used to determine whether $\overline{\text{HSO}}$ or $\overline{\text{CSO}}$ TTL output signal is output at the $\overline{\text{CSO_HSO}}$ pin. If this bit is set (1), the $\overline{\text{CSO}}$ TTL signal is output. If this bit is set (0), the $\overline{\text{HSO}}$ TTL signal is output.

TTX Input/CLAMP–VSO Output (MR76)

This bit controls whether Pin 62 is configured as an output or as an input pin. A 1 selects Pin 62 to be an output for CLAMP or VSO functionality. A 0 selects this pin as a TTX input pin.

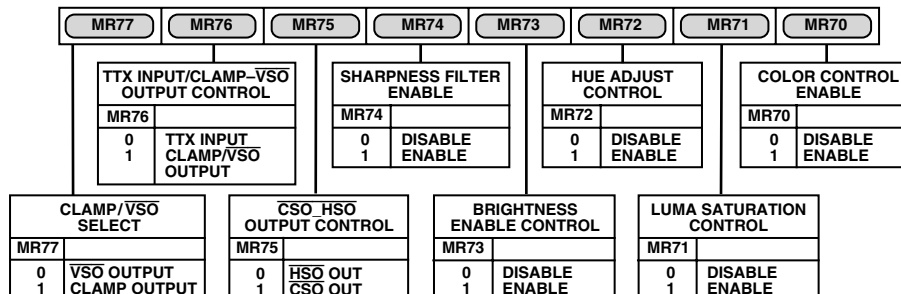

Figure 63. Mode Register 7, MR7

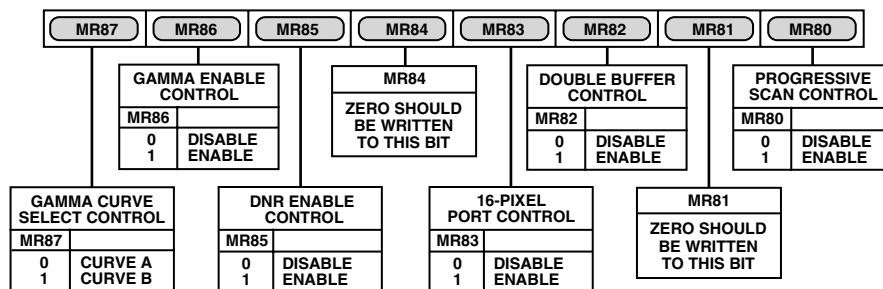

Figure 64. Mode Register 8, MR8

CLAMP/VSO Select (MR77)

This bit is used to select the functionality of Pin 62. Setting this bit to 1 selects CLAMP as the output signal. A 0 selects VSO as the output signal. Since this pin is also shared with the TTX functionality, TTX Input/CLAMP-VSO Output has to be set accordingly (MR76).

MODE REGISTER 8

MR8 (MR87-MR80)

(Address (SR4-SR0) = 08H)

Mode Register 8 is an 8-bit-wide register. Figure 64 shows the various operations under the control of Mode Register 8.

MR8 BIT DESCRIPTION

Progressive Scan Control (MR80)

This control enables the progressive scan inputs on pins Y(0)/P8-Y(7)/P15, Y(8)-Y(9), Cr(0)-Cr(9), Cb(0)-Cb(9). To enable this control MR80 has to be set to 1. It is assumed that the incoming Y data contains all necessary sync information.

Note: Simultaneous progressive scan input and 16-bit pixel input is not possible.

Reserved (MR81)

A 0 must be written to this bit.

Double Buffer Control (MR82)

Double Buffering can be enabled or disabled on the Contrast Control Register, U Scale Register, V Scale Register, Hue Adjust Control Register, Closed Captioning Register, Brightness Control Register, Gamma Curve Select Bit and the Macrovision Registers. Double Buffer is not available in Master Mode.

16-Bit Pixel Port (MR83)

This bit controls if the ADV7192 is operated in 8-bit or 16-bit mode. In 8-bit mode the input data will be set up on Pins P0-P7.

Reserved (MR84)

A Logic 0 must be written to this bit.

DNR Enable Control (MR85)

To enable the DNR process this bit has to be set to 1. If this bit is set to other DNR processing is bypassed. For further information on DNR controls see DNR Mode Control section.

Gamma Enable Control (MR86)

To enable the programmable gamma correction this bit has to be set to enabled (MR86 = 1). For further information on Gamma Correction controls see Gamma Correction Registers section.

Gamma Curve Select Control (MR87)

This bit selects which of the two programmable gamma curves is to be used. When setting MR87 to 0, the gamma correction curve

selected is Curve A. Otherwise, Curve B is selected. Each curve will have to be programmed by the user. For further information on Gamma Correction controls see Gamma Correction Registers section.

MODE REGISTER 9

MR9 (MR97-MR90)

(Address (SR4-SR0) = 09H)

Mode Register 9 is an 8-bit-wide register. Figure 66 shows the various operations under the control of Mode Register 9.

MR9 BIT DESCRIPTION

Undershoot Limiter (MR90-MR91)

This control ensures that no luma video data will go below a programmable level. This prevents any synchronization problems due to luma signals going below the blanking level. Available limit levels are -1.5 IRE, -6 IRE, -11 IRE. Note that this facility is only available in 4x Oversampling mode (MR16 = 1). When the device is operated in 2x Oversampling mode (MR16 = 0) or RGB output without RGB sync are selected, the minimum luma level is set in Timing Register 0, TR06 (Min Luma Control).

Black Burst Y DAC (MR92)

It is possible to output a Black Burst signal from the DAC which is selected to be the Luma DAC (MR22, MR21, MR20). This signal can be useful for locking two video sources together using professional video equipment. See also Black Burst Output section.

Black Burst Luma (MR93)

It is possible to output a Black Burst signal from the DAC which is selected to be the Y-DAC (MR22, MR21, MR20). This signal can be useful for locking two video sources together using professional video equipment. See also Black Burst Output section.

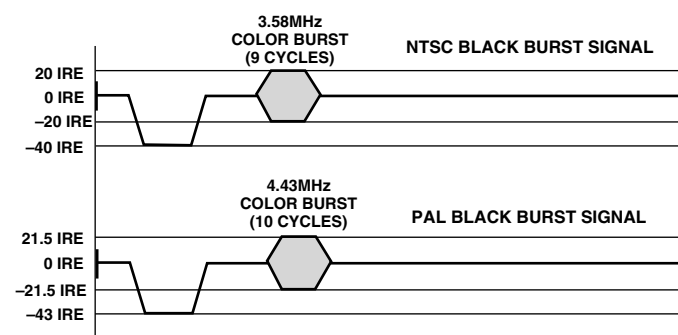

Figure 65. Black Burst Signals for PAL and NTSC Standards

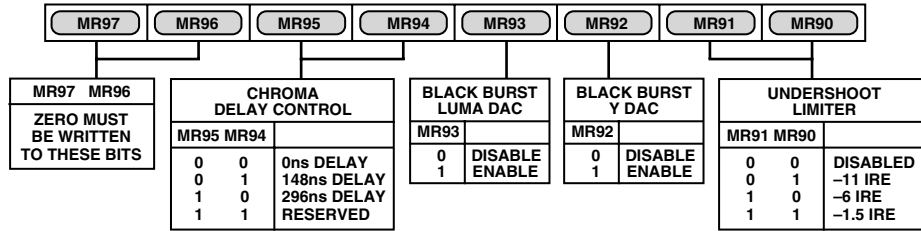

Figure 66. Mode Register 9 (MR9)

Chroma Delay Control (MR94–MR95)

The Chroma signal can be delayed by up to 8 clock cycles at 27 MHz using MR94–95. For further information see also Chroma/Luma Delay Section.

TIMING REGISTER 0 (TR07–TR00)

(Address (SR4–SR0) = 0AH)

Figure 67 shows the various operations under the control of Timing Register 0. This register can be read from as well as written to.

TR0 BIT DESCRIPTION

Master/Slave Control (TR00)

This bit controls whether the ADV7192 is in master or slave mode.

Timing Mode Selection (TR01–TR02)

These bits control the timing mode of the ADV7192. These modes are described in more detail in the Video Timing Description section of the data sheet.

BLANK Input Control (TR03)

This bit controls whether the $\overline{\text{BLANK}}$ input is used to accept blank signals or whether blank signals are internally generated.

Note: When this input pin is tied high (to 5 V), the input is disabled regardless of the register setting. It, therefore, should be tied low (to Ground) to allow control over the I²C register.

Luma Delay (TR04–TR05)

The luma signal can be delayed by up to 222 ns (or six clock cycles at 27 MHz) using TR04–TR05. For further information see Chroma/Luma Delay section.

Min Luminance Value (TR06)

This bit is used to control the minimum luma output value by the ADV7192 in 2× Oversampling mode and 4× Oversampling mode. When this bit is set to a Logic 1, the luma is limited to 7IRE below the blank level. When this bit is set to (0), the luma value can be as low as the sync bottom level.

Timing Register Reset (TR07)

Toggling TR07 from low to high and low again resets the internal timing counters. This bit should be toggled after power-up, reset or changing to a new timing mode.

TIMING REGISTER 1 (TR17–TR10)

(Address (SR4–SR0) = 0BH)

Timing Register 1 is a 8-bit-wide register.

Figure 68 shows the various operations under the control of Timing Register 1. This register can be read from as well written to. This register can be used to adjust the width and position of the master mode timing signals.

TR1 BIT DESCRIPTION

$\overline{\text{HSYNC}}$ Width (TR10–TR11)

These bits adjust the $\overline{\text{HSYNC}}$ pulsewidth.

T_{PCLK} = one clock cycle at 27 MHz.

$\overline{\text{HSYNC}}$ to $\overline{\text{VSYNC}}$ Delay (TR13–TR12)

These bits adjust the position of the $\overline{\text{HSYNC}}$ output relative to the $\overline{\text{VSYNC}}$ output.

T_{PCLK} = one clock cycle at 27 MHz.

$\overline{\text{HSYNC}}$ to $\overline{\text{VSYNC}}$ Rising Edge Delay (TR14–TR15)

When the ADV7192 is in Timing Mode 1, these bits adjust the position of the $\overline{\text{HSYNC}}$ output relative to the $\overline{\text{VSYNC}}$ output rising edge.

T_{PCLK} = one clock cycle at 27 MHz.

$\overline{\text{VSYNC}}$ Width (TR14–TR15)

When the ADV7192 is configured in Timing Mode 2, these bits adjust the $\overline{\text{VSYNC}}$ pulsewidth.

T_{PCLK} = one clock cycle at 27 MHz.

$\overline{\text{HSYNC}}$ to Pixel Data Adjust (TR16–TR17)

This enables the $\overline{\text{HSYNC}}$ to be adjusted with respect to the pixel data. This allows the Cr and Cb components to be swapped.

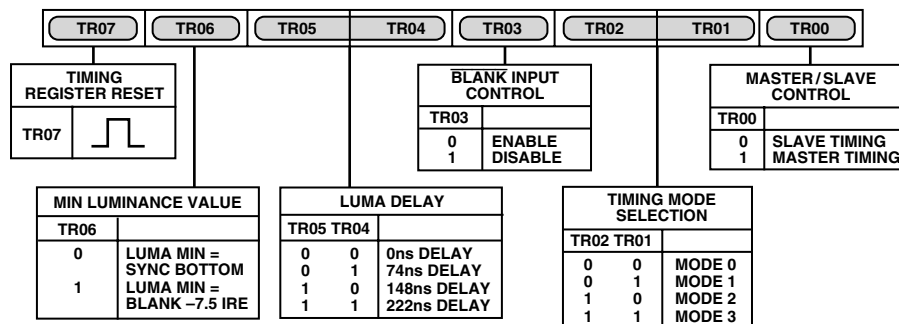

Figure 67. Timing Register 0

TR17		TR16		TR15		TR14		TR13		TR12		TR11		TR10	
HSYNC TO PIXEL DATA ADJUST				HSYNC TO VSYNC RISING EDGE DELAY (MODE 1 ONLY)				HSYNC TO VSYNC DELAY				HSYNC WIDTH			
TR17	TR16			TR15	TR14			TR13	TR12	T _B			TR11	TR10	T _A
0	0	0 × T _{PCLK}		×	0	T _B		0	0	0 × T _{PCLK}	0		0	1 × T _{PCLK}	
0	1	1 × T _{PCLK}		×	1	T _B + 32μs		0	1	4 × T _{PCLK}	0		1	4 × T _{PCLK}	
1	0	2 × T _{PCLK}						1	0	8 × T _{PCLK}	1		0	16 × T _{PCLK}	
1	1	3 × T _{PCLK}						1	1	18 × T _{PCLK}	1		1	128 × T _{PCLK}	
VSYNC WIDTH (MODE 2 ONLY)															
TR15		TR14													
0	0	1 × T _{PCLK}													
0	1	4 × T _{PCLK}													
1	0	16 × T _{PCLK}													
1	1	128 × T _{PCLK}													

TIMING MODE 1 (MASTER/PAL)

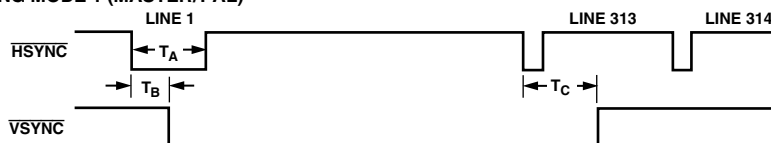

Figure 68. Timing Register 1

This adjustment is available in both master and slave timing modes.

T_{PCLK} = one clock cycle at 27 MHz.

SUBCARRIER FREQUENCY REGISTERS 3-0 (FSC31-FSC0) (Address (SR4-SR0) = 0CH-0FH)

These 8-bit-wide registers are used to set up the Subcarrier Frequency. The value of these registers are calculated by using the following equation:

$$\text{Subcarrier Frequency Register} = \frac{(2^{32} - 1) \times f_{SCF}}{f_{CLK}}$$

Example: NTSC Mode, f_{CLK} = 27 MHz, f_{SCF} = 3.5795454 MHz

$$\text{Subcarrier Frequency Value} = \frac{(2^{32} - 1) \times 3.5795454 \times 10^6}{27 \times 10^6}$$

Subcarrier Register Value = 21F07C16 Hex

Figure 69 shows how the frequency is set up by the four registers.

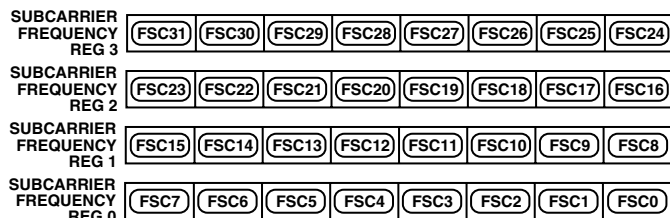

Figure 69. Subcarrier Frequency Registers

SUBCARRIER PHASE REGISTER (FPH7-FPH0) (Address (SR4-SR0) = 10H)

This 8-bit-wide register is used to set up the Subcarrier Phase. Each bit represents 1.41°. For normal operation this register is set to 00Hex.



Figure 70. Subcarrier Phase Register

CLOSED CAPTIONING EVEN FIELD DATA REGISTER 1-0 (CCD15-CCD0) (Address (SR4-SR0) = 11-12H)

These 8-bit-wide registers are used to set up the closed captioning extended data bytes on Even Fields. Figure 71 shows how the high and low bytes are set up in the registers.

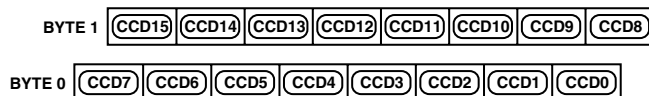

Figure 71. Closed Captioning Extended Data Register

CLOSED CAPTIONING ODD FIELD DATA REGISTER 1-0 (CED15-CED0) (Subaddress (SR4-SR0) = 13-14H)

These 8-bit-wide registers are used to set up the closed captioning data bytes on Odd Fields. Figure 72 shows how the high and low bytes are set up in the registers.

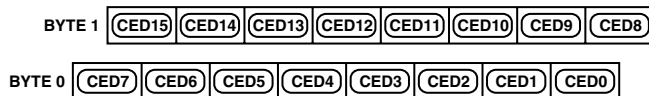

Figure 72. Closed Captioning Data Register

NTSC PEDESTAL/PAL TELETEXT CONTROL REGISTERS 3-0 (PCE15-0, PCO15-0)/(TXE15-0, TXO15-0) (Subaddress (SR4-SR0) = 15-18H)

These 8-bit-wide registers are used to enable the NTSC pedestal/PAL Teletext on a line-by-line basis in the vertical blanking interval for both odd and even fields. Figures 73 and 74 show the four control registers. A Logic 1 in any of the bits of these

ADV7192

registers has the effect of turning the Pedestal OFF on the equivalent line when used in NTSC. A Logic 1 in any of the bits of these registers has the effect of turning Teletext ON on the equivalent line when used in PAL.

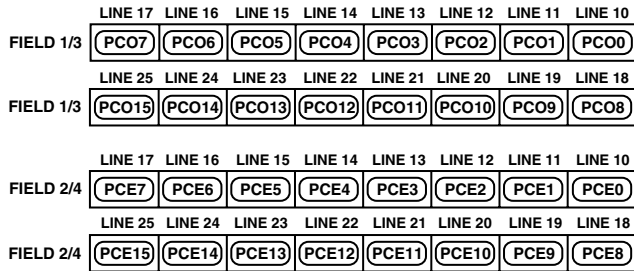

Figure 73. Pedestal Control Registers

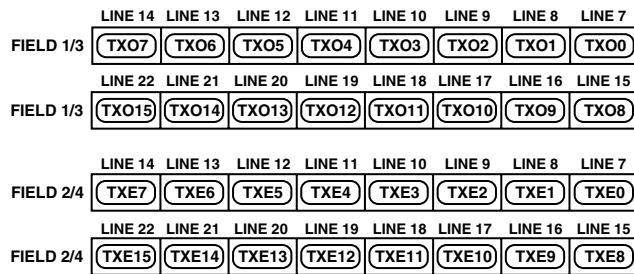

Figure 74. Teletext Control Registers

TELETEXT REQUEST CONTROL REGISTER TC07 (TC07–TC00)

(Address (SR4–SR0) = 1CH)

Teletext Control Register is an 8-bit-wide register. See Figure 75.

TTXREQ Falling Edge Control (TC00–TC03)

These bits control the position of the falling edge of TTXREQ. It can be programmed from zero clock cycles to a maximum of 15 clock cycles. This controls the active window for Teletext data. Increasing this value reduces the amount of Teletext bits below the default of 360. If Bits TC00–TC03 are 00Hex when Bits TC04–TC07 are changed then the falling edge of TTXREQ will track that of the rising edge (i.e., the time between the falling and rising edge remains constant).

PCLK = clock cycle at 27 MHz.

TTXREQ Rising Edge Control (TC04–TC07)

These bits control the position of the rising edge of TTXREQ. It can be programmed from zero clock cycles to a maximum of 15 clock cycles.

PCLK = clock cycle at 27 MHz.

TC07	TC06	TC05	TC04	TC03	TC02	TC01	TC00
TTXREQ RISING EDGE CONTROL				TTXREQ FALLING EDGE CONTROL			
TC07	TC06	TC05	TC04	TC03	TC02	TC01	TC00
0	0	0	0	0	0	0	0
0	0	0	1	1	1	1	1
"	"	"	"	"	"	"	"
1	1	1	0	14	14	14	14
1	1	1	1	15	15	15	15

Figure 75. Teletext Control Register

CGMS_WSS REGISTER 0 C/W0 (C/W07–C/W00)

(Address (SR4–SR0) = 19H)

CGMS_WSS register 0 is an 8-bit-wide register. Figure 76 shows the operations under control of this register.

C/W0 BIT DESCRIPTION

CGMS Data Bits (C/W00–C/W03)

These four data bits are the final four bits of CGMS data output stream. Note it is CGMS data ONLY in these bit positions, i.e., WSS data does not share this location.

CGMS CRC Check Control (C/W04)

When this bit is enabled (1), the last six bits of the CGMS data, i.e., the CRC check sequence, is internally calculated by the ADV7192. If this bit is disabled (0) the CRC values in the register are output to the CGMS data stream.

CGMS Odd Field Control (C/W05)

When this bit is set (1), CGMS is enabled for odd fields. Note this is only valid in NTSC mode.

CGMS Even Field Control (C/W06)

When this bit is set (1), CGMS is enabled for even fields. Note this is only valid in NTSC mode.

WSS Control (C/W07)

When this bit is set (1), wide screen signalling is enabled. Note this is only valid in PAL mode.

CGMS_WSS REGISTER 1 C/W1 (C/W17–C/W10)

(Address (SR4–SR0) = 1AH)

CGMS_WSS register 1 is an 8-bit-wide register. Figure 77 shows the operations under control of this register.

C/W1 BIT DESCRIPTION

CGMS/WSS Data (C/W10–C/W15)

These bit locations are shared by CGMS data and WSS data. In NTSC mode these bits are CGMS data. In PAL mode these bits are WSS data.

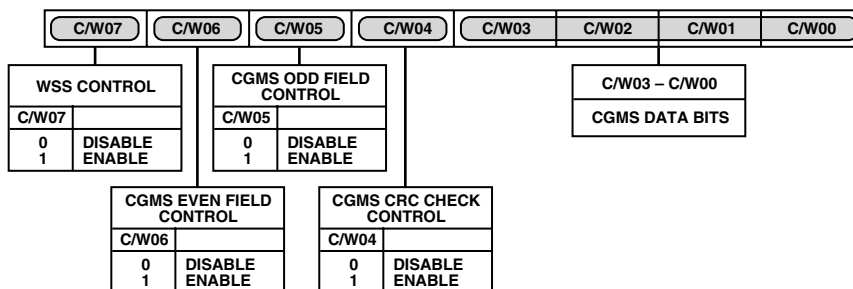

Figure 76. CGMS_WSS Register 0

CGMS Data (C/W16–C/W17)

These bits are CGMS data bits only.

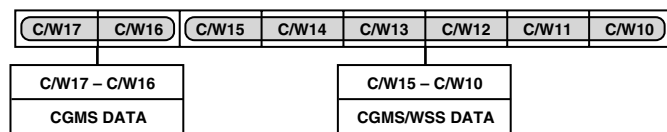

Figure 77. CGMS_WSS Register 1

CGMS_WSS REGISTER 2

C/W1 (C/W27–C/W20)

(Address (SR4–SR0) = 1BH)

CGMS_WSS Register 2 is an 8-bit-wide register. Figure 78 shows the operations under control of this register.

C/W2 BIT DESCRIPTION

CGMS/WSS Data (C/W20–C/W27)

These bit locations are shared by CGMS data and WSS data. In NTSC mode these bits are CGMS data. In PAL mode these bits are WSS data.

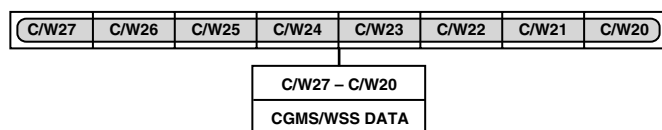

Figure 78. CGMS_WSS Register 2

CONTRAST CONTROL REGISTER (CC00–CC07)

(Address (SR4–SR0) = 1DH)

The contrast control register is an 8-bit-wide register used to scale the Y output levels. Figure 79 shows the operation under control of this register.

Y Scale Value (CC00–CC07)

These eight bits represent the value required to scale the Y pixel data from 0.0 to 1.5 of its initial level. The value of these eight bits is calculated using the following equation:

$$Y \text{ Scale Value} = \text{Scale Factor} \times 128$$

Example:

Scale Factor = 1.18

Y Scale Value = $1.18 \times 128 = 151.04$

Y Scale Value = 151 (rounded to the nearest integer)

Y Scale Value = 10010111_b

Y Scale Value = 97_h

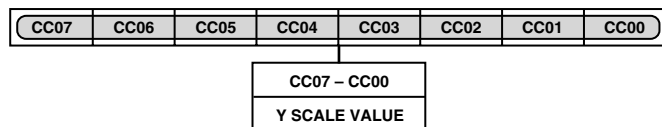

Figure 79. Contrast Control Register

COLOR CONTROL REGISTERS 1–2 (CC1–CC2)

(Address (SR4–SR0) = 1EH–1FH)

The color control registers are 8-bit-wide registers used to scale the U and V output levels. Figure 75 shows the operations under control of these registers.

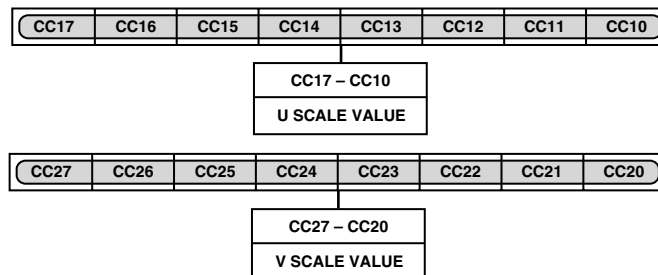

Figure 80. Color Control Registers

CC1 BIT DESCRIPTION

U Scale Value (CC10–CC17)

These eight bits represent the value required to scale the U level from 0.0 to 2.0 of its initial level. The value of these eight bits is calculated using the following equation:

$$U \text{ Scale Value} = \text{Scale Factor} \times 128$$

Example:

Scale Factor = 1.18

U Scale Value = $1.18 \times 128 = 151.04$

U Scale Value = 151 (rounded to the nearest integer)

U Scale Value = 10010111_b

U Scale Value = 97_h

CC2 BIT DESCRIPTION

V Scale Value (CC20–CC27)

These eight bits represent the value required to scale the V pixel data from 0.0 to 2.0 of its initial level. The value of these eight bits is calculated using the following equation:

$$V \text{ Scale Value} = \text{Scale Factor} \times 128$$

Example:

Scale Factor = 1.18

V Scale Value = $1.18 \times 128 = 151.04$

V Scale Value = 151 (rounded to the nearest integer)

V Scale Value = 10010111_b

V Scale Value = 97_h

ADV7192

HUE ADJUST CONTROL REGISTER (HCR)

(Address (SR5–SR0) = 20H)

The hue control register is an 8-bit-wide register used to adjust the hue on the composite and chroma outputs. Figure 81 shows the operation under control of this register.

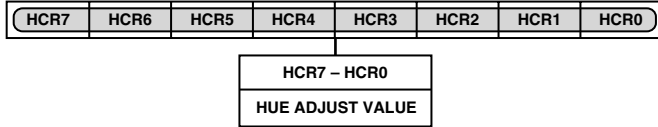

Figure 81. Hue Control Register

HCR BIT DESCRIPTION

Hue Adjust Value (HCR0–HCR7)

These eight bits represent the value required to vary the hue of the video data, i.e., the variance in phase of the subcarrier during active video with respect to the phase of the subcarrier during the colorburst. The ADV7192 provides a range of $\pm 22.5^\circ$ increments of 0.17578125° . For normal operation (zero adjustment), this register is set to 80Hex. FFHex and 00Hex represent the upper and lower limit (respectively) of adjustment attainable.

$Hue\ Adjust\ [^\circ] = 0.17578125^\circ \times (HCR_d - 128)$; for positive Hue Adjust Value

Example:

To adjust the hue by 4° write 97_h to the Hue Adjust Control Register:

$$(4/0.17578125) + 128 = 151_d^* = 97_h$$

To adjust the hue by (-4°) write 69_h to the Hue Adjust Control Register:

$$(-4/0.17578125) + 128 = 105_d^* = 69_h$$

*Rounded to the nearest integer.

EXAMPLE

1. Standard: NTSC with Pedestal. To add 20 IRE brightness level write 28_h into the Brightness Control Register:

$$[Brightness\ Control\ Register\ Value]_h = [IRE\ Value \times 2.015631]_h = [20 \times 2.015631]_h = [40.31262]_h = 28_h$$

2. Standard: PAL. To add -7 IRE brightness level write 72_h into the Brightness Control Register:

$$[|IRE\ Value| \times 2.015631] = [7 \times 2.015631] = [14.109417] = 0001110_b$$

$$[0001110] \text{ into two's complement} = 1110010_b = 72_h$$

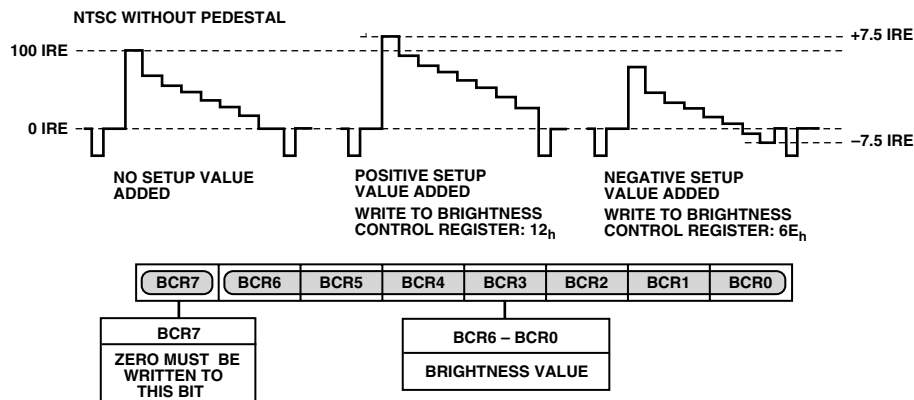

Figure 82. Brightness Control Register

BRIGHTNESS CONTROL REGISTER (BCR)

(Address (SR5–SR0) = 21H)

The brightness control register is an 8-bit-wide register which allows brightness control. Figure 82 shows the operation under control of this register.

BCR BIT DESCRIPTION

Brightness Value (BCR0–BCR6)

Seven bits of this 8-bit-wide register are used to control the brightness level. The brightness is controlled by adding a programmable setup level onto the scaled Y data. This brightness level can be a positive or negative value.

The programmable brightness levels in NTSC, without pedestal, and PAL are max 15 IRE and min -7.5 IRE, in NTSC pedestal max 22.5 IRE and min 0 IRE.

Table IV. Brightness Control Register Value

Setup Level in NTSC with Pedestal	Setup Level in NTSC No Pedestal	Setup Level in PAL	Brightness Control Register Value
22.5 IRE	15 IRE	15 IRE	$1E_h$
15 IRE	7.5 IRE	7.5 IRE	$0F_h$
7.5 IRE	0 IRE	0 IRE	00_h
0 IRE	-7.5 IRE	-7.5 IRE	71_h

NOTE

Values in the range from $3F_h$ to 44_h might result in an invalid output signal.

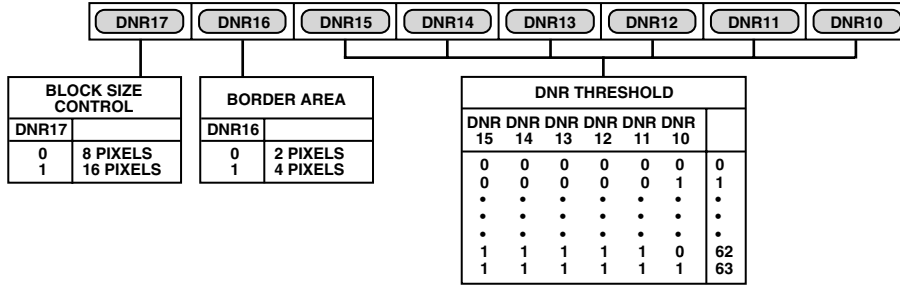

Figure 87. DNR Register 1

DNR2 BIT DESCRIPTION

DNR Input Select (DNR20–DNR22)

Three bits are assigned to select the filter which is applied to the incoming Y data. The signal which lies in the passband of the selected filter is the signal which will be DNR processed. Figure 88 shows the filter responses selectable with this control.

DNR Mode Control (DNR23)

This bit controls the DNR mode selected. A Logic 0 selects DNR mode, a Logic 1 selects DNR Sharpness mode.

DNR works on the principle of defining low amplitude, high-frequency signals as probable noise and subtracting this noise from the original signal.

In DNR mode, it is possible to subtract a fraction of the signal which lies below the set threshold, assumed to be noise, from the original signal. The threshold is set in DNR Register 1.

When DNR Sharpness mode is enabled it is possible to add a fraction of the signal which lies above the set threshold to the original signal, since this data is assumed to be valid data and not noise. The overall effect being that the signal will be boosted (similar to using Extended SSAF Filter).

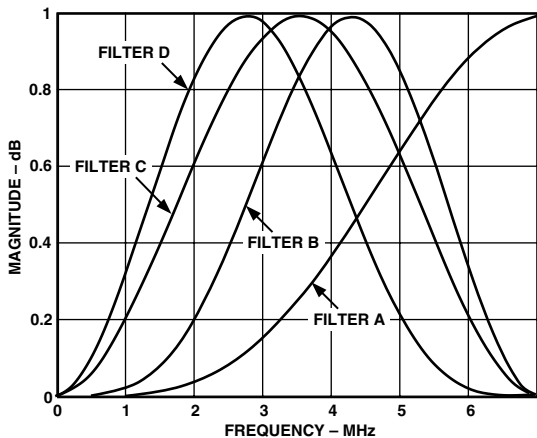

Figure 88. Filter Response of Filters Selectable

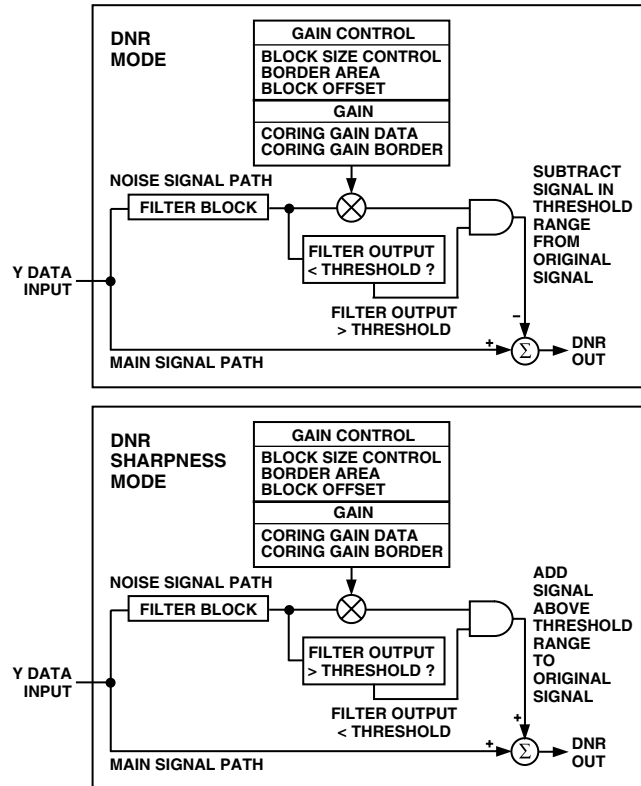

Figure 89. Block Diagram for DNR Mode and DNR Sharpness Mode

Block Offset (DNR24–DNR27)

Four bits are assigned to this control which allows a shift of the data block of 15 pixels maximum. Consider the coring gain positions fixed. The block offset shifts the data in steps of one pixel such that the border coring gain factors can be applied at the same position regardless of variations in input timing of the data.

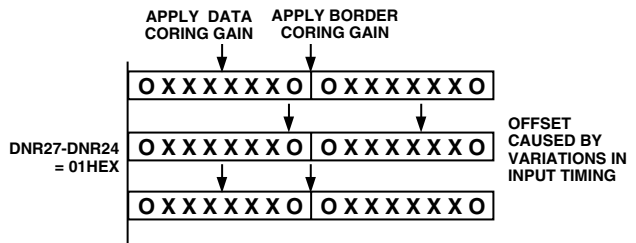

Figure 90. DNR27–DNR24 Block Offset Control

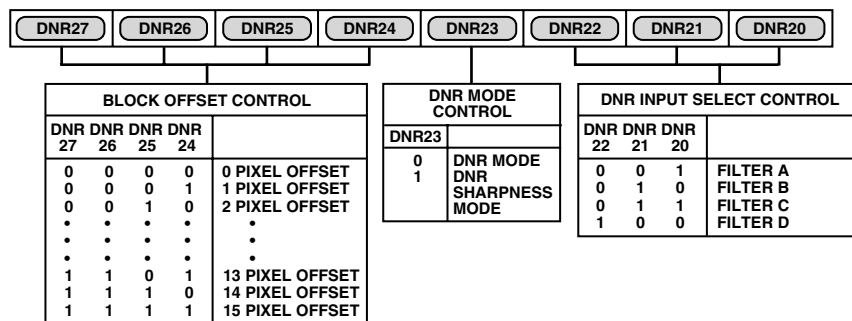

Figure 91. DNR Register 2

GAMMA CORRECTION REGISTERS 0–13 (GAMMA CORRECTION 0–13)

(Address (SR5–SR0) = 26H–32H)

The Gamma Correction Registers are fourteen 8-bit wide register. They are used to program the gamma correction Curves A and B.

Generally gamma correction is applied to compensate for the nonlinear relationship between signal input and brightness level output (as perceived on the CRT). It can also be applied whenever nonlinear processing is used.

Gamma correction uses the function:

$$Signal_{OUT} = (Signal_{IN})^\gamma$$

where

$$\gamma = \text{gamma power factor}$$

Gamma correction is performed on the luma data only. The user has the choice to use two different curves, Curve A or Curve B. At any one time only one of these curves can be used.

The response of the curve is programmed at seven predefined locations. In changing the values at these locations the gamma curve can be modified. Between these points linear interpolation is used to generate intermediate values. Considering the curve to have a total length of 256 points, the seven locations are at: 32, 64, 96, 128, 160, 192, and 224.

Location 0, 16, 240 and 255 are fixed and can not be changed.

For the length of 16 to 240 the gamma correction curve has to be calculated as below:

$$y = x^\gamma$$

where

y = gamma corrected output

x = linear input signal

γ = gamma power factor

To program the gamma correction registers, the seven values for y have to be calculated using the following formula:

$$y_n = [x_{(n-16)} / (240-16)]^\gamma \times (240-16) + 16$$

where

$x_{(n-16)}$ = Value for x along x-axis at points n = 32, 64, 96, 128, 160, 192, or 224

y_n = Value for y along the y-axis, which has to be written into the gamma correction register

Example:

$$y_{32} = [(16/224)^{0.5} \times 224] + 16 = 76^*$$

$$y_{64} = [(48/224)^{0.5} \times 224] + 16 = 120^*$$

$$y_{96} = [(80/224)^{0.5} \times 224] + 16 = 150^*$$

$$y_{128} = [(112/224)^{0.5} \times 224] + 16 = 174^*$$

*Rounded to the nearest integer.

The above will result in a gamma curve shown below, assuming a ramp signal as an input.

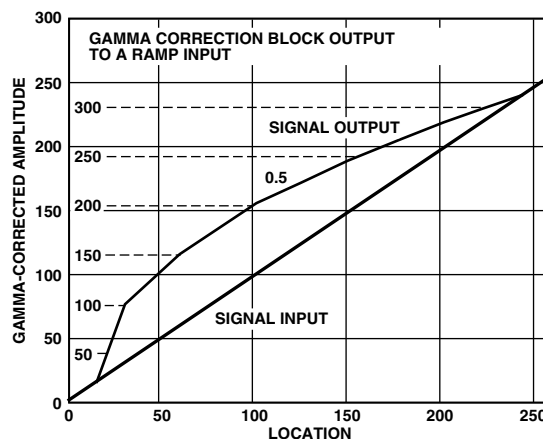

Figure 92. Signal Input (Ramp) and Signal Output for Gamma 0.5

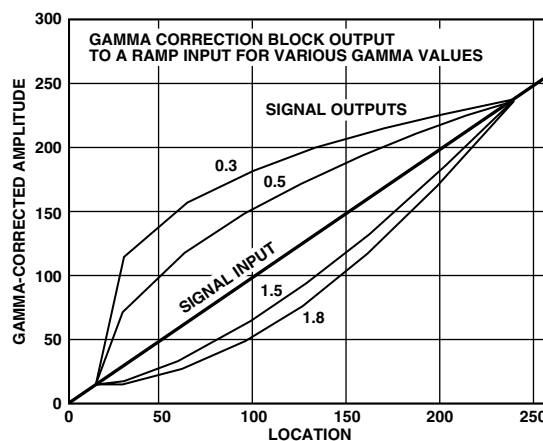

Figure 93. Signal Input (Ramp) and Selectable Gamma Output Curves

The gamma curves shown above are examples only, any user defined curve is acceptable in the range of 16–240.

ADV7192

BRIGHTNESS DETECT REGISTER

(Address (SR5–SR0) = 34H)

The Brightness Detect Register is an 8-bit-wide register used only to read back data in order to monitor the brightness/darkness of the incoming video data on a field-by-field basis. The brightness information is read from the I²C and based on this information, the color controls or the gamma correction controls may be adjusted.

The luma data is monitored in the active video area only. The average brightness I²C register is updated on the falling edge of every VSYNC signal.

OUTPUT CLOCK REGISTER (OCR 9–0)

(Address (SR4–SR0) = 35H)

The Output Clock Register is an 8-bit-wide register. Figure 93 shows the various operations under the control of this register.

OCR BIT DESCRIPTION

Reserved (OCR00)

A Logic 0 must be written to this bit.

CLKOUT Pin Control (OCR01)

This bit enables the CLKOUT pin when set to 1 and, therefore, outputs a 54 MHz clock generated by the internal PLL. The PLL and 4× Oversampling have to be enabled for this control to take effect, (MR61 = 0; MR16 = 1).

Reserved (OCR02–03)

A Logic 0 must be written to this bit.

Reserved (OCR04–06)

A Logic 1 must be written to these bits.

Reserved (OCR07)

A Logic 0 must be written to this bit.

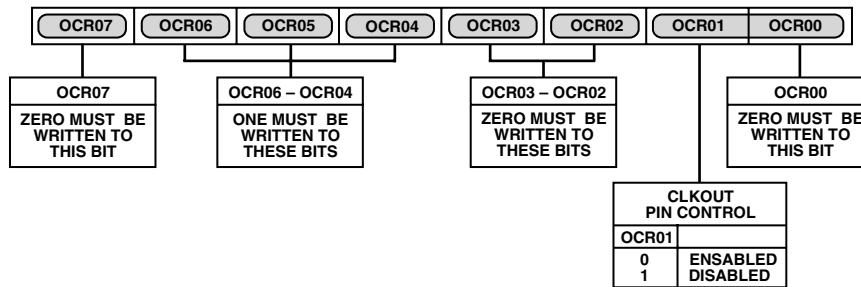

Figure 94. Output Clock Register

APPENDIX 1

BOARD DESIGN AND LAYOUT CONSIDERATIONS

The ADV7192 is a highly integrated circuit containing both precision analog and high-speed digital circuitry. It has been designed to minimize interference effects on the integrity of the analog circuitry by the high-speed digital circuitry. It is imperative that these same design and layout techniques be applied to the system level design such that high-speed, accurate performance is achieved. The Recommended Analog Circuit Layout shows the analog interface between the device and monitor.

The layout should be optimized for lowest noise on the ADV7192 power and ground lines by shielding the digital inputs and providing good decoupling. The lead length between groups of V_{AA} and GND pins should be minimized so as to minimize inductive ringing.

Ground Planes

The ground plane should encompass all ADV7192 ground pins, voltage reference circuitry, power supply bypass circuitry for the ADV7192, the analog output traces, and all the digital signal traces leading up to the ADV7192. This should be as substantial as possible to maximize heat spreading and power dissipation on the board.

Power Planes

The ADV7192 and any associated analog circuitry should have its own power plane, referred to as the analog power plane (V_{AA}). This power plane should be connected to the regular PCB power plane (V_{CC}) at a single point through a ferrite bead. This bead should be located within three inches of the ADV7192.

The metallization gap separating device power plane and board power plane should be as narrow as possible to minimize the obstruction to the flow of heat from the device into the general board.

The PCB power plane should provide power to all digital logic on the PC board, and the analog power plane should provide power to all ADV7192 power pins and voltage reference circuitry.

Plane-to-plane noise coupling can be reduced by ensuring that portions of the regular PCB power and ground planes do not overlay portions of the analog power plane, unless they can be arranged such that the plane-to-plane noise is common-mode.

Supply Decoupling

For optimum performance, bypass capacitors should be installed using the shortest leads possible, consistent with reliable operation, to reduce the lead inductance. Best performance is obtained with 0.1 μF ceramic capacitor decoupling. Each group of V_{AA}

pins on the ADV7192 must have at least one 0.1 μF decoupling capacitor to GND. These capacitors should be placed as close as possible to the device.

It is important to note that while the ADV7192 contains circuitry to reject power supply noise, this rejection decreases with frequency. If a high frequency switching power supply is used, the designer should pay close attention to reducing power supply noise and consider using a three-terminal voltage regulator for supplying power to the analog power plane.

Digital Signal Interconnect

The digital inputs to the ADV7192 should be isolated as much as possible from the analog outputs and other analog circuitry. Also, these input signals should not overlay the analog power plane.

Due to the high clock rates involved, long clock lines to the ADV7192 should be avoided to reduce noise pickup.

Any active termination resistors for the digital inputs should be connected to the regular PCB power plane (V_{CC}), and not the analog power plane.

Analog Signal Interconnect

The ADV7192 should be located as close as possible to the output connectors to minimize noise pickup and reflections due to impedance mismatch.

The video output signals should overlay the ground plane, and not the analog power plane, to maximize the high frequency power supply rejection.

Digital inputs, especially pixel data inputs and clocking signals should never overlay any of the analog signal circuitry and should be kept as far away as possible.

For best performance, the outputs should each have a 300 Ω load resistor connected to GND. These resistors should be placed as close as possible to the ADV7192 so as to minimize reflections.

The ADV7192 should have no inputs left floating. Any inputs that are not required should be tied to ground.

ADV7192

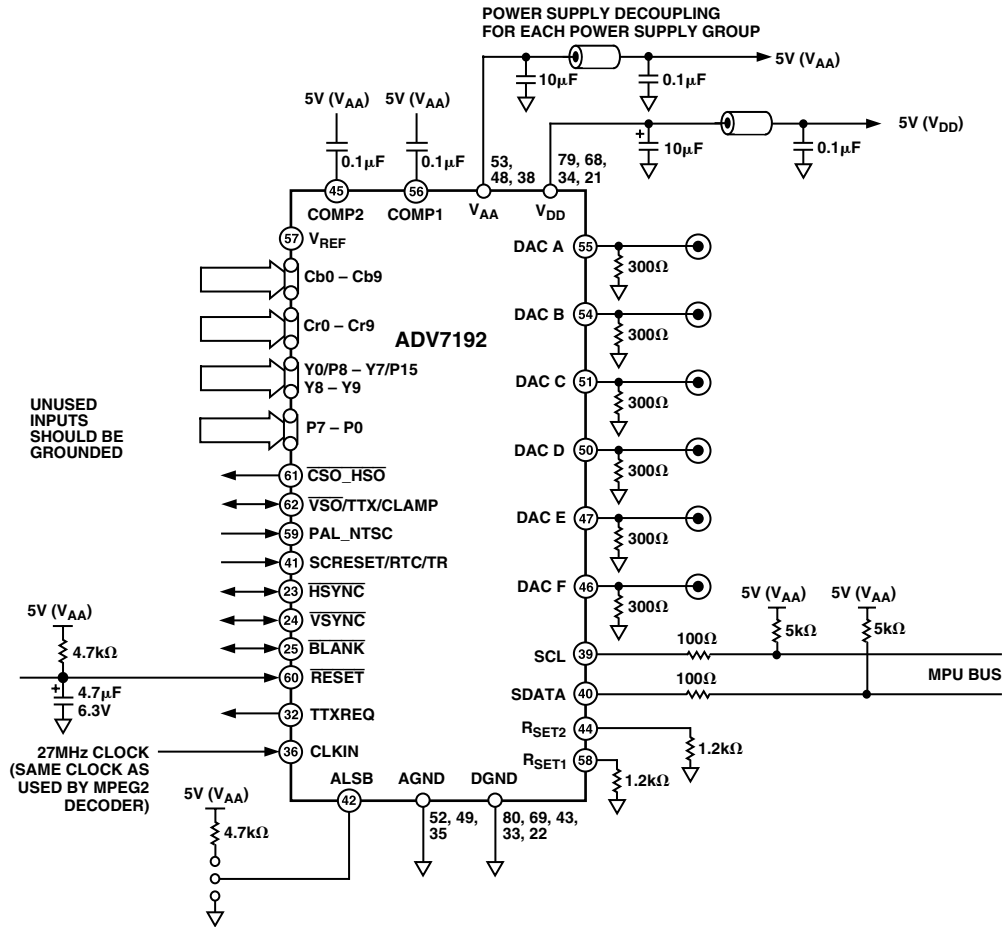

Figure 95. Recommended Analog Circuit Layout

APPENDIX 2
CLOSED CAPTIONING

The ADV7192 supports closed captioning conforming to the standard television synchronizing waveform for color transmission. Closed captioning is transmitted during the blanked active line time of Line 21 of the odd fields and Line 284 of even fields.

Closed captioning consists of a seven-cycle sinusoidal burst that is frequency and phase locked to the caption data. After the clock run-in signal, the blanking level is held for two data bits and is followed by a Logic Level 1 start bit. Sixteen bits of data follow the start bit. These consist of two eight-bit bytes, seven data bits, and one odd parity bit. The data for these bytes is stored in Closed Captioning Data Registers 0 and 1.

The ADV7192 also supports the extended closed captioning operation which is active during even fields and is encoded on Scan Line 284. The data for this operation is stored in Closed Captioning Extended Data Registers 0 and 1.

All clock run-in signals and timing to support Closed Captioning on Lines 21 and 284 are generated automatically by the ADV7192. All pixels inputs are ignored during Lines 21 and 284 if closed captioning is enabled.

FCC Code of Federal Regulations (CFR) 47 Section 15.119 and EIA608 describe the closed captioning information for Lines 21 and 284.

The ADV7192 uses a single buffering method. This means that the closed captioning buffer is only one byte deep, therefore, there will be no frame delay in outputting the closed captioning data unlike other two byte deep buffering systems. The data must be loaded one line before (Line 20 or Line 283) it is outputted on Line 21 and Line 284. A typical implementation of this method is to use \overline{VSYNC} to interrupt a microprocessor, which in turn will load the new data (two bytes) every field. If no new data is required for transmission, 0s must be inserted in both data registers, this is called NULLING. It is also important to load *control codes* all of which are double bytes on Line 21 or a TV will not recognize them. If there is a message like *Hello World* which has an odd number of characters, it is important to pad it out to even in order to get *end of caption 2-byte control code* to land in the same field.

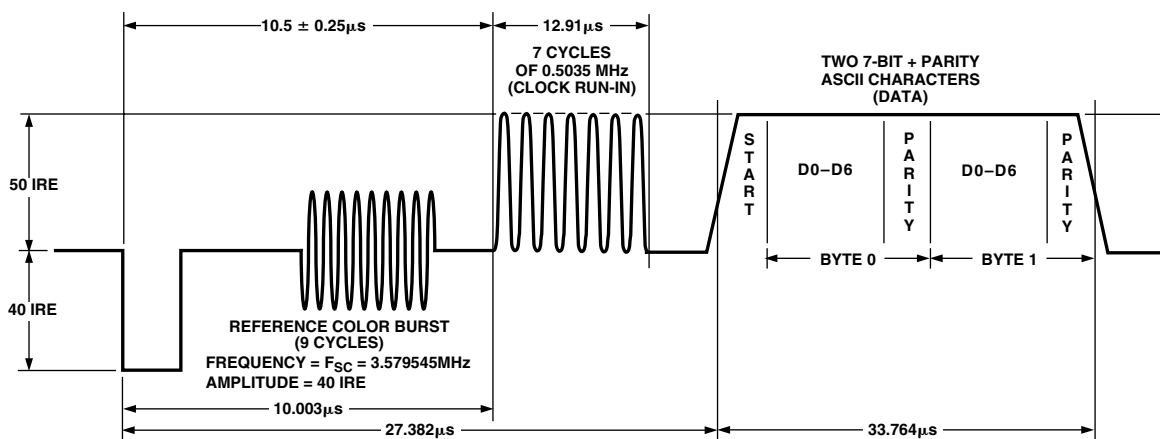

Figure 96. Closed Captioning Waveform (NTSC)

APPENDIX 3 COPY GENERATION MANAGEMENT SYSTEM (CGMS)

The ADV7192 supports Copy Generation Management System (CGMS) conforming to the standard. CGMS data is transmitted on Line 20 of the odd fields and Line 283 of even fields. Bits C/W05 and C/W06 control whether or not CGMS data is outputted on ODD and EVEN fields. CGMS data can only be transmitted when the ADV7192 is configured in NTSC mode. The CGMS data is 20 bits long, the function of each of these bits is as shown below. The CGMS data is preceded by a reference pulse of the same amplitude and duration as a CGMS bit, see Figure 96. These bits are outputted from the configuration registers in the following order: C/W00 = C16, C/W01 = C17, C/W02 = C18, C/W03 = C19, C/W10 = C8, C/W11 = C9, C/W12 = C10, C/W13 = C11, C/W14 = C12, C/W15 = C13, C/W16 = C14, C/W17 = C15, C/W20 = C0, C/W21 = C1, C/W22 = C2, C/W23 = C3, C/W24 = C4, C/W25 = C5, C/W26 = C6, C/W27 = C7. If the bit C/W04 is set to a Logic 1, the last six bits C19–C14 which comprise the 6-bit CRC check sequence are calculated automatically on the ADV7192 based on the lower 14 bits (C0–C13) of the data in the data registers and output with the remaining 14-bits to form the complete 20-bits of the CGMS data. The calculation of the CRC sequence is based on the polynomial $X^6 + X + 1$ with a preset value of 111111. If C/W04 is set to a Logic 0 then all 20-bits (C0–C19) are output directly from the CGMS registers (no CRC calculated, must be calculated by the user).

Function of CGMS Bits

Word 0 – 6 Bits
 Word 1 – 4 Bits
 Word 2 – 6 Bits
 CRC – 6 Bits CRC Polynomial = $X^6 + X + 1$ (Preset to 111111)

WORD 0		1	0
B1	Aspect Ratio	16:9	4:3
B2	Display Format	Letterbox	Normal
B3	Undefined		

WORD 0
 B4, B5, B6 Identification Information About Video and Other Signals (e.g., Audio)

WORD 1
 B7, B8, B9, B10 Identification Signal Incidental to Word 0

WORD 2
 B11, B12, B13, B14 Identification Signal and Information Incidental to Word 0

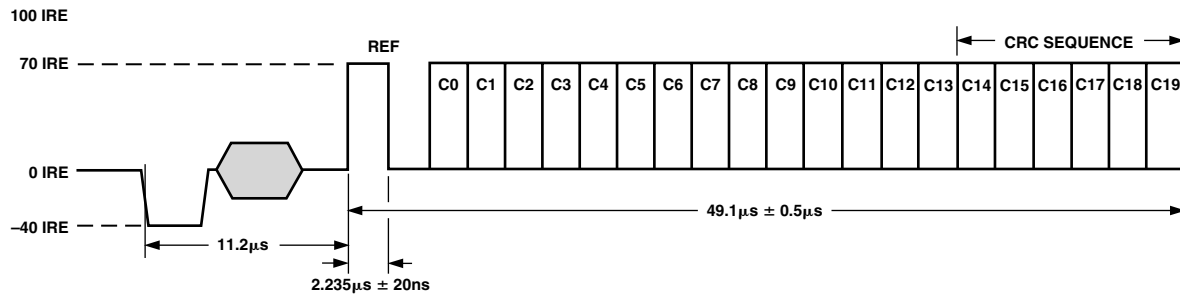

Figure 97. CGMS Waveform Diagram

APPENDIX 4
WIDE SCREEN SIGNALING

The ADV7192 supports Wide Screen Signaling (WSS) conforming to the standard. WSS data is transmitted on Line 23. WSS data can only be transmitted when the ADV7192 is configured in PAL mode. The WSS data is 14-bits long, the function of each of these bits is as shown below. The WSS data is preceded by a run-in sequence and a Start Code, see Figure 97. The bits are output from the configuration registers in the following order: C/W20 = W0, C/W21 = W1, C/W22 = W2, C/W23 = W3, C/W24 = W4, C/W25 = W5, C/W26 = W6, C/W27 = W7, C/W10 = W8, C/W11 = W9, C/W12 = W10, C/W13 = W11, C/W14 = W12, C/W15 = W13. If the bit C/W07 is set to a Logic 1, it enables the WSS data to be transmitted on Line 23. The latter portion of Line 23 (42.5 μ s from the falling edge of $\overline{\text{HSYNC}}$) is available for the insertion of video.

Function of CGMS Bits

Bit 0–Bit 2	Aspect Ratio/Format/Position		
Bit 3	Is Odd Parity Check of Bit 0–Bit 2		
B0, B1, B2, B3	Aspect Ratio	Format	Position
0 0 0 1	4:3	Full Format	Nonapplicable
1 0 0 0	14:9	Letterbox	Center
0 1 0 0	14:9	Letterbox	Top
1 1 0 1	16:9	Letterbox	Center
0 0 1 0	16:9	Letterbox	Top
1 0 1 1	>16:9	Letterbox	Center
0 1 1 1	14:9	Full Format	Center
1 1 1 0	16:9	Nonapplicable	Nonapplicable

B4	0	Camera Mode
	1	Film Mode
B5	0	Standard Coding
	1	Motion Adaptive Color Plus
B6	0	No Helper
	1	Modulated Helper
B7		RESERVED
B9	B10	
	0	No Open Subtitles
	1	0 Subtitles in Active Image Area
	0	1 Subtitles Out of Active Image Area
	1	1 RESERVED
B11	0	No Surround Sound Information
	1	Surround Sound Mode
B12		RESERVED
B13		RESERVED

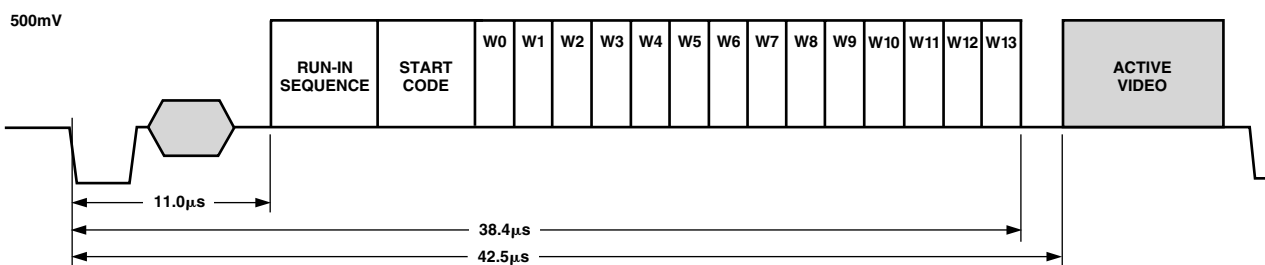

Figure 98. WSS Waveform Diagram

APPENDIX 5 TELETEXT INSERTION

Time, t_{PD} , is the time needed by the ADV7192 to interpolate input data on TTX and insert it onto the CVBS or Y outputs, such that it appears $t_{SYNXTOUT} = 10.2 \mu s$ after the leading edge of the horizontal signal. Time TTX_{DEL} is the pipeline delay time by the source that is gated by the TTREQ signal in order to deliver TTX data.

With the programmability that is offered with TTXREQ signal on the Rising/Falling edges, the TTX data is always inserted at the correct position of $10.2 \mu s$ after the leading edge of Horizontal Sync pulse, thus this enables a source interface with variable pipeline delays.

The width of the TTXREQ signal must always be maintained such that it allows the insertion of 360 (in order to comply with the Teletext Standard PAL-WST) teletext bits at a text data rate of 6.9375 Mbits/s, this is achieved by setting TC03–TC00 to 0. The insertion window is not open if the Teletext Enable bit (MR34) is set to 0.

Teletext Protocol

The relationship between the TTX bit clock (6.9375 MHz) and the system CLOCK (27 MHz) for 50 Hz is given as follows:

$$(27 \text{ MHz}/4) = 6.75 \text{ MHz}$$

$$(6.9375 \times 10^6 / 6.75 \times 10^6) = 1.027777$$

Thus 37 TTX bits correspond to 144 clocks (27 MHz), each bit has a width of almost four clock cycles. The ADV7192 uses an internal sequencer and variable phase interpolation filter to minimize the phase jitter and thus generate a bandlimited signal which can be output on the CVBS and Y outputs.

At the TTX input the bit duration scheme repeats after every 37 TTX bits or 144 clock cycles. The protocol requires that TTX Bits 10, 19, 28, 37 are carried by three clock cycles, all other bits by four clock cycles. After 37 TTX bits, the next bits with three clock cycles are Bits 47, 56, 65, and 74. This scheme holds for all following cycles of 37 TTX bits, until all 360 TTX bits are completed. All teletext lines are implemented in the same way. Individual control of teletext lines are controlled by Teletext Setup Registers.

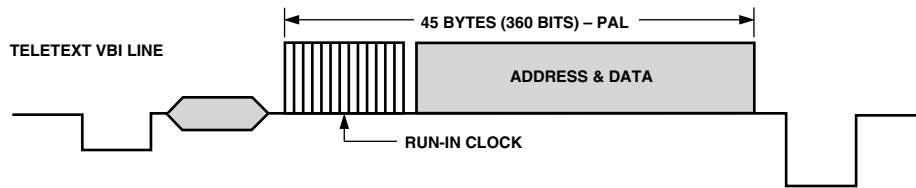

Figure 99. Teletext VBI Line

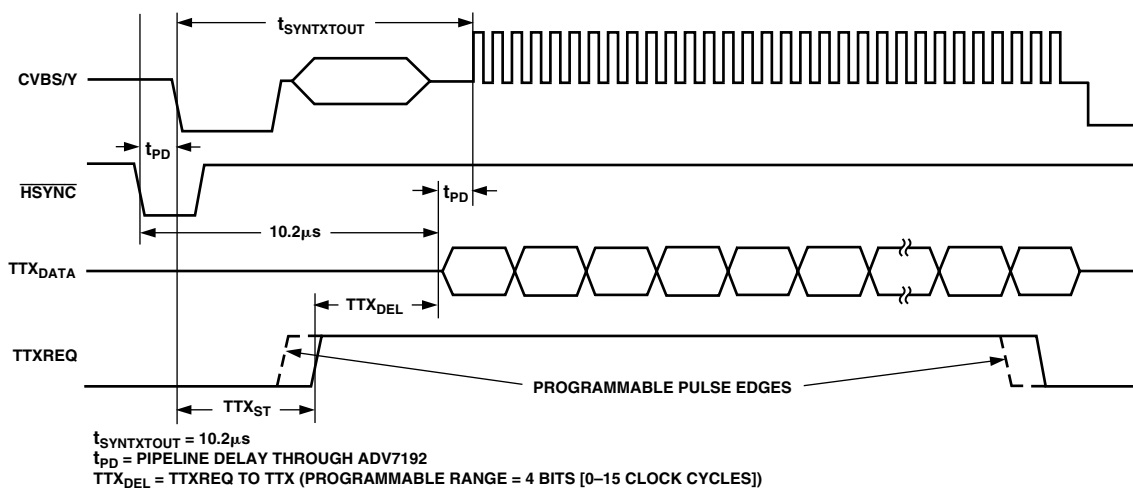

Figure 100. Teletext Functionality Diagram

APPENDIX 6

OPTIONAL OUTPUT FILTER

If an output filter is required for the CVBS, Y, UV, Chroma and RGB outputs of the ADV7192, the following filter in Figure 101 can be used in 2× Oversampling Mode. In 4× Oversampling Mode the filter in Figure 103 is recommended. The plot of the filter characteristics are shown in Figures 102 and 104. An output

filter is not required if the outputs of the ADV7192 are connected to most analog monitors or TVs, however, if the output signals are applied to a system where sampling is used, (e.g., Digital TVs) then a filter is required to prevent aliasing.

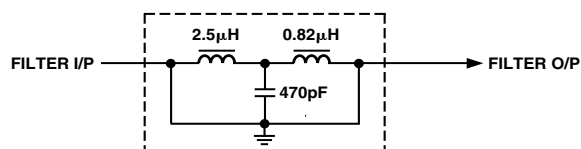

Figure 101. Output Filter for 2× Oversampling Mode

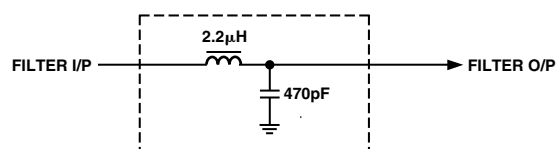

Figure 103. Output Filter for 4× Oversampling Mode

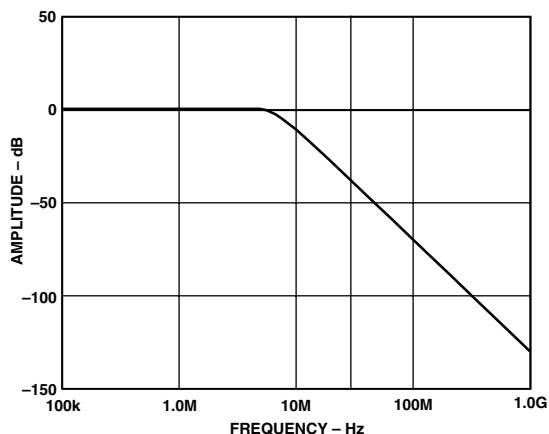

Figure 102. Output Filter Plot for 2× Oversampling Filter

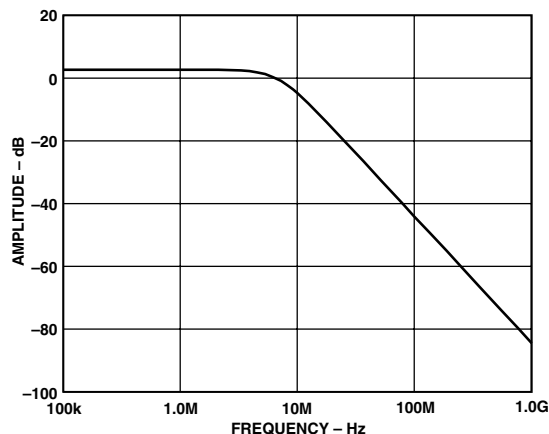

Figure 104. Output Filter Plot for 4× Oversampling Filter

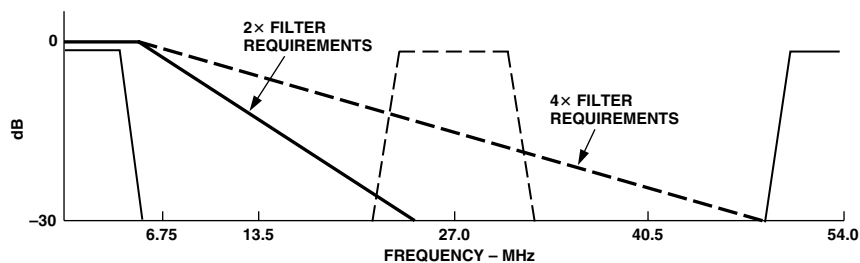

Figure 105. Output Filter Requirements in 4× Oversampling Mode

APPENDIX 7 DAC BUFFERING

External buffering is needed on the ADV7192 DAC outputs. The configuration in Figure 106 is recommended.

When calculating absolute output full-scale current and voltage use the following equations:

$$V_{OUT} = I_{OUT} \times R_{LOAD}$$

$$I_{OUT} = (V_{REF} \times K) / R_{SET}$$

$K = 4.2146$ constant, $V_{REF} = 1.235$ V

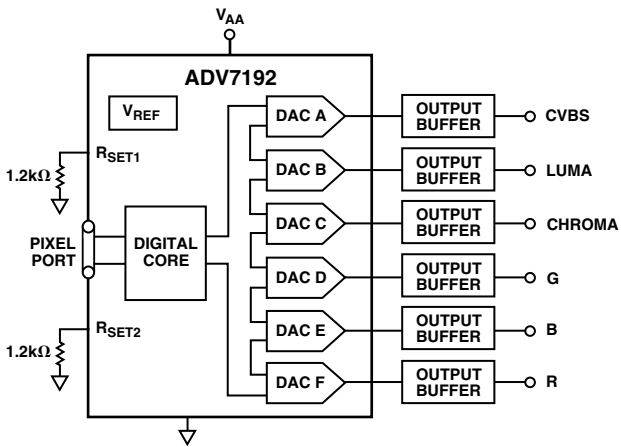

Figure 106. Output DAC Buffering Configuration

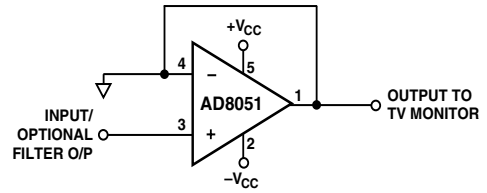

Figure 107. Recommended DAC Output Buffer Using an Op Amp

APPENDIX 8
RECOMMENDED REGISTER VALUES

The ADV7192 registers can be set depending on the user standard required. The following examples give the various register formats for several video standards.

NTSC (F_{SC} = 3.5795454 MHz)

Address	Data
00Hex	Mode Register 0
01Hex	Mode Register 1
02Hex	Mode Register 2
03Hex	Mode Register 3
04Hex	Mode Register 4
05Hex	Mode Register 5
06Hex	Mode Register 6
07Hex	Mode Register 7
08Hex	Mode Register 8
09Hex	Mode Register 9
0AHex	Timing Register 0
0BHex	Timing Register 1
0CHex	Subcarrier Frequency Register 0
0DHex	Subcarrier Frequency Register 1
0EHex	Subcarrier Frequency Register 2
0FHex	Subcarrier Frequency Register 3
10Hex	Subcarrier Phase Register
11Hex	Closed Captioning Ext Register 0
12Hex	Closed Captioning Ext Register 1
13Hex	Closed Captioning Register 0
14Hex	Closed Captioning Register 1
15Hex	Pedestal Control Register 0
16Hex	Pedestal Control Register 1
17Hex	Pedestal Control Register 2
18Hex	Pedestal Control Register 3
19Hex	CGMS_WSS Reg 0
1AHex	CGMS_WSS Reg 1
1BHex	CGMS_WSS Reg 2
1CHex	Teletext Control Register
1DHex	Contrast Control Register
1EHex	Color Control Register 1
1FHex	Color Control Register 2
20Hex	Hue Control Register
21Hex	Brightness Control Register
22Hex	Sharpness Response Register
23Hex	DNR 0
24Hex	DNR 1
25Hex	DNR 2
35Hex	Output Clock Register

PAL B, D, G, H, I (F_{SC} = 4.43361875 MHz)

Address	Data
00Hex	Mode Register 0
01Hex	Mode Register 1
02Hex	Mode Register 2
03Hex	Mode Register 3
04Hex	Mode Register 4
05Hex	Mode Register 5
06Hex	Mode Register 6
07Hex	Mode Register 7
08Hex	Mode Register 8
09Hex	Mode Register 9
0AHex	Timing Register 0
0BHex	Timing Register 1
0CHex	Subcarrier Frequency Register 0
0DHex	Subcarrier Frequency Register 1
0EHex	Subcarrier Frequency Register 2
0FHex	Subcarrier Frequency Register 3
10Hex	Subcarrier Phase Register
11Hex	Closed Captioning Ext Register 0
12Hex	Closed Captioning Ext Register 1
13Hex	Closed Captioning Register 0
14Hex	Closed Captioning Register 1
15Hex	Pedestal Control Register 0
16Hex	Pedestal Control Register 1
17Hex	Pedestal Control Register 2
18Hex	Pedestal Control Register 3
19Hex	CGMS_WSS Reg 0
1AHex	CGMS_WSS Reg 1
1BHex	CGMS_WSS Reg 2
1CHex	Teletext Control Register
1DHex	Contrast Control Register
1EHex	Color Control Register 1
1FHex	Color Control Register 2
20Hex	Hue Control Register
21Hex	Brightness Control Register
22Hex	Sharpness Response Register
23Hex	DNR0
24Hex	DNR1
25Hex	DNR2
35Hex	Output Clock Register

ADV7192

PAL N (F_{SC} = 4.43361875 MHz)

Address		Data
00Hex	Mode Register 0	13Hex
01Hex	Mode Register 1	3FHex
02Hex	Mode Register 2	62Hex
03Hex	Mode Register 3	00Hex
04Hex	Mode Register 4	00Hex
05Hex	Mode Register 5	00Hex
06Hex	Mode Register 6	00Hex
07Hex	Mode Register 7	00Hex
08Hex	Mode Register 8	04Hex
09Hex	Mode Register 9	00Hex
0AHex	Timing Register 0	08Hex
0BHex	Timing Register 1	00Hex
0CHex	Subcarrier Frequency Register 0	CBHex
0DHex	Subcarrier Frequency Register 1	8AHex
0EHex	Subcarrier Frequency Register 2	09Hex
0FHex	Subcarrier Frequency Register 3	2AHex
10Hex	Subcarrier Phase Register	00Hex
11Hex	Closed Captioning Ext Register 0	00Hex
12Hex	Closed Captioning Ext Register 1	00Hex
13Hex	Closed Captioning Register 0	00Hex
4Hex	Closed Captioning Register 1	00Hex
15Hex	Pedestal Control Register 0	00Hex
16Hex	Pedestal Control Register 1	00Hex
17Hex	Pedestal Control Register 2	00Hex
18Hex	Pedestal Control Register 3	00Hex
19Hex	CGMS_WSS Reg 0	00Hex
1AHex	CGMS_WSS Reg 1	00Hex
1BHex	CGMS_WSS Reg 2	00Hex
1CHex	Teletext Control Register	00Hex
DHex	Contrast Control Register	00Hex
1EHex	Color Control Register 1	00Hex
1FHex	Color Control Register 2	00Hex
20Hex	Hue Control Register	00Hex
21Hex	Brightness Control Register	00Hex
22Hex	Sharpness Response Register	00Hex
23Hex	DNR 0	44Hex
24Hex	DNR 1	20Hex
25Hex	DNR 2	00Hex
35Hex	Output Clock Register	70Hex

PAL 60 (F_{SC} = 4.43361875 MHz)

Address		Data
00Hex	Mode Register 0	12Hex
01Hex	Mode Register 1	3FHex
02Hex	Mode Register 2	62Hex
03Hex	Mode Register 3	00Hex
04Hex	Mode Register 4	00Hex
05Hex	Mode Register 5	00Hex
06Hex	Mode Register 6	00Hex
07Hex	Mode Register 7	00Hex
08Hex	Mode Register 8	04Hex
09Hex	Mode Register 9	00Hex
0AHex	Timing Register 0	08Hex
0BHex	Timing Register 1	00Hex
0CHex	Subcarrier Frequency Register 0	CBHex
0DHex	Subcarrier Frequency Register 1	8AHex
0EHex	Subcarrier Frequency Register 2	09Hex
0FHex	Subcarrier Frequency Register 3	2AHex
10Hex	Subcarrier Phase Register	00Hex
11Hex	Closed Captioning Ext Register 0	00Hex
12Hex	Closed Captioning Ext Register 1	00Hex
13Hex	Closed Captioning Register 0	00Hex
14Hex	Closed Captioning Register 1	00Hex
15Hex	Pedestal Control Register 0	00Hex
16Hex	Pedestal Control Register 1	00Hex
17Hex	Pedestal Control Register 2	00Hex
18Hex	Pedestal Control Register 3	00Hex
19Hex	CGMS_WSS Reg 0	00Hex
1AHex	CGMS_WSS Reg 1	00Hex
1BHex	CGMS_WSS Reg 2	00Hex
1CHex	Teletext Control Register	00Hex
1DHex	Contrast Control Register	00Hex
1EHex	Color Control Register 1	00Hex
1FHex	Color Control Register 2	00Hex
20Hex	Hue Control Register	00Hex
21Hex	Brightness Control Register	00Hex
22Hex	Sharpness Response Register	00Hex
23Hex	DNR 0	44Hex
24Hex	DNR 1	20Hex
25Hex	DNR 2	00Hex
35Hex	Output Clock Register	70Hex

PAL M (F_{SC} = 3.57561149 MHz)

Address		Data	Address		Data
00Hex	Mode Register 0	12Hex	13Hex	Closed Captioning Register 0	00Hex
01Hex	Mode Register 1	3FHex	14Hex	Closed Captioning Register 1	00Hex
02Hex	Mode Register 2	62Hex	15Hex	Pedestal Control Register 0	00Hex
03Hex	Mode Register 3	00Hex	16Hex	Pedestal Control Register 1	00Hex
04Hex	Mode Register 4	00Hex	17Hex	Pedestal Control Register 2	00Hex
05Hex	Mode Register 5	00Hex	18Hex	Pedestal Control Register 3	00Hex
06Hex	Mode Register 6	00Hex	19Hex	CGMS_WSS Reg 0	00Hex
07Hex	Mode Register 7	00Hex	1AHex	CGMS_WSS Reg 1	00Hex
08Hex	Mode Register 8	04Hex	1BHex	CGMS_WSS Reg 2	00Hex
09Hex	Mode Register 9	00Hex	1CHex	Teletext Control Register	00Hex
0AHex	Timing Register 0	08Hex	1DHex	Contrast Control Register	00Hex
0BHex	Timing Register 1	00Hex	1EHex	Color Control Register 1	00Hex
0CHex	Subcarrier Frequency Register 0	A3Hex	1FHex	Color Control Register 2	00Hex
0DHex	Subcarrier Frequency Register 1	EFHex	20Hex	Hue Control Register	00Hex
EHex	Subcarrier Frequency Register 2	E6Hex	21Hex	Brightness Control Register	00Hex
0FHex	Subcarrier Frequency Register 3	21Hex	22Hex	Sharpness Response Register	00Hex
10Hex	Subcarrier Phase Register	00Hex	23Hex	DNR 0	44Hex
11Hex	Closed Captioning Ext Register 0	00Hex	24Hex	DNR 1	20Hex
12Hex	Closed Captioning Ext Register 1	00Hex	25Hex	DNR 2	00Hex
			35Hex	Output Clock Register	70Hex

POWER-ON RESET REGISTER VALUES

POWER-ON RESET REG VALUES (PAL_NTSC = 0, NTSC Selected)

Address	Data
00Hex	Mode Register 0
01Hex	Mode Register 1
02Hex	Mode Register 2
03Hex	Mode Register 3
04Hex	Mode Register 4
05Hex	Mode Register 5
06Hex	Mode Register 6
07Hex	Mode Register 7
08Hex	Mode Register 8
09Hex	Mode Register 9
0AHex	Timing Register 0
0BHex	Timing Register 1
0CHex	Subcarrier Frequency Register 0
0DHex	Subcarrier Frequency Register 1
0EHex	Subcarrier Frequency Register 2
0FHex	Subcarrier Frequency Register 3
10Hex	Subcarrier Phase Register
11Hex	Closed Captioning Ext Register 0
12Hex	Closed Captioning Ext Register 1
13Hex	Closed Captioning Register 0
14Hex	Closed Captioning Register 1
15Hex	Pedestal Control Register 0
16Hex	Pedestal Control Register 1
17Hex	Pedestal Control Register 2
18Hex	Pedestal Control Register 3
19Hex	CGMS_WSS Reg 0
1AHex	CGMS_WSS Reg 1
1BHex	CGMS_WSS Reg 2
1CHex	Teletext Control Register
1DHex	Contrast Control Register
1EHex	Color Control Register 1
1FHex	Color Control Register 2
20Hex	Hue Control Register
21Hex	Brightness Control Register
22Hex	Sharpness Response Register
23Hex	DNR 0
24Hex	DNR 1
25Hex	DNR 2
26Hex	Gamma 0
27Hex	Gamma 1
28Hex	Gamma 2
29Hex	Gamma 3
2AHex	Gamma 4
2BHex	Gamma 5
2CHex	Gamma 6
2DHex	Gamma 7
2EHex	Gamma 8
2FHex	Gamma 9
30Hex	Gamma 10
31Hex	Gamma 11
32Hex	Gamma 12
33Hex	Gamma 13
34Hex	Brightness Detect Register
35Hex	Output Clock Register

POWER-ON RESET REG VALUES (PAL_NTSC = 1, PAL Selected)

Address	Data
00Hex	Mode Register 0
01Hex	Mode Register 1
02Hex	Mode Register 2
03Hex	Mode Register 3
04Hex	Mode Register 4
05Hex	Mode Register 5
06Hex	Mode Register 6
07Hex	Mode Register 7
08Hex	Mode Register 8
09Hex	Mode Register 9
0AHex	Timing Register 0
0BHex	Timing Register 1
0CHex	Subcarrier Frequency Register 0
0DHex	Subcarrier Frequency Register 1
0EHex	Subcarrier Frequency Register 2
0FHex	Subcarrier Frequency Register 3
10Hex	Subcarrier Phase Register
11Hex	Closed Captioning Ext Register 0
12Hex	Closed Captioning Ext Register 1
13Hex	Closed Captioning Register 0
14Hex	Closed Captioning Register 1
15Hex	Pedestal Control Register 0
16Hex	Pedestal Control Register 1
17Hex	Pedestal Control Register 2
18Hex	Pedestal Control Register 3
19Hex	CGMS_WSS Reg 0
1AHex	CGMS_WSS Reg 1
1BHex	CGMS_WSS Reg 2
1CHex	Teletext Control Register
1DHex	Contrast Control Register
1EHex	Color Control Register 1
1FHex	Color Control Register 2
20Hex	Hue Control Register
21Hex	Brightness Control Register
22Hex	Sharpness Response Register
23Hex	DNR 0
24Hex	DNR 1
25Hex	DNR 2
26Hex	Gamma 0
27Hex	Gamma 1
28Hex	Gamma 2
29Hex	Gamma 3
2AHex	Gamma 4
2BHex	Gamma 5
2CHex	Gamma 6
2DHex	Gamma 7
2EHex	Gamma 8
2FHex	Gamma 9
30Hex	Gamma 10
31Hex	Gamma 11
32Hex	Gamma 12
33Hex	Gamma 13
34Hex	Brightness Detect Register
35Hex	Output Clock Register

APPENDIX 9

NTSC WAVEFORMS (WITH PEDESTAL)

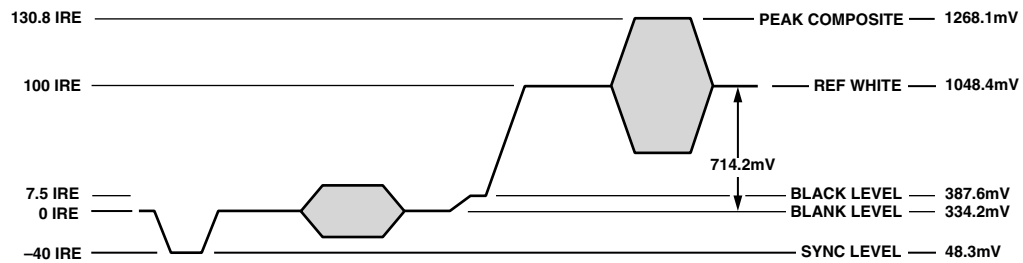

Figure 108. NTSC Composite Video Levels

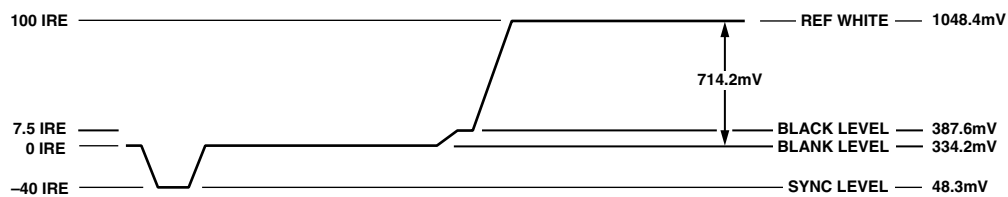

Figure 109. NTSC Luma Video Levels

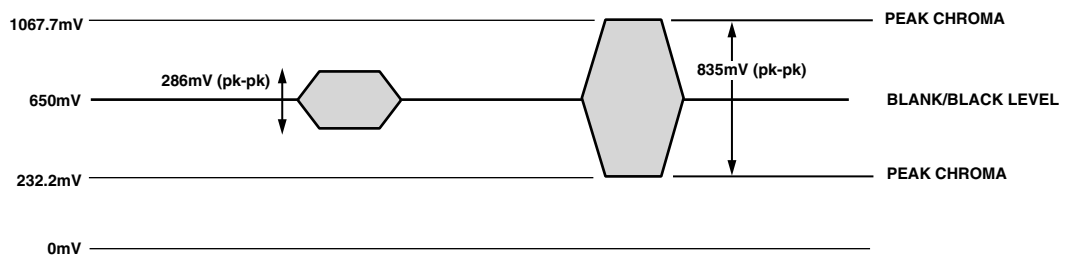

Figure 110. NTSC Chroma Video Levels

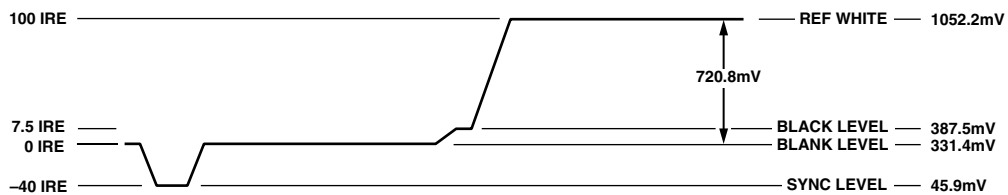

Figure 111. NTSC RGB Video Levels

NTSC WAVEFORMS (WITHOUT PEDESTAL)

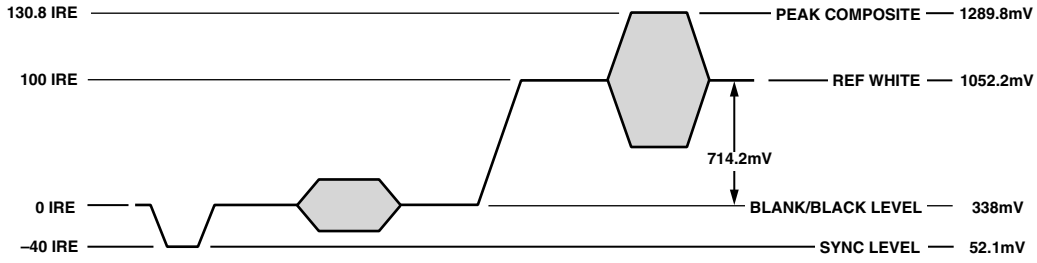

Figure 112. NTSC Composite Video Levels

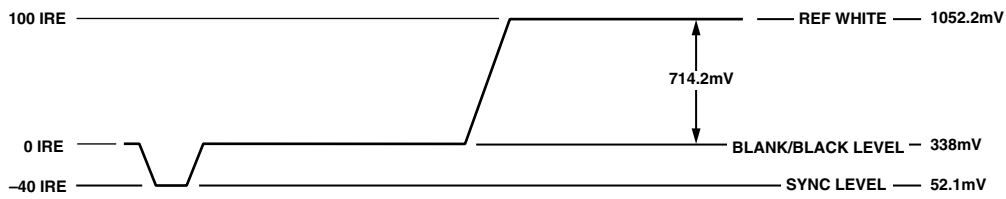

Figure 113. NTSC Luma Video Levels

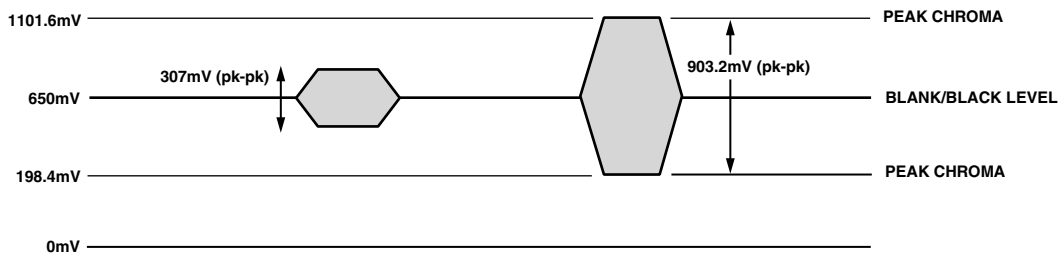

Figure 114. NTSC Chroma Video Levels

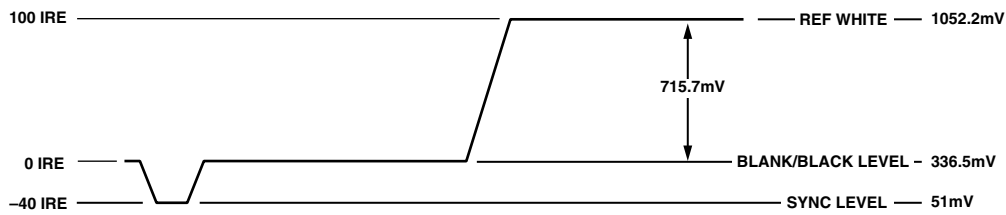

Figure 115. NTSC RGB Video Levels

PAL WAVEFORMS

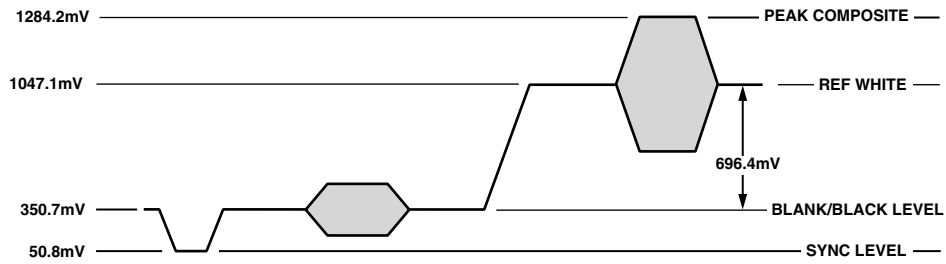

Figure 116. PAL Composite Video Levels

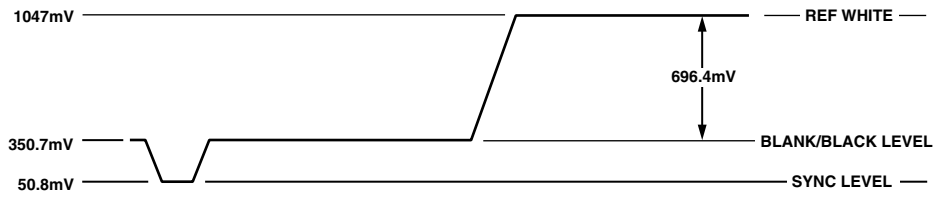

Figure 117. PAL Luma Video Levels

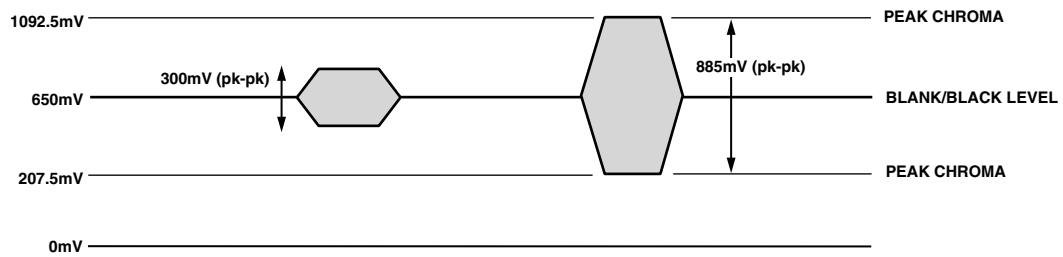

Figure 118. PAL Chroma Video Levels

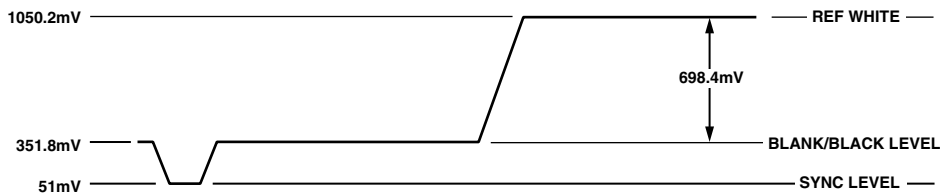

Figure 119. PAL RGB Video Levels

VIDEO MEASUREMENT PLOTS

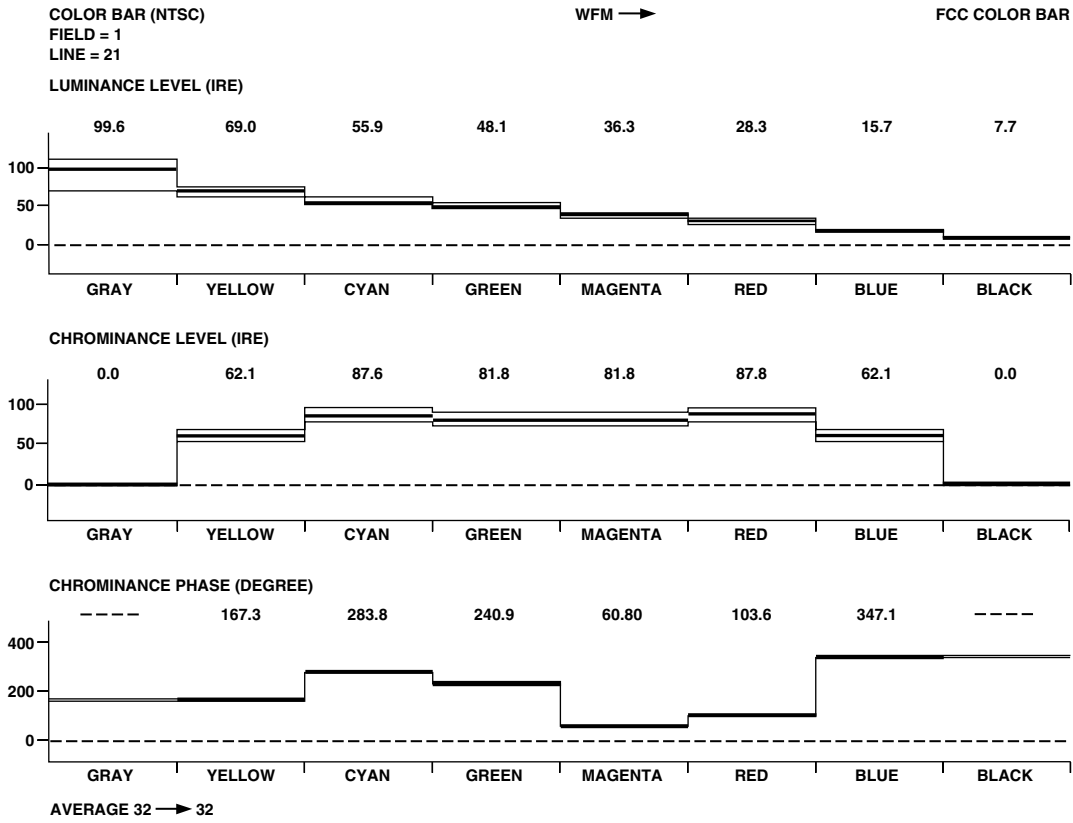

Figure 120. NTSC Color Bar Measurement

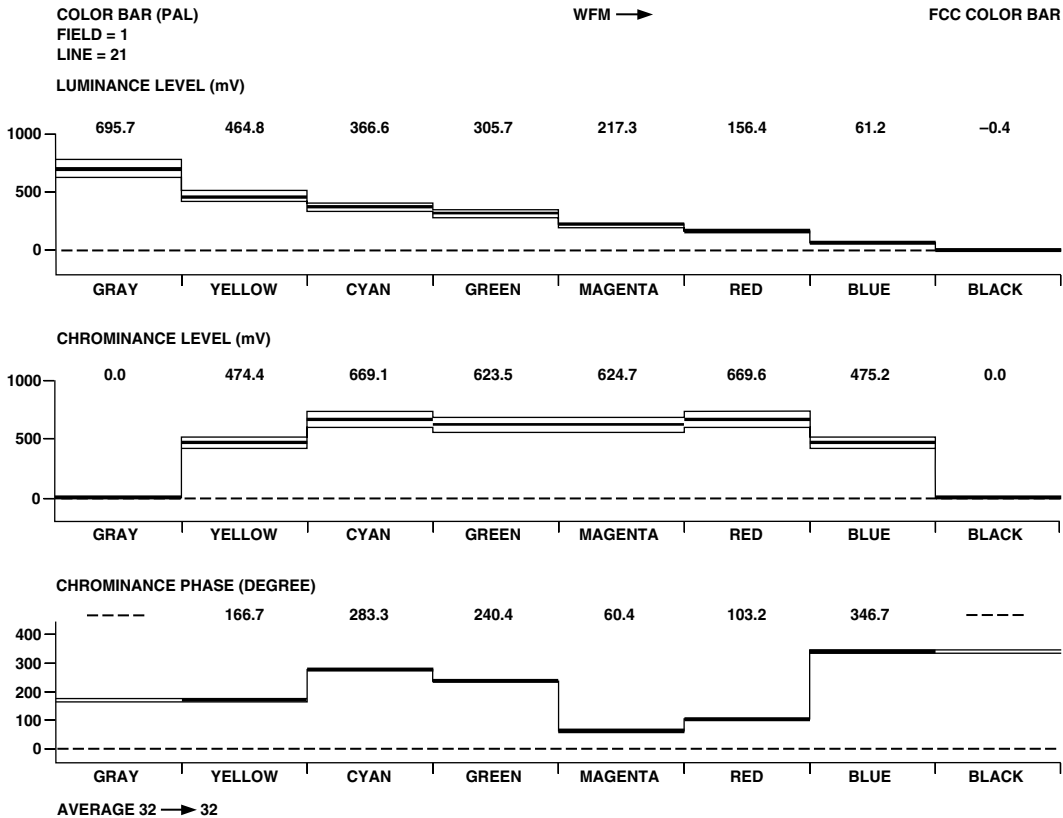

Figure 121. PAL Color Bar Measurement

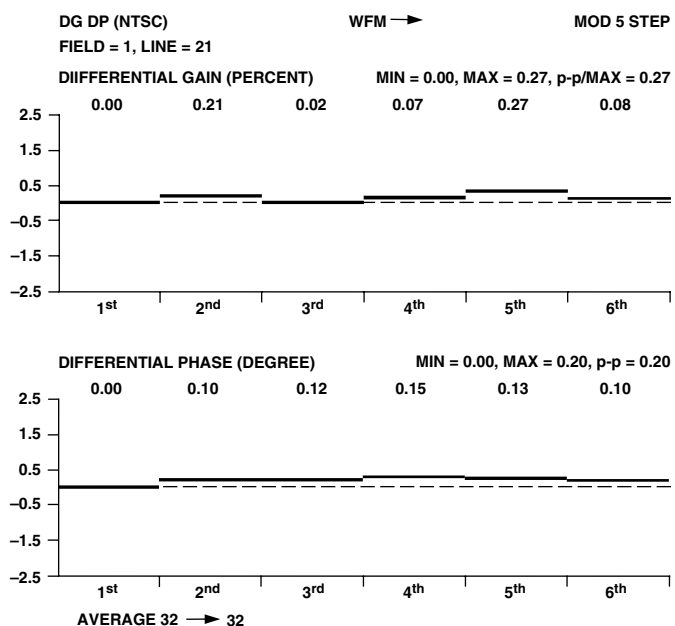

Figure 122. NTSC DG DP Measurement

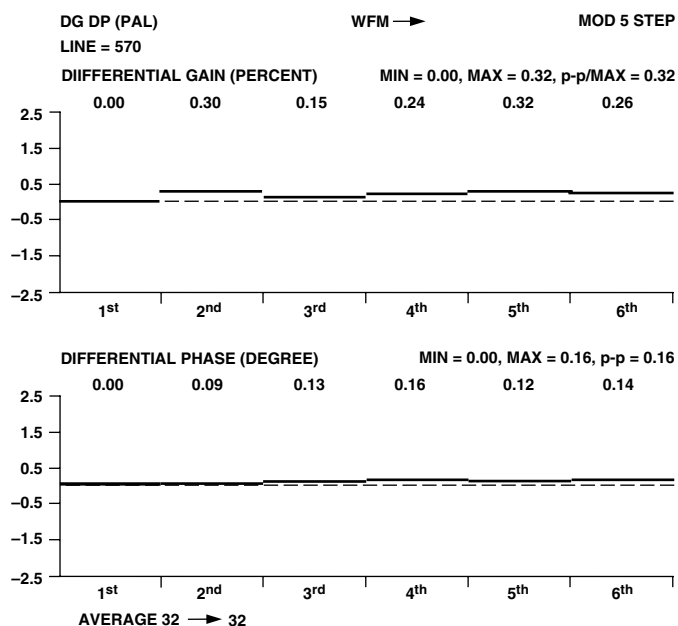

Figure 124. PAL DG DP Measurement

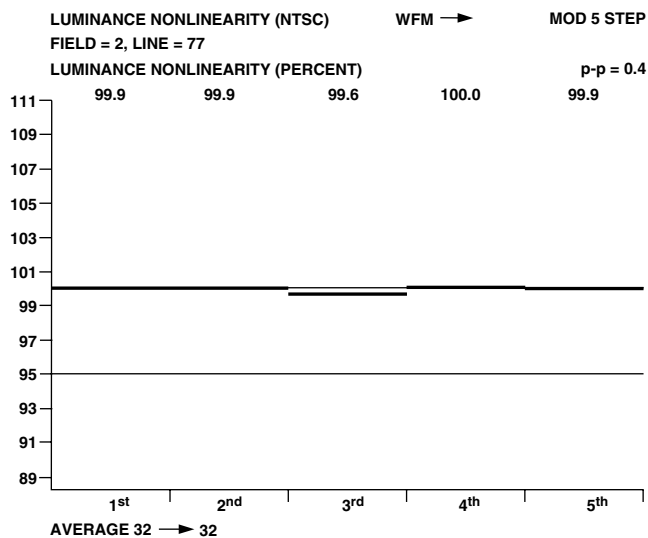

Figure 123. NTSC Luminance Nonlinearity

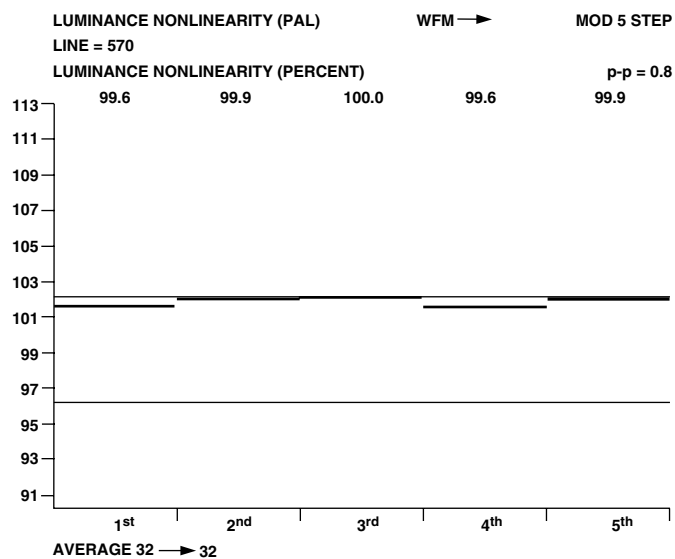

Figure 125. PAL Luminance Nonlinearity

ADV7192

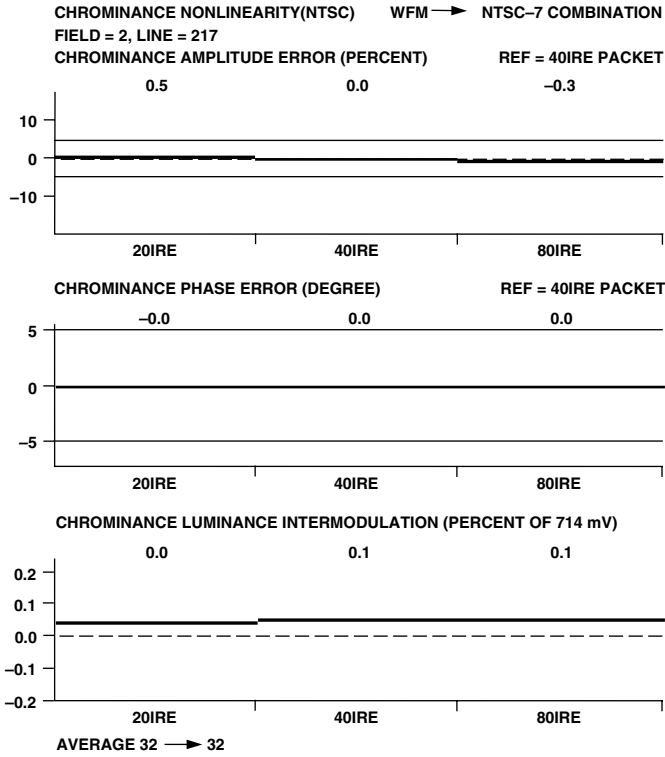

Figure 126. NTSC Chrominance Nonlinearity

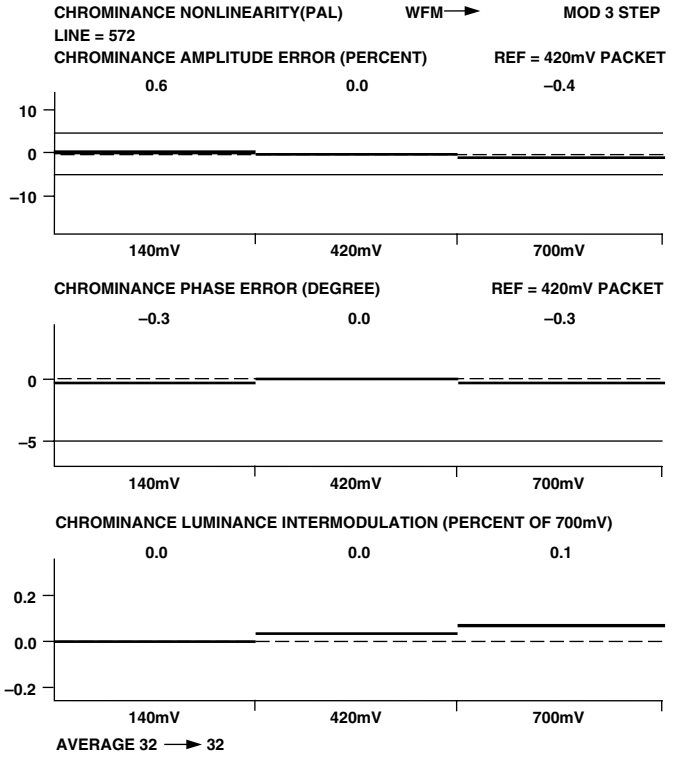

Figure 128. PAL Chrominance Nonlinearity

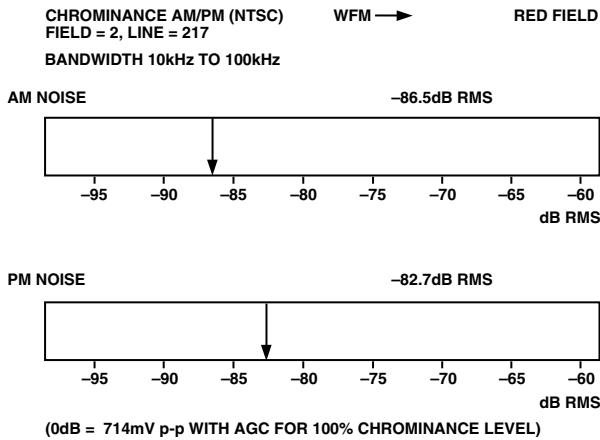

Figure 127. NTSC Chrominance AM/PM

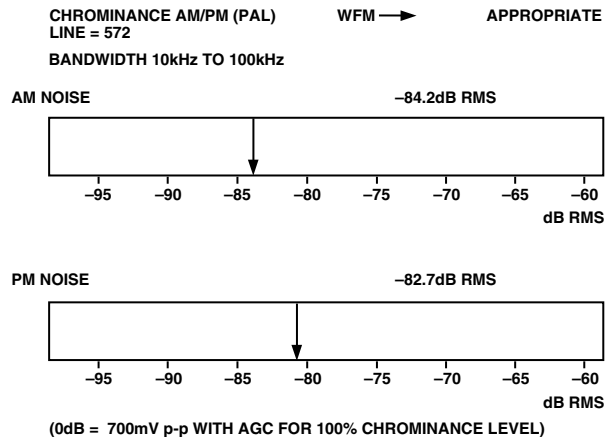

Figure 129. PAL Chrominance AM/PM

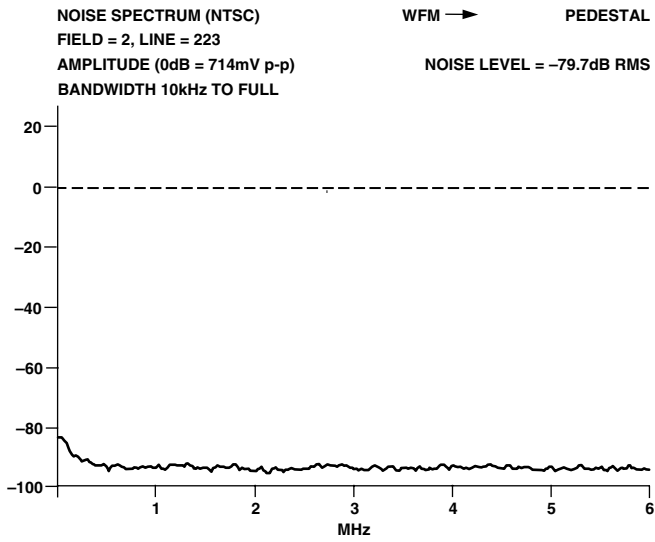

Figure 130. NTSC Noise Spectrum: Pedestal

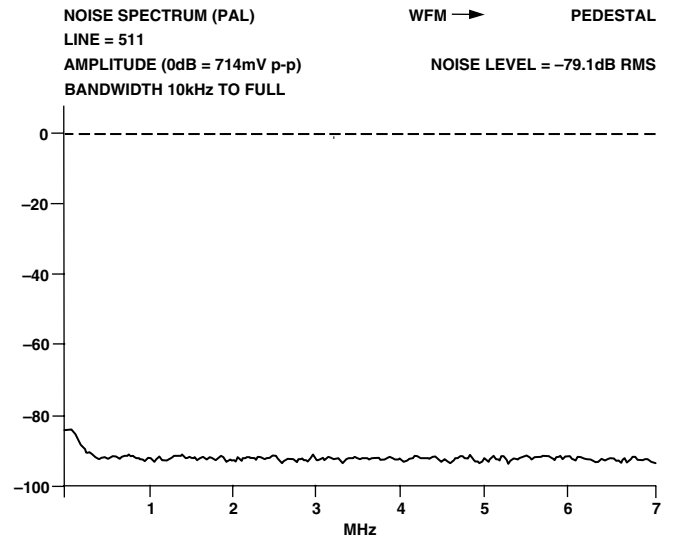

Figure 132. PAL Noise Spectrum: Pedestal

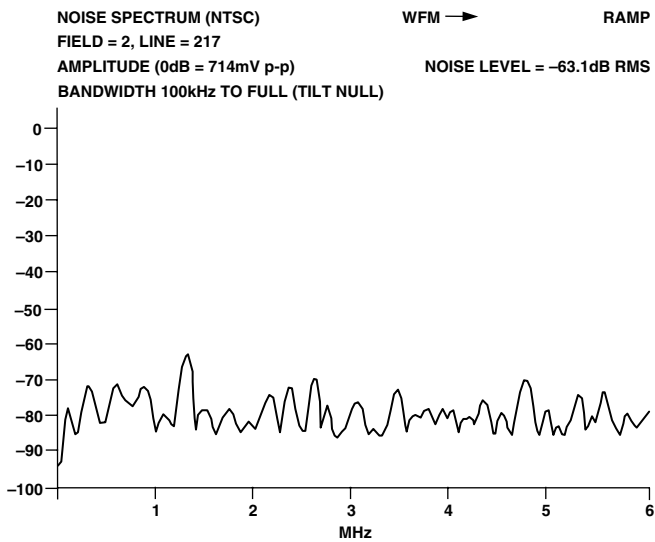

Figure 131. NTSC Noise Spectrum: Ramp

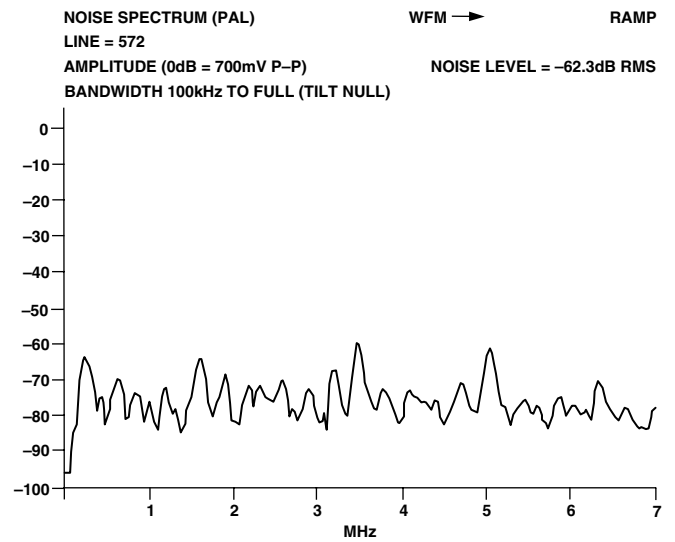

Figure 133. PAL Noise Spectrum: Ramp

UV WAVEFORMS

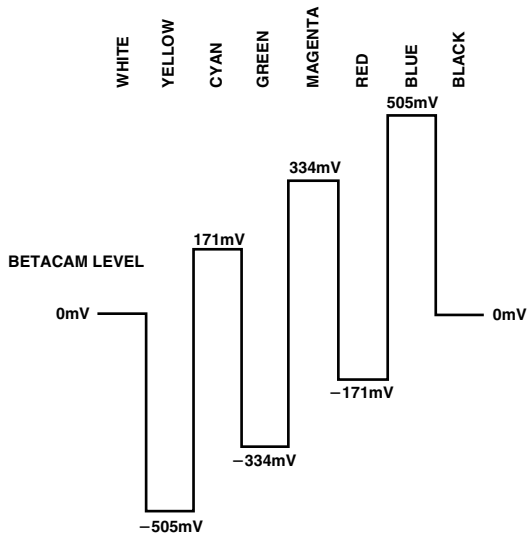

Figure 134. NTSC 100% Color Bars No Pedestal U Levels

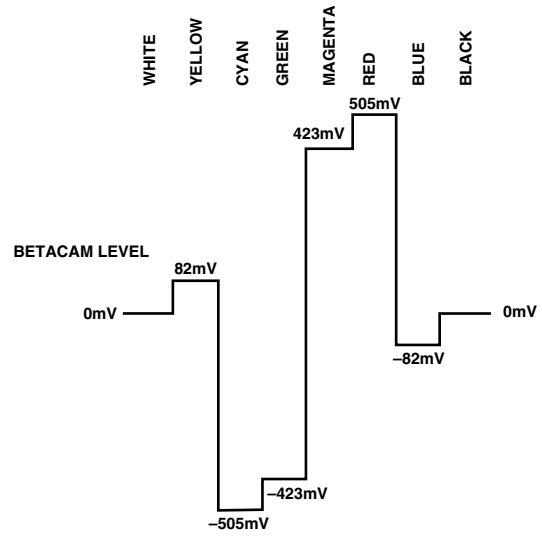

Figure 137. NTSC 100% Color Bars No Pedestal V Levels

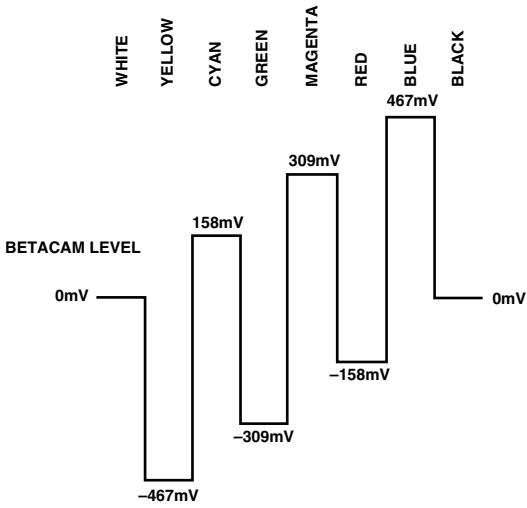

Figure 135. NTSC 100% Color Bars with Pedestal U Levels

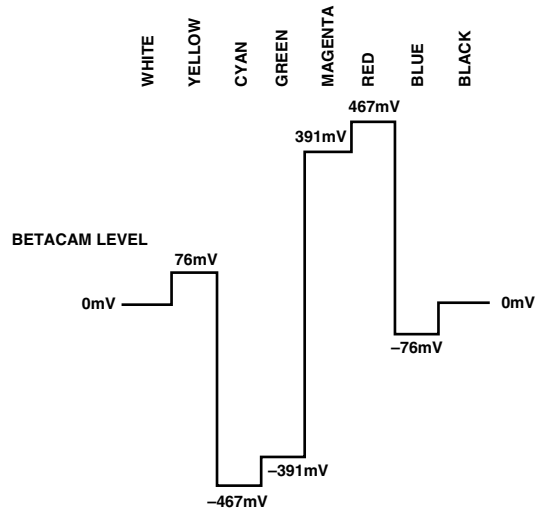

Figure 138. NTSC 100% Color Bars with Pedestal V

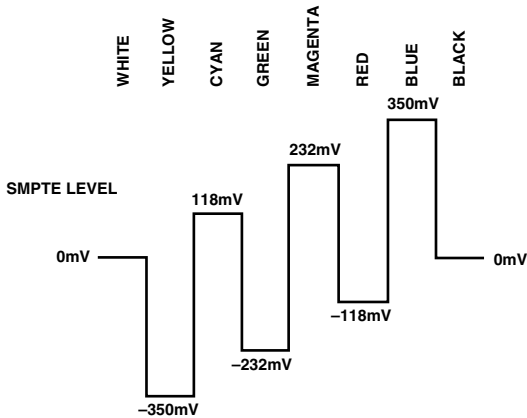

Figure 136. PAL 100% Color Bars U Levels

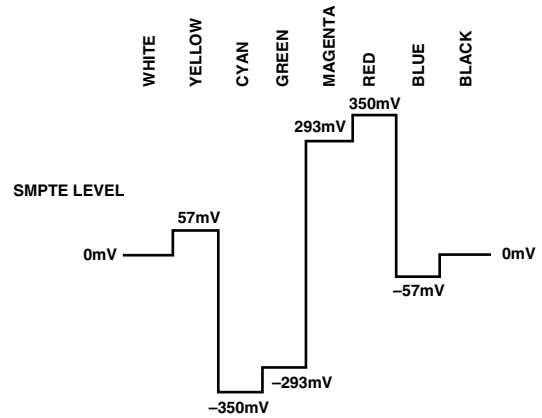

Figure 139. PAL 100% Color Bars V Levels

OUTPUT WAVEFORMS

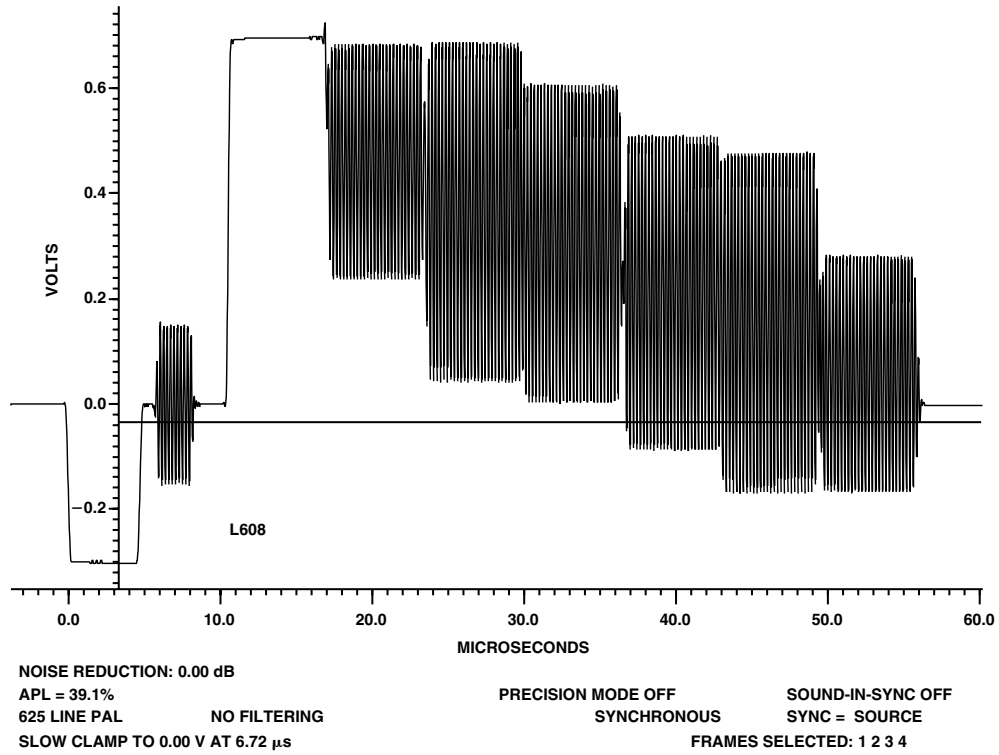

Figure 140. 100%/75% PAL Color Bars

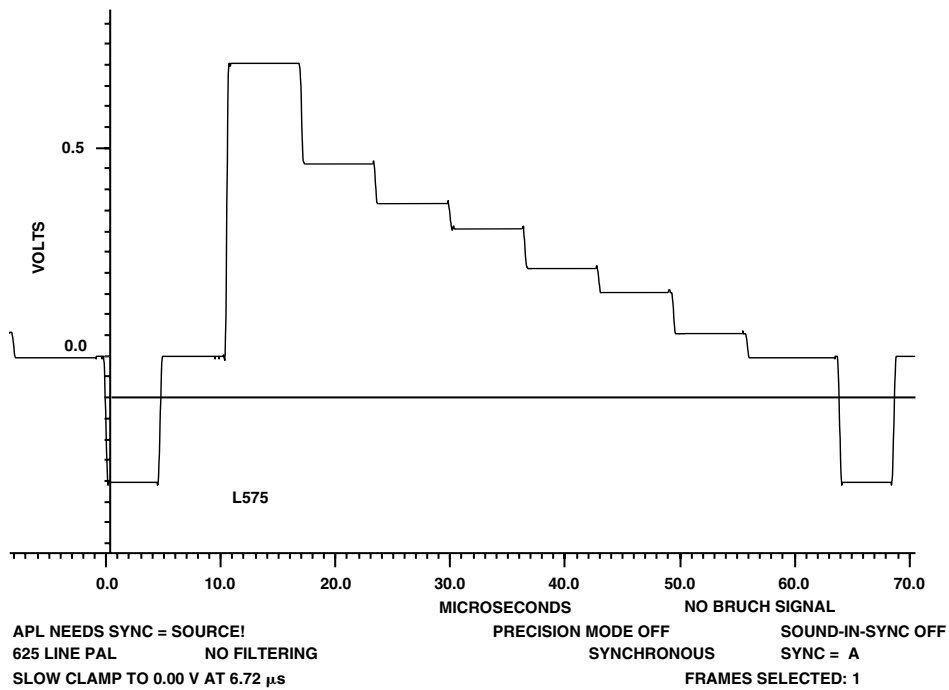

Figure 141. 100%/75% PAL Color Bars Luminance

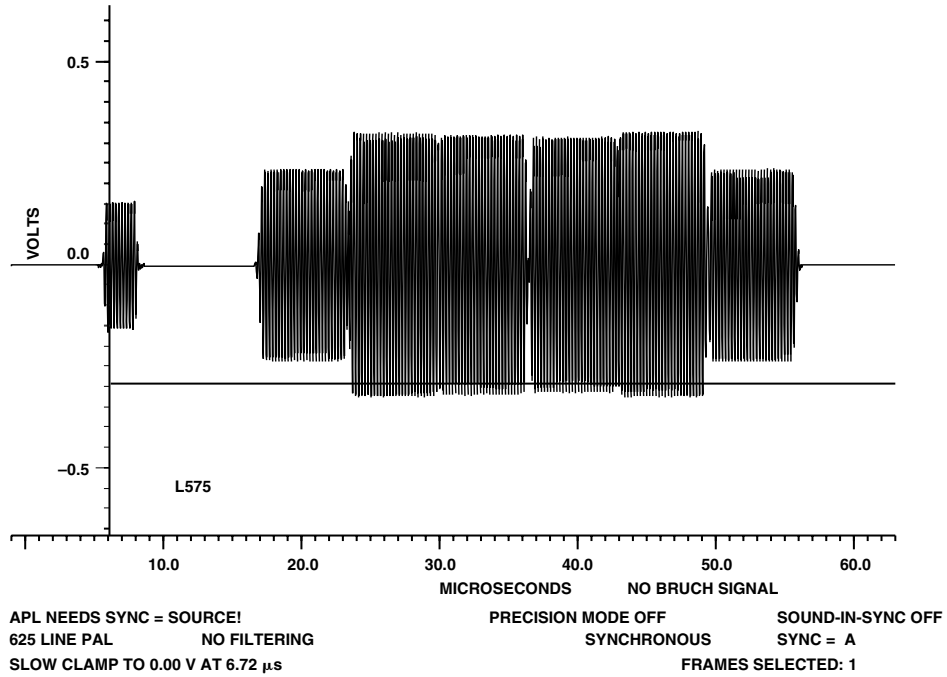

Figure 142. 100%/75% PAL Color Bars Chrominance

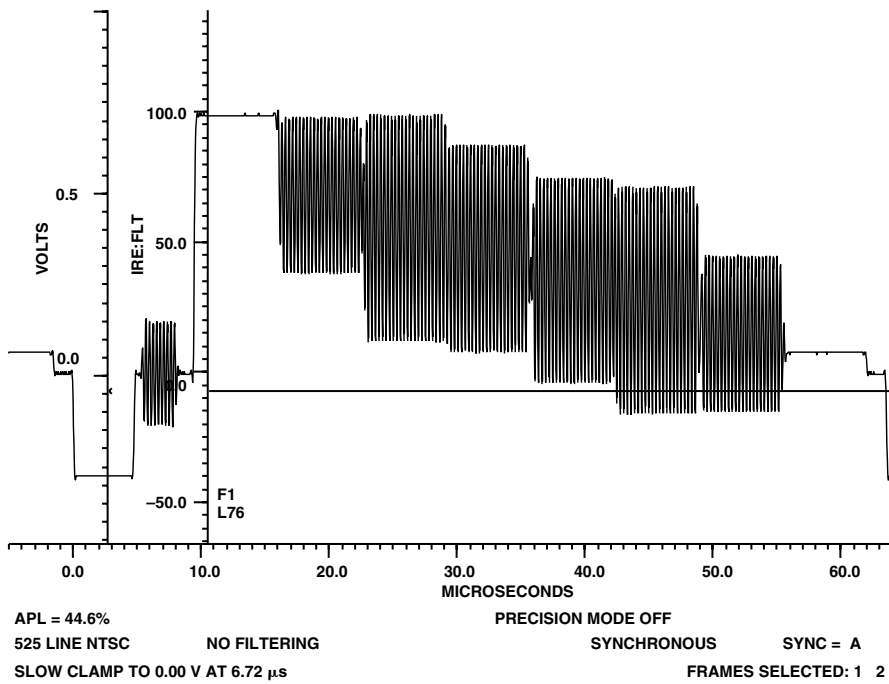
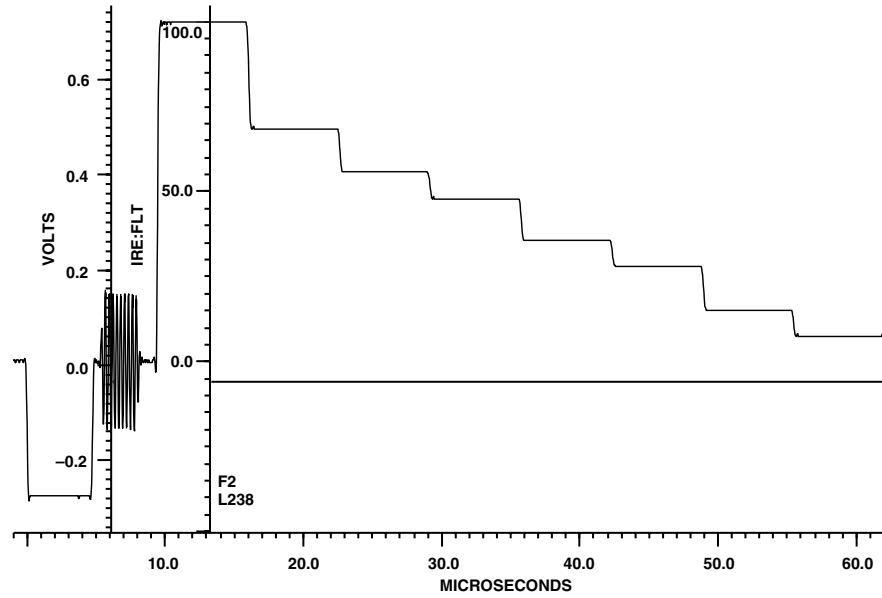

Figure 143. 100%/75% NTSC Color Bars



NOISE REDUCTION: 15.05dB
 APL = 44.7%
 525 LINE NTSC NO FILTERING
 SLOW CLAMP TO 0.00 V AT 6.72 μ S

PRECISION MODE OFF
 SYNCHRONOUS SYNC = SOURCE
 FRAMES SELECTED: 1 2

Figure 144. 100%/75% NTSC Color Bars Luminance

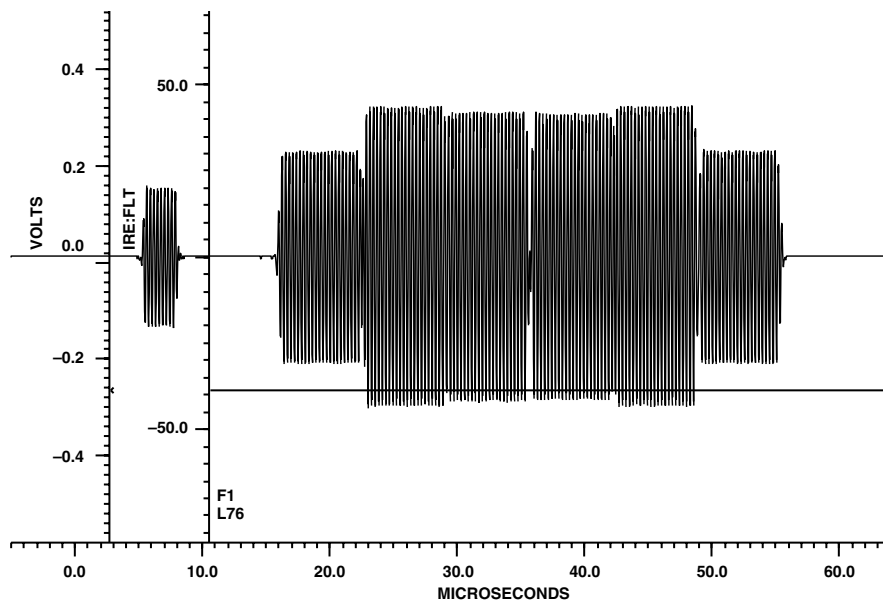

NOISE REDUCTION: 15.05dB
 APL NEEDS SYNC = SOURCE!
 525 LINE NTSC NO FILTERING
 SLOW CLAMP TO 0.00 V AT 6.72 μ S

PRECISION MODE OFF
 SYNCHRONOUS SYNC = B
 FRAMES SELECTED: 1 2

Figure 145. NTSC Color Bars Chrominance

APPENDIX 10
VECTOR PLOTS

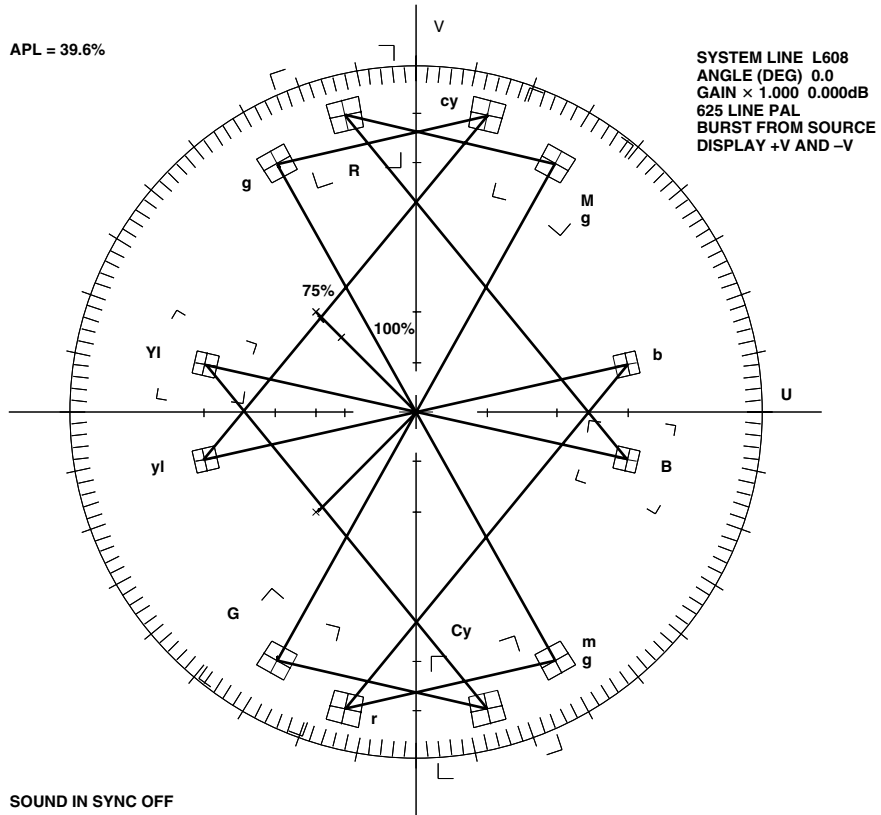

Figure 146. PAL Vector Plot

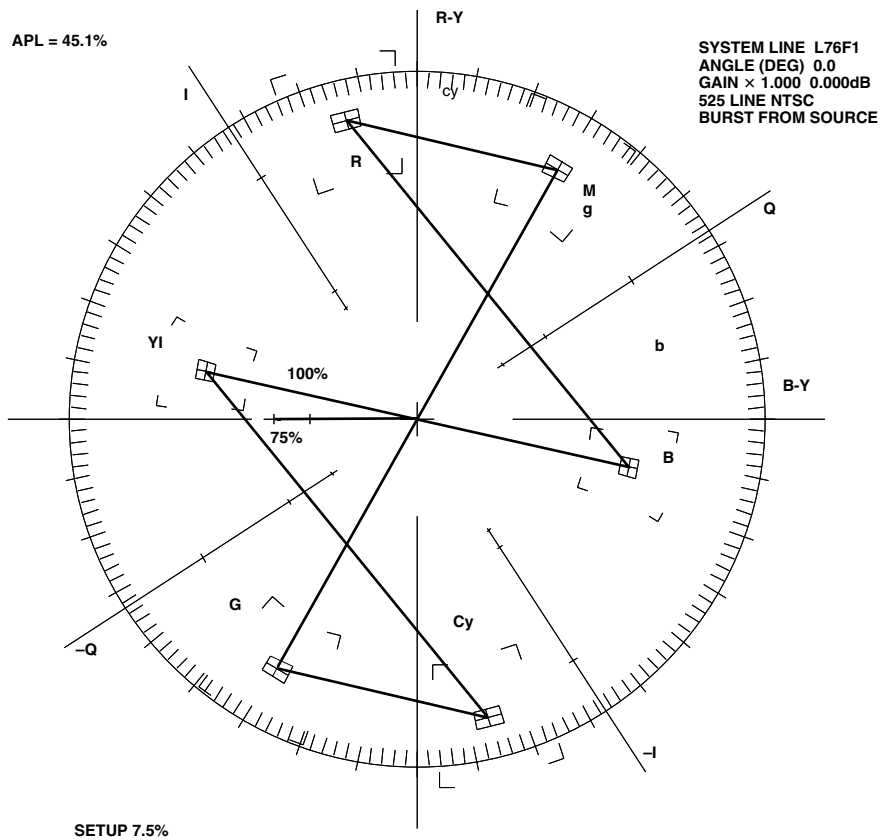

Figure 147. NTSC Vector Plot

OUTLINE DIMENSIONS

Dimensions shown in inches and (mm).

80-Lead LQFP
(ST-80)

