

## ADM1810–ADM1813/ADM1815–ADM1818

### FEATURES

Reliable Low Cost Voltage Monitor with Reset Output Supports Monitoring of Supplies Within 5%, 10%, 15% and 20% Tolerance

Active High and Low Push-Pull Output Choices (ADM1810, ADM1812, ADM1815 and ADM1817)

Open Drain Output Choices (ADM1811, ADM1813, ADM1816 and ADM1818)

Can Be Used with a Manual Push-Button to Generate a Reset (ADM1813, ADM1818)

Initialize Microprocessor Systems with Added Safety

### APPLICATIONS

Microprocessor Systems

Computers

Controllers

Intelligent Instruments

Automotive Systems

### GENERAL DESCRIPTION

The ADM181x range of voltage monitoring circuits can be used in any application where an electronic system needs to be reset when a voltage increases above or below a predetermined value.

Because of the “reset delay time” incorporated into the ADM181x series, these devices can provide a safe startup for electronic systems. Before a system initializes, the power supply must stabilize. Using the ADM181x series ensures that there are typically 150 ms for the power supply to stabilize before the system is reset and safe system initialization begins.

The ADM181x series of microprocessor reset circuits are available in low cost, space-saving SOT-23 packages.

### FUNCTIONAL BLOCK DIAGRAMS

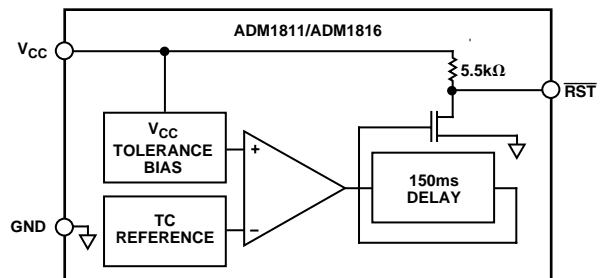
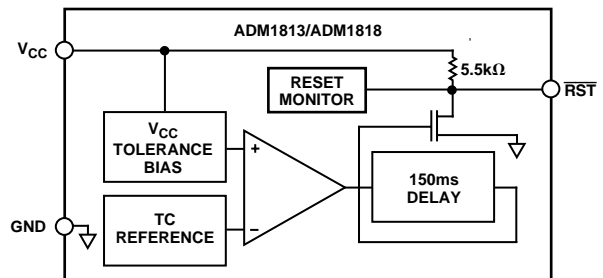
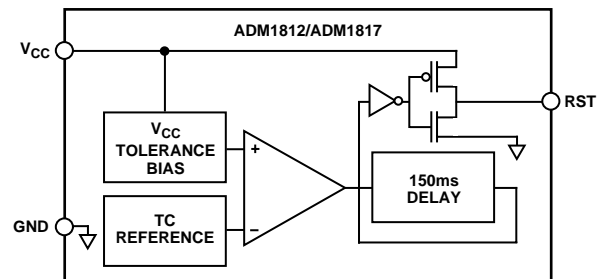
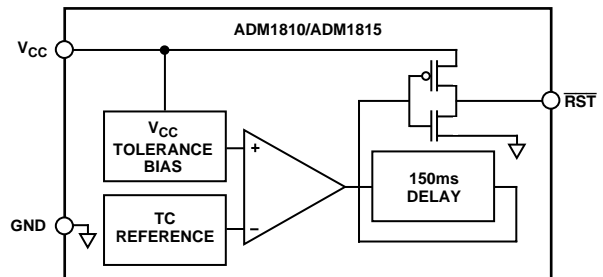

REV. 0

Information furnished by Analog Devices is believed to be accurate and reliable. However, no responsibility is assumed by Analog Devices for its use, nor for any infringements of patents or other rights of third parties which may result from its use. No license is granted by implication or otherwise under any patent or patent rights of Analog Devices.

# ADM1810–ADM1813/ADM1815–ADM1818–SPECIFICATIONS

(T<sub>A</sub> = –40°C to +85°C unless otherwise noted)

Parameter	Min	Typ	Max	Units	Test Conditions/Note
SUPPLY					
Voltage	1.2		5.5	V	
Current		30	40	μA	(ADM1810/ADM1811/ADM1813) V <sub>CC</sub> < 5.5 V, $\overline{\text{RST}}$ Output Open
		30	40	μA	(ADM1812) V <sub>CC</sub> < 5.5 V
		28	35	μA	(ADM1815/ADM1816/ADM1817/ADM1818) V <sub>CC</sub> < 5.5 V, $\overline{\text{RST}}$ Output Open
OUTPUT CURRENT	8	350		mA μA	@ 0.4 V, V <sub>CC</sub> ≥ 2.7 V* (ADM1810/ADM1812/ADM1815/ADM1817) @ 2.4 V, V <sub>CC</sub> ≥ 2.7 V
OUTPUT VOLTAGE	V <sub>CC</sub> – 0.5	V <sub>CC</sub> – 0.1		V	(ADM1810/ADM1812/ADM1815/ADM1817) @ 0 μA to 500 μA
V <sub>CC</sub> TRIP-POINT					
ADM1810-5, ADM1810-10, ADM1810-15/ ADM1811/ADM1812/ADM1813-5	4.50	4.62	4.75	V	(5%)
ADM1811/ADM1812/ADM1813-10	4.25	4.35	4.49	V	(10%)
ADM1811/ADM1812/ADM1813-15	4.00	4.13	4.24	V	(15%)
ADM1815/ADM1816/ADM1817/ ADM1818-5	2.98	3.06	3.15	V	(5%)
ADM1815/ADM1816/ADM1817/ ADM1818-10	2.80	2.88	2.97	V	(10%)
ADM1815/ADM1816/ADM1817/ ADM1818-20	2.47	2.55	2.64	V	(20%)
INTERNAL PULL-UP RESISTOR					
ADM1811/ADM1813/ADM1816/ADM1818	3.5	5.5	7.5	kΩ	
OUTPUT CAPACITANCE			10	pF	
RESET ACTIVE TIME	100	150	300	ms	
V <sub>CC</sub> DETECT TO $\overline{\text{RST}}$					
Falling		5	10	μs	(ADM1810/ADM1811/ADM1812/ADM1813)
		7	15	μs	(ADM1815/ADM1816/ADM1817/ADM1818)
Rising	100	150	300	ms	t <sub>R</sub> = 5 μs
PUSH-BUTTON DETECT TO $\overline{\text{RST}}$	1			μs	(ADM1813/ADM1818)
PUSH-BUTTON RESET					
	100	150	300	ms	(ADM1818) 2.7 V ≤ V <sub>CC</sub> ≤ 3.3 V
	100	150	300	ms	(ADM1813)

## NOTES

\*For ADM181x-20, V<sub>CC</sub> = V<sub>CCTP</sub>, sink current reduces to 8 mA.

Specifications subject to change without notice.

# ADM1810–ADM1813/ADM1815–ADM1818

## ORDERING GUIDE

Model*	Trip-Point	Package Option	Brand Information
<b>ADM1810-5ART-REEL</b>	4.62 V	<b>RT-3 (SOT-23)</b>	<b>MZV</b>
<b>ADM1810-5ART-REEL7</b>	4.62 V	<b>RT-3 (SOT-23)</b>	<b>MZV</b>
<b>ADM1810-10ART-REEL</b>	4.25 V	<b>RT-3 (SOT-23)</b>	<b>MZT</b>
<b>ADM1810-10ART-RL7</b>	4.25 V	<b>RT-3 (SOT-23)</b>	<b>MZT</b>
ADM1810-15ART-REEL	4.12 V	RT-3 (SOT-23)	MZQ
ADM1810-15ART-RL7	4.12 V	RT-3 (SOT-23)	MZQ
ADM1811-5ART-REEL	4.50 V	RT-3 (SOT-23)	M1V
ADM1811-5ART-RL7	4.50 V	RT-3 (SOT-23)	M1V
<b>ADM1811-10ART-REEL</b>	4.35 V	<b>RT-3 (SOT-23)</b>	<b>M1T</b>
<b>ADM1811-10ART-RL7</b>	4.35 V	<b>RT-3 (SOT-23)</b>	<b>M1T</b>
ADM1811-15ART-REEL	4.00 V	RT-3 (SOT-23)	M1Q
ADM1811-15ART-RL7	4.00 V	RT-3 (SOT-23)	M1Q
<b>ADM1812-5ART-REEL</b>	4.50 V	<b>RT-3 (SOT-23)</b>	<b>MTV</b>
<b>ADM1812-5ART-RL7</b>	4.50 V	<b>RT-3 (SOT-23)</b>	<b>MTV</b>
<b>ADM1812-10ART-REEL</b>	4.35 V	<b>RT-3 (SOT-23)</b>	<b>MTT</b>
<b>ADM1812-10ART-RL7</b>	4.35 V	<b>RT-3 (SOT-23)</b>	<b>MTT</b>
ADM1812-15ART-REEL	4.00 V	RT-3 (SOT-23)	MTQ
ADM1812-15ART-RL7	4.00 V	RT-3 (SOT-23)	MTQ
ADM1813-5ART-REEL	4.50 V	RT-3 (SOT-23)	M3V
ADM1813-5ART-RL7	4.50 V	RT-3 (SOT-23)	M3V
ADM1813-10ART-REEL	4.35 V	RT-3 (SOT-23)	M3T
ADM1813-10ART-RL7	4.35 V	RT-3 (SOT-23)	M3T
ADM1813-15ART-REEL	4.00 V	RT-3 (SOT-23)	M3Q
ADM1813-15ART-RL7	4.00 V	RT-3 (SOT-23)	M3Q
ADM1815-10ART-REEL	2.88 V	RT-3 (SOT-23)	M5E
ADM1815-10ART-RL7	2.88 V	RT-3 (SOT-23)	M5E
ADM1815-20ART-REEL	2.55 V	RT-3 (SOT-23)	M5A
ADM1815-20ART-RL7	2.55 V	RT-3 (SOT-23)	M5A
ADM1816-10ART-REEL	2.88 V	RT-3 (SOT-23)	M6E
ADM1816-10ART-RL7	2.88 V	RT-3 (SOT-23)	M6E
ADM1816-20ART-REEL	2.55 V	RT-3 (SOT-23)	M6A
ADM1816-20ART-RL7	2.55 V	RT-3 (SOT-23)	M6A
ADM1817-10ART-REEL	2.88 V	RT-3 (SOT-23)	M7E
ADM1817-10ART-RL7	2.88 V	RT-3 (SOT-23)	M7E
ADM1817-20ART-REEL	2.55 V	RT-3 (SOT-23)	M7A
ADM1817-20ART-RL7	2.55 V	RT-3 (SOT-23)	M7A
ADM1818-10ART-REEL	2.88 V	RT-3 (SOT-23)	M8E
ADM1818-10ART-RL7	2.88 V	RT-3 (SOT-23)	M8E
<b>ADM1818-20ART-REEL</b>	2.55 V	<b>RT-3 (SOT-23)</b>	<b>M8A</b>
<b>ADM1818-20ART-RL7</b>	2.55 V	<b>RT-3 (SOT-23)</b>	<b>M8A</b>

### NOTES

RL7 or REEL7 are in reels of 3000 parts. REEL are in reels of 10000 parts.

All models in bold are ex-stock. Consult factory for availability.

\*Only Available in Reels.

### ABSOLUTE MAXIMUM RATINGS\*

$V_{CC}$ .....	+1.2 V to +5.5 V
Input Current .....	40 $\mu$ A
Operating Temperature Range .....	-40°C to +85°C
Power Dissipation, RT-3, SOT-23 .....	320 mW
Derate by 4 mW/°C Above +70°C	
$\theta_{JA}$ Thermal Impedance .....	333°C/W
Lead Temperature (Soldering, 10 sec) .....	+300°C
Vapor Phase (60 sec) .....	+215°C
Infrared (15 sec) .....	+220°C
Storage Temperature Range .....	-65°C to +150°C
ESD Rating .....	3 kV

\*Typical values are measured at  $T_A = +25^\circ\text{C}$  unless otherwise noted.

## PIN CONFIGURATION

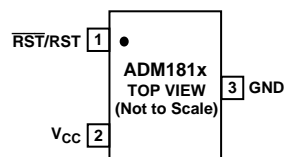

## PIN FUNCTION DESCRIPTIONS

Pin	Mnemonic	Function
1	$\overline{\text{RST}}/\text{RST}$	Reset Output. $\overline{\text{RST}}/\text{RST}$ remains active while $V_{CC}$ is below the reset threshold, and remains active for 150 ms (typ) after $V_{CC}$ rises above the reset threshold.
2	$V_{CC}$	Supply Voltage Being Monitored.
3	GND	0 V. Ground Reference for All Signals.

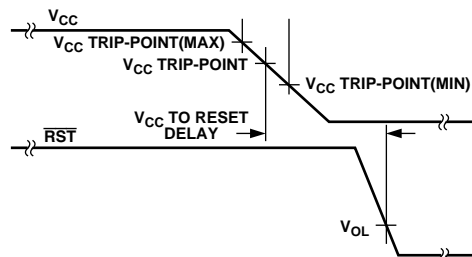

Figure 1. Power-Down Timing Diagram

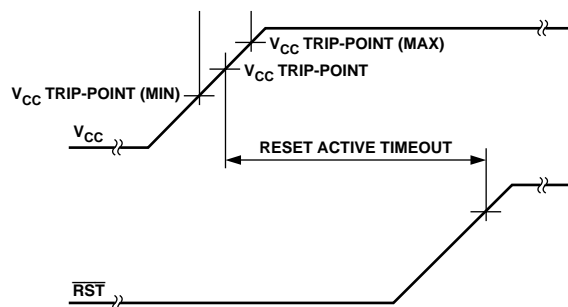

Figure 2. Power-Up Timing Diagram

# ADM1810-ADM1813/ADM1815-ADM1818

## ADM1813 AND ADM1818

The ADM1813 and ADM1818 are low cost voltage monitoring devices with the inclusion of an optional push-button reset function.

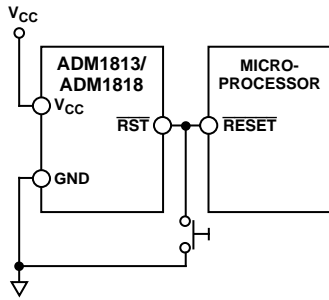

Figure 3. ADM1813/ADM1818 Typical Application

An optional push-button reset switch can be connected between RST and ground. Pressing this switch will pull the reset output low. If the push-button reset button pulls the RST output low for a period greater than 1  $\mu$ s, then, when the reset button releases the RST line to float high, the RST line will stay low for a further 150 ms typical.

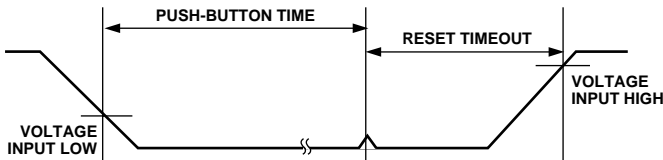

Figure 4. Push-Button Reset Timing Diagram

The ADM1818 range has options which allow the user to monitor 3.3 V supplies with 10% and 20% tolerance options. While the ADM1813 range has options which allow the user to monitor 5 V supplies with 5%, 10% and a 15% tolerance options.

## ADM1810, ADM1812, ADM1815 AND ADM1817

The ADM1812 is a 5 V low cost voltage monitor with an active high push-pull output. The ADM1812 supports 5%, 10% and 15% tolerances. The ADM1810 is similar to the ADM1812, except that the ADM1810 has an active low push-pull output.

The ADM1817 is 3.3 V voltage monitor with an active high push-pull output. The ADM1817 supports 5%, 10% and 20% tolerances. The ADM1815 is similar to the ADM1817, except that the ADM1815 has an active low push-pull output.

The ADM1810/ADM1812/ADM1815/ADM1817 can be connected directly to most microprocessor-reset inputs without the need for external components.

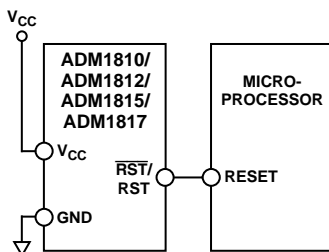

Figure 5. ADM1810/ADM1812/ADM1815/ADM1817 Typical Application

## ADM1811 AND ADM1816

The ADM1811 is a low cost voltage monitor with an open drain output. The ADM1811 is designed to monitor 5 V supplies. The ADM1811 range comes in three different variants which allow the monitoring of a 5 V supply with a tolerance of 5%, 10% and 15%. The ADM1816 is a 3.3 V version of the ADM1811 and supports 5%, 10% and 20% tolerance options.

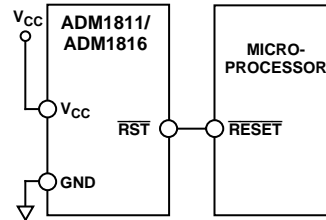

Figure 6. ADM1811/ADM1816 Typical Application

## OUTLINE DIMENSIONS

Dimensions shown in inches and (mm).

### 3-Lead Plastic Surface Mount Package (SOT-23) (RT-3)

