

## CX-1H-03

10kHz to 600kHz

MINIATURE QUARTZ CRYSTAL  
FOR SERIES OSCILLATORS

Page  
1 of 2

Telephone: +44(0)1460 230000  
Fax: +44(0)1460 230001  
Email: sales@euroquartz.co.uk  
Web: www.euroquartz.co.uk

## General Description

The CX-1H quartz crystal is a high quality tuning fork resonator designed for use in Series (two cascaded inverters) oscillators. The CX-1H is hermetically sealed in a rugged, miniature ceramic package, a quarter the size of an eight pin dual-in-line package. The crystal is manufactured utilizing a photo-lithographic process, ensuring consistency and repeatability of electrical characteristics.

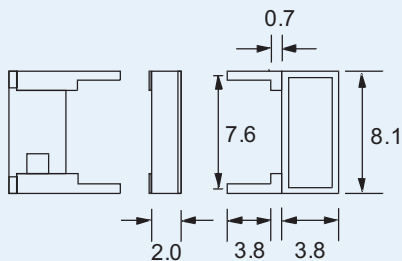

Outline and Dimensions

### Equivalent Circuit

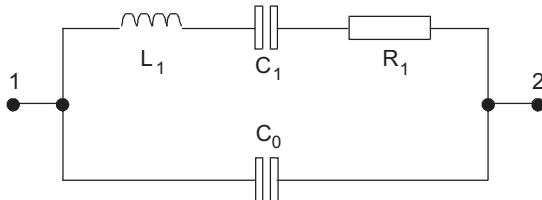

$R_1$  Motional Resistance     $L_1$  Motional Inductance  
 $C_1$  Motional Capacitance     $C_0$  Shunt Capacitance

### Conventional Series Oscillator Circuit

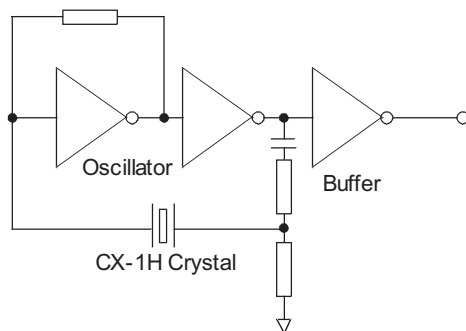

- Miniature tuning-fork design
- High shock resistance
- Designed for low-power applications
- Compatible with hybrid packaging
- Low ageing
- Full military environmental testing available

## Specification

<b>Frequency Range:</b>	10kHz to 600kHz
<b>Calibration Tolerance*:</b>	A, B, or C (see table below)
<b>Motional Resistance (<math>R_1</math>):</b>	Figure 1 2x Typ. @ 10~169.9kHz 2.5x Typ. @ 170~600kHz
<b>Motional Capacitance (<math>C_1</math>):</b>	Figure 2
<b>Quality Factor (Q):</b>	Figure 3 (Minimum is 0.25x Typ.)
<b>Shunt Capacitance (<math>C_0</math>):</b>	2.0pF max.
<b>Drive Level:</b>	1.5 $\mu$ W max. @ 10~24.9kHz 3.0 $\mu$ W max. @ 25~600kHz
<b>Turning Point (<math>T_0</math>)**:</b>	Figure 4
<b>Temperature Coefficient (k):</b>	-0.035ppm/ $^{\circ}$ C <sup>2</sup> $\pm$ 5ppm max.
<b>Ageing, first year:</b>	$\pm$ 5ppm max.
<b>Shock, survival***:</b>	1,000g 1ms, 1/2 sine
<b>Vibration, survival***:</b>	20g rms 10 - 2,000Hz
<b>Operating Temperature:</b>	-10 $^{\circ}$ ~+70 $^{\circ}$ C (commercial) -40 $^{\circ}$ ~+85 $^{\circ}$ C (industrial) -55 $^{\circ}$ ~+125 $^{\circ}$ C (military)
<b>Storage Temperature:</b>	-55 $^{\circ}$ C~+125 $^{\circ}$ C
<b>Process Temperature:</b>	Lead to Package temp. not to exceed 175 $^{\circ}$ C Glass lid to package seal rim temp. not to exceed 210 $^{\circ}$ C

Specifications are typical at 25 $^{\circ}$ C unless otherwise indicated.

\* Closer calibration available

\*\* Other turning point available

\*\*\* Higher shock and vibration available

### CX-1H Crystal Calibration Tolerance at 25 $^{\circ}$ C

Calibration	Frequency Range (kHz)			
	10~74.9	75~169.9	170~249.9	250~600
A	$\pm$ 0.003%	$\pm$ 0.005%	$\pm$ 0.01%	$\pm$ 0.02%
B	$\pm$ 0.01%	$\pm$ 0.01%	$\pm$ 0.02%	$\pm$ 0.05%
C	$\pm$ 0.1%	$\pm$ 0.1%	$\pm$ 0.2%	$\pm$ 0.5%

## CX-1H-03

10kHz to 600kHz

MINIATURE QUARTZ CRYSTAL  
FOR SERIES OSCILLATORS

Page  
2 of 2

Telephone: +44(0)1460 230000  
 Fax: +44(0)1460 230001  
 Email: sales@euroquartz.co.uk  
 Web: www.euroquartz.co.uk

### Package Handling

The CX crystal is hermetically sealed in a ceramic package. Normal handling and soldering precautions for small, low thermal mass parts are adequate when installing or testing CX crystals. The crystals may be wave soldered, taking proper precautions to avoid desoldering the leads. A slow machine rate or too high a pre-heat temperature or solder bath temperature can damage the crystals. Lead to package solder interface temperature should not exceed 175°C, and glass lid to package seal rim temperature should not exceed 210°C. Should the seal rim temperature exceed these limits the package may lose its hermeticity. Loss of hermeticity results in a decrease of frequency and increase in motional resistance.

Figure 1 - CX-1H Typical Motional Resistance (R1)

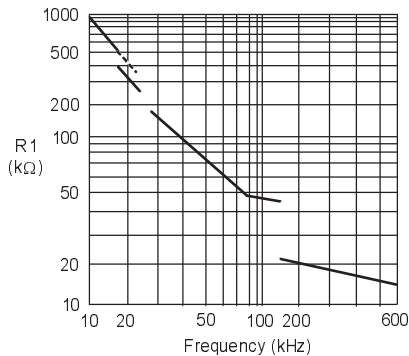

### Packaging

CX-1H-03 - Bulk Pack (Standard)  
 Tray Pack (Optional)

### Order Code

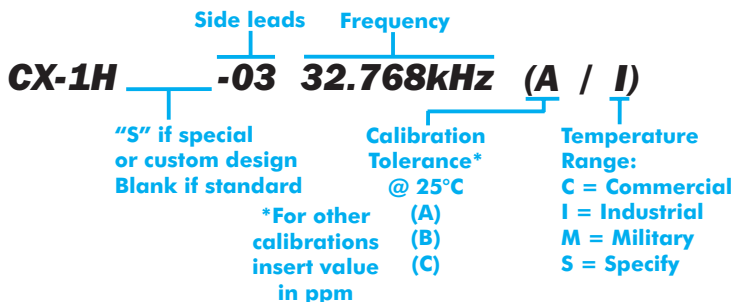

Figure 2 - CX-1H Typical Motional Capacitance (C1)

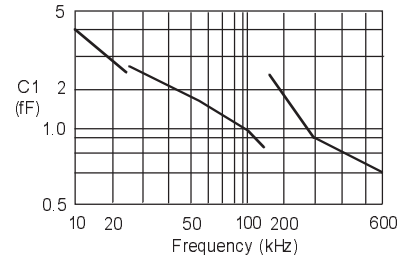

Figure 3 - CX-1H Typical Quality Factor (Q)

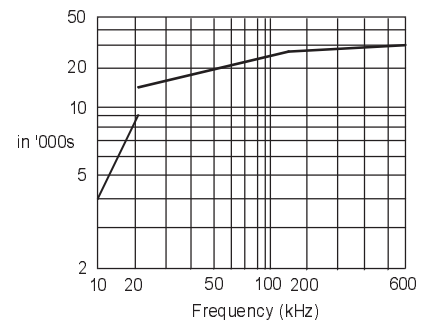
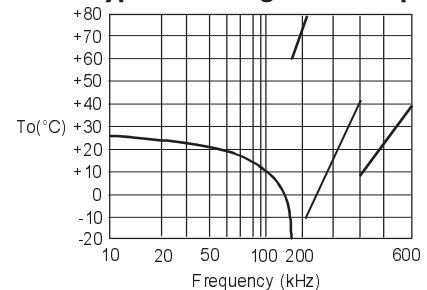

Figure 4 - CX-1H Typical Turning Point Temp. (°C)



$$\frac{f-f_0}{f_0} = k(T-T_0)^2$$