

### INTRODUCTION:

Adam Tech Crimp and Poke D-Sub connectors are a popular interface for many I/O applications. Offered in 9, 15, 25, 37 and 50 positions they are a low cost alternative to soldering a connector to cable. Contacts are crimped onto discrete wires and pushed into the connector body. The connector is comprised of a metal shell and plastic insulator and is available with a variety of mating options. The contacts are precision stamped and are available in a variety of platings.

### FEATURES:

- Low cost no solder alternative
- Industry standard compatibility
- Durable metal shell design
- Precision formed contacts
- Variety of Mating and mounting options

### MATING CONNECTORS:

Adam Tech D-Subminiatures and all industry standard D-Subminiature connectors.

### SPECIFICATIONS:

#### Material:

Insulator: PBT, 30% glass reinforced, rated UL94V-0  
Insulator Color: Black

Contacts: Phosphor Bronze  
Shell: Steel, Tin or Zinc plated  
Hardware: Brass, Nickel plated

#### Contact Plating:

Gold Flash (15 and 30  $\mu$ m Optional) over Nickel underplate.

#### Electrical:

Operating voltage: 250V AC / DC max.  
Current rating: 5 Amps max.  
Contact resistance: 20 m $\Omega$  max. initial  
Insulation resistance: 5000 M $\Omega$  min.  
Dielectric withstanding voltage: 1000V AC for 1 minute

#### Mechanical:

Insertion force: 0.75 lbs max  
Extraction force: 0.44 lbs min

#### Temperature Rating:

Operating temperature: -65°C to +125°C

#### PACKAGING:

Anti-ESD plastic trays

#### APPROVALS AND CERTIFICATIONS:

UL Recognized File No. E224053  
CSA Certified File No. LR1578596



### ORDERING INFORMATION HOUSING

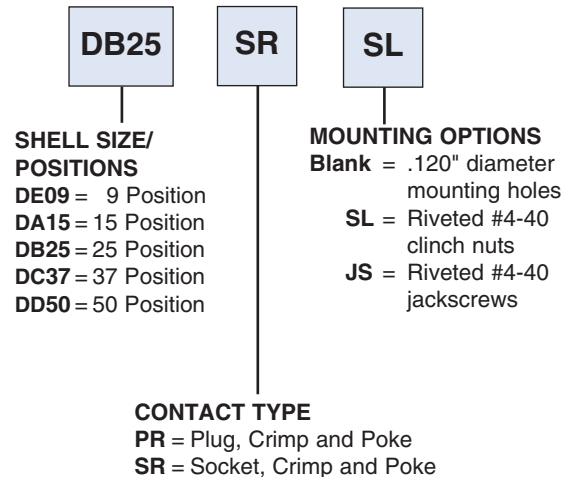

### CONTACTS

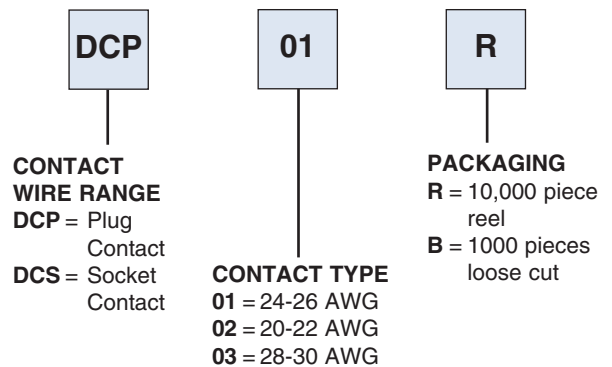

#### OPTIONS:

Add designator(s) to end of part number  
15 = 15  $\mu$ m gold plating in contact area on crimp contacts  
30 = 30  $\mu$ m gold plating in contact area on crimp contacts

### PLUG HOUSING

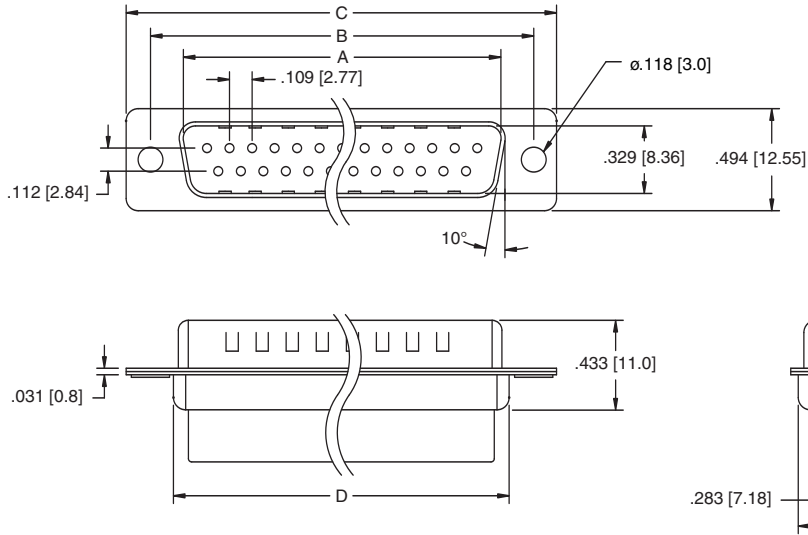

### MOUNTING OPTIONS

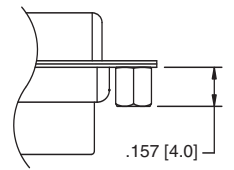

**SL Option**  
Bottom side riveted #4-40  
Clinch Nuts

### SOCKET HOUSING

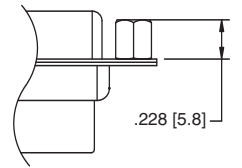
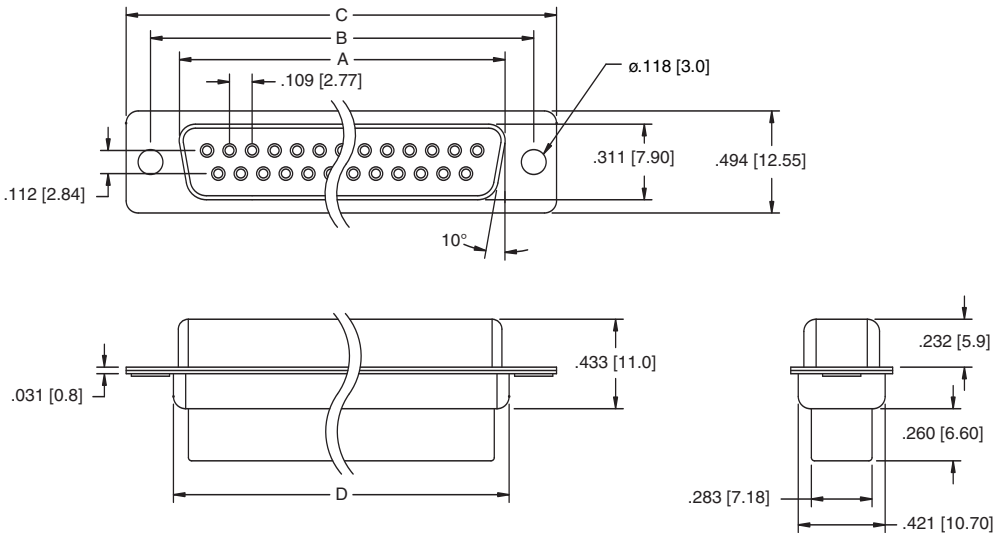

**JS Option**  
Top side riveted #4-40  
Jack Screws

### PLUG CRIMP CONTACTS

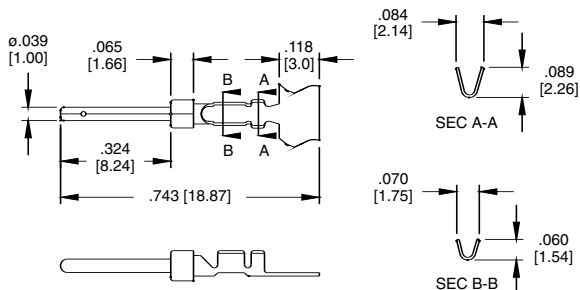

### SOCKET CRIMP CONTACTS

