

ETHERNET / CHEAPERNET LAN COUPLING TRANSFORMERS

FEATURES

- ① Designed to meet IEEE 802.3 (10 Base 2, 10 Base 5)
- ② Low Profile DIP or SMD Package
- ③ Low Leakage Inductance and Winding Capacitance
- ④ Fast Rise Times
- ⑤ 500 or 2000Vrms Minimum Isolation
- ⑥ Triple Core Package

ELECTRICAL SPECIFICATIONS AT 25°C PER CORE

PART NUMBER	TURNS RATIO (±5%)	PRIMARY OCL (μH ± 20%)	PRIMARY ET CONSTANT (V-μsec Min.)	RISE TIME (ns Max.)	PRI-SEC Cw/w (pf Max.)	PRI / SEC L _L (μH Max.)	DCR (Ohms Max.)	HIPOT Vrms Min.
A8DB101150	1:1	32	1.5	2.8	7.0	.15	.20	2000
D8DB101150	1:1	32	1.5	2.8	7.0	.15	.20	2000
D8CB101150	1:1	32	1.5	2.8	7.0	.15	.20	500
A8DB101170	1:1	40	1.7	3.0	8.0	.15	.25	2000
D8DB101170	1:1	40	1.7	3.0	8.0	.15	.25	2000
D8CB101170	1:1	40	1.7	3.0	8.0	.15	.25	500
A8DB101190	1:1	50	1.9	3.0	8.0	.20	.25	2000
D8DB101190	1:1	50	1.9	3.0	8.0	.20	.25	2000
D8CB101190	1:1	50	1.9	3.0	8.0	.20	.25	500
A8DB101240	1:1	75	2.4	3.2	9.0	.20	.30	2000
D8DB101240	1:1	75	2.4	3.2	9.0	.20	.30	2000
D8CB101240	1:1	75	2.4	3.2	9.0	.20	.30	500
A8DB101270	1:1	100	2.7	3.4	10.0	.25	.30	2000
D8DB101270	1:1	100	2.7	3.4	10.0	.25	.30	2000
D8CB101270	1:1	100	2.7	3.4	10.0	.25	.30	500
A8DB101330	1:1	150	3.3	3.5	12.0	.25	.30	2000
D8DB101330	1:1	150	3.3	3.5	12.0	.25	.30	2000
D8CB101330	1:1	150	3.3	3.5	12.0	.25	.30	500
D8DB101350	1:1	200	3.5	3.5	14.0	.30	.30	2000
D8CB101350	1:1	200	3.5	3.5	14.0	.30	.30	500
D8DB101370	1:1	250	3.7	3.6	16.0	.35	.30	2000
D8CB101370	1:1	250	3.7	3.6	16.0	.35	.30	500

PHYSICAL DIMENSIONS DIMENSIONS IN INCHES (mm)

NOTE: For Gull Wing Package Change "D8" to "G8"

SCHEMATIC DIAGRAM "B"

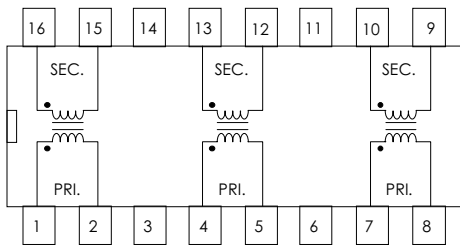

"D8" PACKAGE

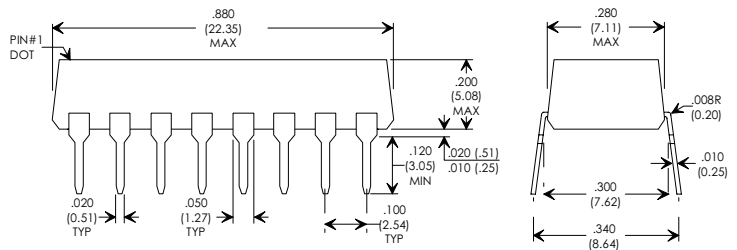

"A8" PACKAGE

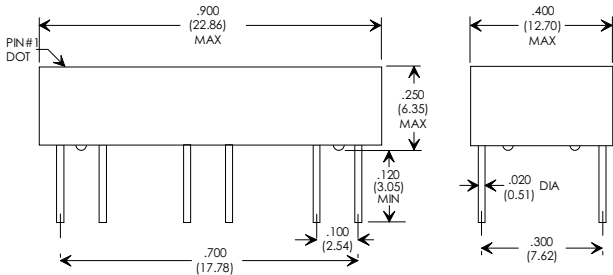

"G8" PACKAGE

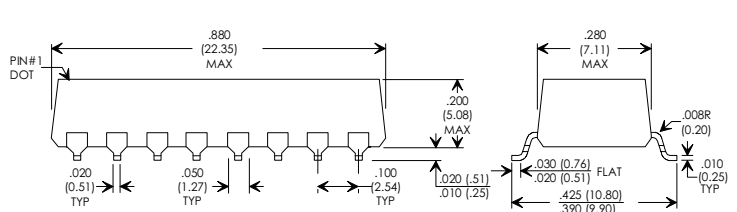

Specifications subject to change without notice.

ETHERNET / CHEAPERNET LAN COUPLING TRANSFORMERS

FEATURES

- ① Designed to meet IEEE 802.3 (10 Base 2, 10 Base 5)
- ② Low Profile soic Type SMD Package
- ③ Low Leakage Inductance and Winding Capacitance
- ④ Fast Rise Times
- ⑤ 2000Vrms Minimum Isolation
- ⑥ Triple Core Package

ELECTRICAL SPECIFICATIONS AT 25°C PER CORE

PART NUMBER	TURNS RATIO (±5%)	PRIMARY OCL (μH Min)	PRIMARY ET CONSTANT (V-μsec Min)	RISE TIME (ns Max.)	PRI / SEC Cw/w (pf Max)	PRI L _L (μH Max)	DCR (Ω Max) PRI / SEC	HIPOT Vrms Min	SCHEMATIC
TSD-470	1:1	35	2.1	1.6	5.0	.10	.15 / .15	2000	B
TSD-471	1:1	50	2.2	1.7	5.0	.10	.15 / .15	2000	B
TSD-472	1:1	75	2.4	1.8	7.0	.10	.17 / .17	2000	B
TSD-473	1:1	100	2.5	1.8	8.0	.10	.20 / .20	2000	B
TSD-474	1:1	150	3.0	2.5	10.0	.20	.30 / .30	2000	B
TSD-475	1:1	250	3.5	3.0	15.0	.25	.30 / .30	2000	B
TSD-842	1:1	90	3.0	1.8	10.0	.20	.30 / .30	2000	B

VARIATIONS AVAILABLE. FOR INTERMEDIATE VALUES AND/OR CUSTOM DESIGNS PLEASE CONSULT THE FACTORY.

SCHEMATIC DIAGRAM "B"

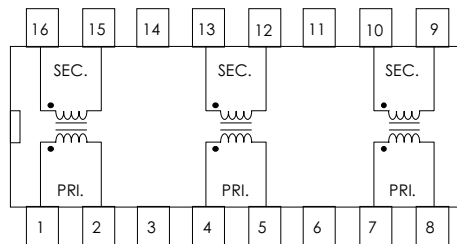

PHYSICAL DIMENSIONS IN INCHES (mm)

"G1" PACKAGE

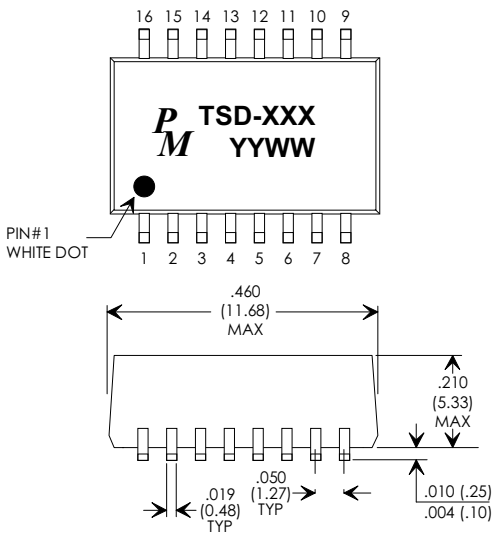
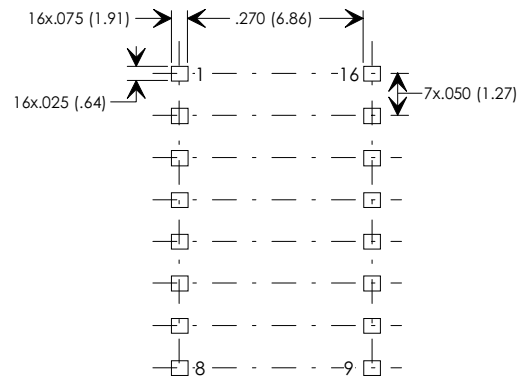

FIGURE 3: RECOMMENDED PCB LAYOUT DIMENSION IN INCHES, (mm)



Specifications subject to change without notice.