

INTRODUCTION:

Adam Tech Crimp and Poke D-Sub connectors are a popular interface for many I/O applications. Offered in 9, 15, 25, 37 and 50 positions they are a low cost alternative to soldering a connector to cable. Contacts are crimped onto discrete wires and pushed into the connector body. The connector is comprised of a metal shell and plastic insulator and is available with a variety of mating options. The contacts are precision stamped and are available in a variety of platings.

FEATURES:

- Low cost no solder alternative
- Industry standard compatibility
- Durable metal shell design
- Precision formed contacts
- Variety of Mating and mounting options

MATING CONNECTORS:

Adam Tech D-Subminiatures and all industry standard D-Subminiature connectors.

SPECIFICATIONS:

Material:

Insulator: PBT, 30% glass reinforced, rated UL94V-0
Insulator Color: Black

Contacts: Phosphor Bronze
Shell: Steel, Tin or Zinc plated
Hardware: Brass, Nickel plated

Contact Plating:

Gold Flash (15 and 30 μ m Optional) over Nickel underplate.

Electrical:

Operating voltage: 250V AC / DC max.
Current rating: 5 Amps max.
Contact resistance: 20 m Ω max. initial
Insulation resistance: 5000 M Ω min.
Dielectric withstanding voltage: 1000V AC for 1 minute

Mechanical:

Insertion force: 0.75 lbs max
Extraction force: 0.44 lbs min

Temperature Rating:

Operating temperature: -65°C to +125°C

PACKAGING:

Anti-ESD plastic trays

APPROVALS AND CERTIFICATIONS:

UL Recognized File No. E224053
CSA Certified File No. LR1578596



ORDERING INFORMATION HOUSING

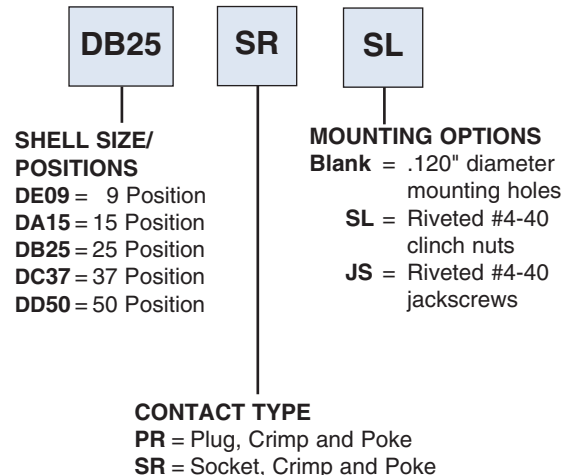

CONTACTS

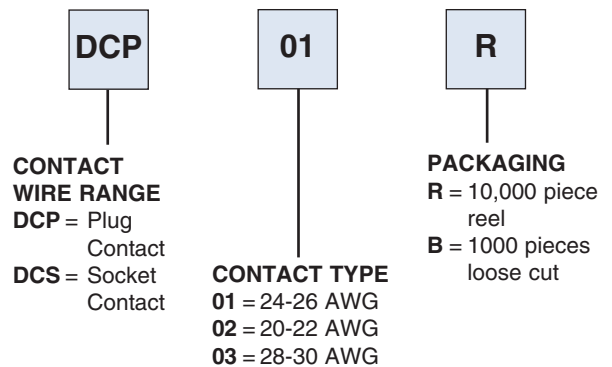

OPTIONS:

Add designator(s) to end of part number
15 = 15 μ m gold plating in contact area on crimp contacts
30 = 30 μ m gold plating in contact area on crimp contacts

PLUG HOUSING

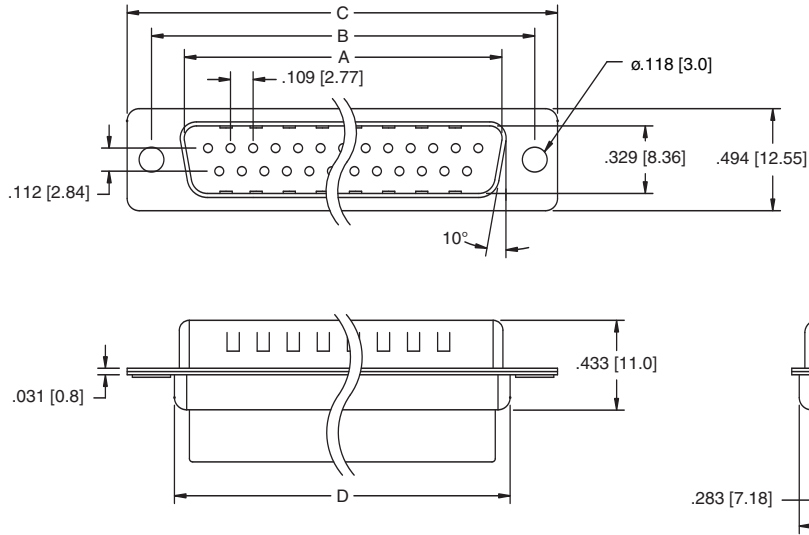

MOUNTING OPTIONS

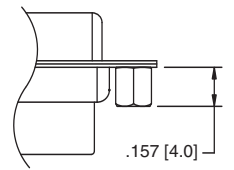

SL Option
Bottom side riveted #4-40
Clinch Nuts

SOCKET HOUSING

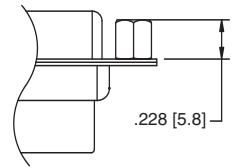
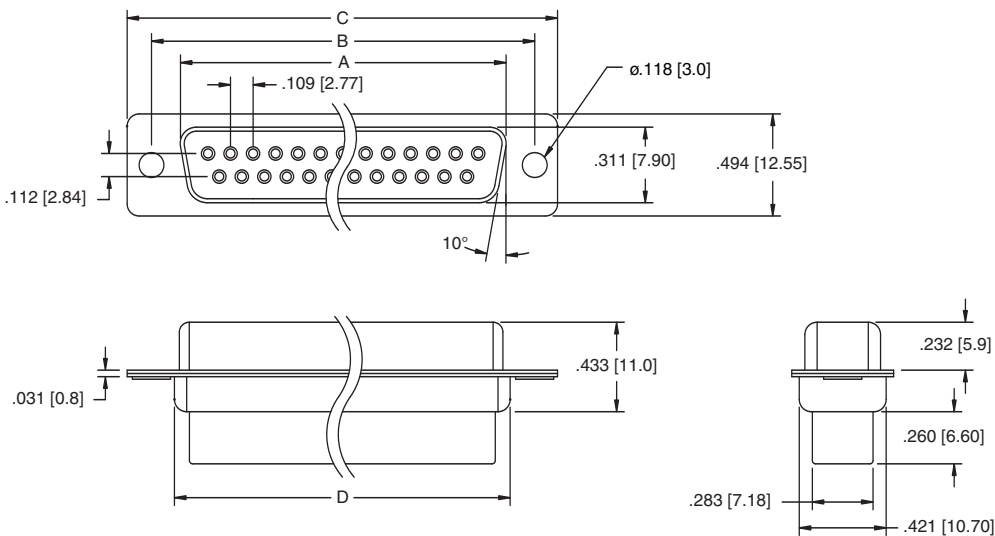

JS Option
Top side riveted #4-40
Jack Screws

PLUG CRIMP CONTACTS

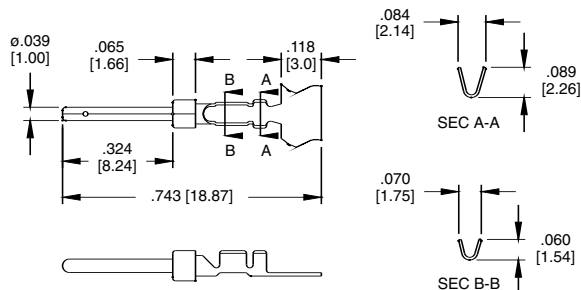

SOCKET CRIMP CONTACTS

