

1. CONFIGURATION & DIMENSIONS :

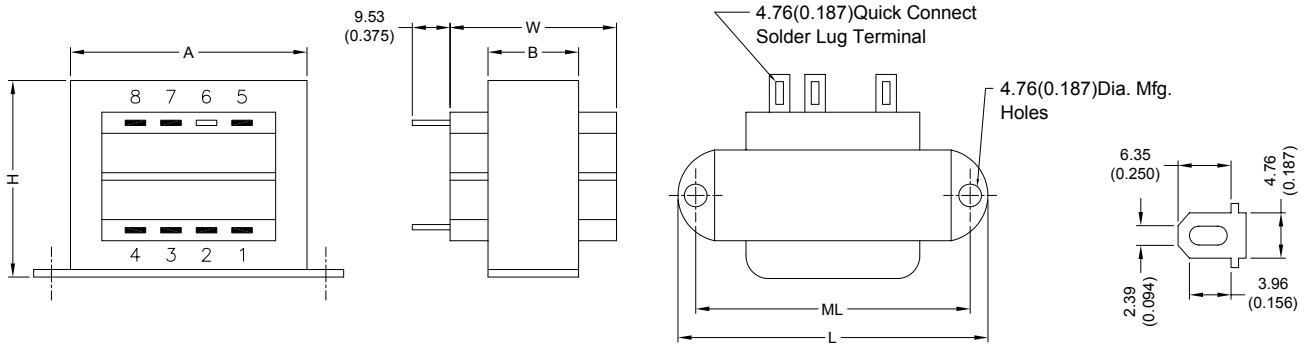

UNIT : mm (inch)

SIZE	VA	L	W	H	A	B	ML	gram
4	6	60.33 (2.375)	31.75 (1.250)	34.93 (1.375)	42.88 (1.688)	17.48 (0.688)	50.80 (2.000)	199.58

2. SCHEMATIC :

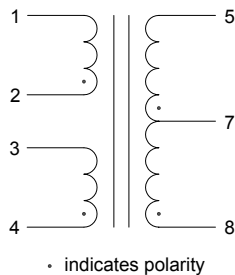

3. ELECTRICAL CHARACTERISTICS (@ 25°C) :

- | | |
|--------------------------------------|------------------------------|
| a. Primary Voltage | AC 115/230 V 50/60 Hz . |
| b. No Load Primary Current | Less Than 20mA / 25mA . |
| c. Secondary Voltage (±5%) | |
| Pin 5-8 C.T. Pin 7 | AC 7.40 V / 7.40 V . |
| d. Secondary Load Current | 1.00A . |
| e. Full Load Primary Current | Less Than 80mA / 45mA . |
| f. Full Load Secondary Voltage (±5%) | 6.00V / 6.00V . |
| Pin 5-8 C.T. Pin 7 | |
| g. DC Resistance | |
| Pin 1-2 | Primary-1 = 257 Ohm . |
| Pin 3-4 | Primary-2 = 317 Ohm . |
| Pin 5-7 | Secondary-1 = - Ohm . |
| Pin 7-8 | Secondary-2 = - Ohm . |
| h. Insulation Resistance | DC 500V 100Meg Ohm Of More . |
| i. Withstand Voltage (Hi-Pot) | AC 2500V 60Hz 1 Minutes . |
| j. Temperature Rise | Less Than 60 Deg C . |
| k. Core Size | EI-41 x 17.00 m/m . |

l. Turns & Wire Gauge

Primary-1	Pin 1-2	1600 Turns Diameter: 0.10 mm
Primary-2	Pin 3-4	1600 Turns Diameter: 0.10 mm
Secondary	Pin 5-7-8	52 x 2 Turns Diameter: 0.50 mm



RoHS Compliant

NOTE : Specifications subject to change without notice. Please check our website for latest information.

25.02.2008



SUPERWORLD ELECTRONICS (S) PTE LTD