

POWER TRANSFORMER

DCS5-36 (F) SERIES

1. CONFIGURATION & DIMENSIONS :

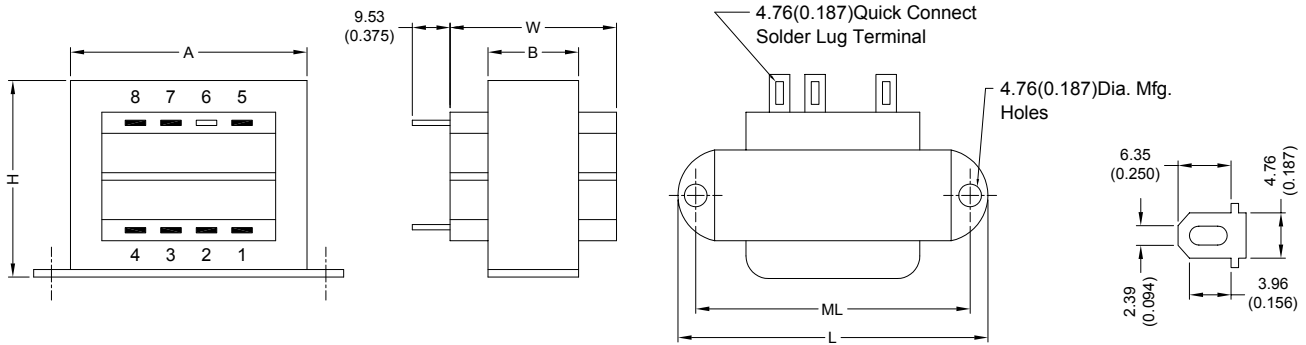

UNIT : mm (inch)

SIZE	VA	L	W	H	A	B	ML	gram
5	12	71.45 (2.813)	38.10 (1.500)	41.28 (1.625)	49.23 (1.938)	24.61 (0.969)	60.33 (2.375)	317.51

2. SCHEMATIC :

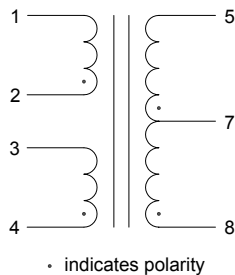

3. ELECTRICAL CHARACTERISTICS (@ 25°C) :

a. Primary Voltage	AC 115/230 V 50/60 Hz .
b. No Load Primary Current	Less Than 20mA / 25mA .
c. Secondary Voltage (±5%)	
Pin 5-8 C.T. Pin 7	AC 43.50 V / 43.20 V .
d. Secondary Load Current	0.35A .
e. Full Load Primary Current	Less Than 180mA / 95mA .
f. Full Load Secondary Voltage (±5%)	36.00V / 36.00V .
Pin 5-8 C.T. Pin 7	
g. DC Resistance	
Pin 1-2	Primary-1 = 124.80 Ohm .
Pin 3-4	Primary-2 = 144.50 Ohm .
Pin 5-7	Secondary-1 = 5.01 Ohm .
Pin 7-8	Secondary-2 = 5.01 Ohm .
h. Insulation Resistance	DC 500V 100Meg Ohm Of More .
i. Withstand Voltage (Hi-Pot)	AC 2500V 60Hz 1 Minutes .
j. Temperature Rise	Less Than 60 Deg C .
k. Core Size	EI-48 x 20.80 m/m .
l. Turns & Wire Gauge	
Primary-1 Pin 1-2	1027 Turns Diameter 0.13 mm
Primary-2 Pin 3-4	1027 Turns Diameter 0.13 mm
Secondary Pin 5-7-8	195 x 2 Turns Diameter 0.28 mm



RoHS Compliant

NOTE : Specifications subject to change without notice. Please check our website for latest information.

25.02.2008



SUPERWORLD ELECTRONICS (S) PTE LTD

PG. 1