

## Marketing Bulletin

**DATE:** August 25, 2005  
**TO:** All Sales Personnel  
**FROM:** Mark Stoner  
**RE:** Product Termination

To all concerned parties,

This bulletin is to notify all customers of the discontinuation of the following Ecliptek series effective August 25<sup>th</sup>, 2005:

<b>Series</b>	<b>Description</b>	<b>Recommended Replacement</b>
E11W1	5V 4 pad SMD LVPECL Oscillator	E13C7
E13W1	3.3V 4 pad SMD LVPECL Oscillator	E13C7

In compliance with our End of Life (EOL) policy, this will serve as advanced notice of product termination. New orders will not be accepted after November 25<sup>th</sup>, 2005, with delivery to conclude by February 25<sup>th</sup> 2006.

If there are any questions pertaining to this bulletin, please feel free to contact me. Thank you again for your cooperation.

Best Regards,



Mark W. Stoner  
Director of Marketing  
Ecliptek Corporation

# E11W1 Series

- PECL Output Oscillators
- 5.0V supply voltage
- 4 pad PCB SMD package
- Stability to 20ppm
- Output Enable/Disable available
- Complementary Output available
- Available on Tape and Reel

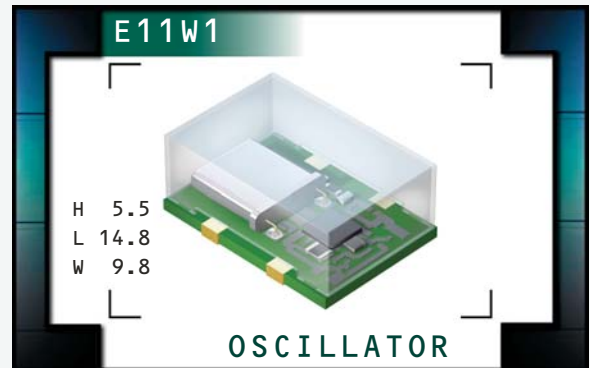

## NOTES

OBSOLETE

### ELECTRICAL SPECIFICATIONS

<b>Frequency Range</b>		19.440MHz to 250.000MHz
<b>Operating Temperature Range</b>		0°C to 70°C
	Available at Frequencies $\leq$ 212.500MHz	-40°C to 85°C
<b>Storage Temperature Range</b>		-55°C to 125°C
<b>Supply Voltage (<math>V_{CC}</math>)</b>		5.0V <sub>DC</sub> $\pm$ 5%
<b>Input Current</b>		100mA Maximum
<b>Logic Type</b>		100KH
<b>Frequency Tolerance / Stability</b>	Inclusive of all conditions: Calibration Tolerance at 25°C, Frequency Stability over the Operating Temperature Range, Supply Voltage Change, Output Load Change, Aging, Shock, and Vibration	$\pm$ 100ppm, $\pm$ 50ppm, $\pm$ 25ppm, or $\pm$ 20ppm Maximum
<b>Output Voltage Logic High (<math>V_{OH}</math>)</b>		$V_{CC}$ -1.025V <sub>DC</sub> Minimum
<b>Output Voltage Logic Low (<math>V_{OL}</math>)</b>		$V_{CC}$ -1.620V <sub>DC</sub> Maximum
<b>Rise Time / Fall Time</b>	20% to 80% of waveform	2 nSeconds Maximum
<b>Duty Cycle</b>	at 50% of waveform	50 $\pm$ 10(%) 50 $\pm$ 5(%)
<b>Load Drive Capability</b>		50 Ohms into $V_{CC}$ -2.0V <sub>DC</sub>
<b>Logic Control / Additional Output</b>		No Connect, Enable/Disable, or Complementary Output
<b>Enable/Disable Input Voltage</b>	$V_{IL}$ of $V_{CC}$ -1.475V <sub>DC</sub> Maximum No Connection $V_{IH}$ of $V_{CC}$ -1.165V <sub>DC</sub> Minimum	Enables Output Enables Output Disables Output: Logic Low
<b>Start Up Time</b>		10 mSeconds Maximum
<b>RMS Phase Jitter</b>	FJ = 12kHz to 20MHz	1 pSec Maximum

MANUFACTURER ECLIPTEK CORP.	CATEGORY OSCILLATOR	SERIES E11W1	PACKAGE 4-PCB	VOLTAGE 5.0V	CLASS 0S77	REV. DATE 01/03
--------------------------------	------------------------	-----------------	------------------	-----------------	---------------	--------------------

## PART NUMBERING GUIDE

### E11W1 F 2 C - 155.520M TR

#### FREQUENCY TOLERANCE & STABILITY/ OPERATING TEMPERATURE RANGE

C=±100ppm Maximum over 0°C to +70°C  
 D=±50ppm Maximum over 0°C to +70°C  
 E=±25ppm Maximum over 0°C to +70°C  
 F=±20ppm Maximum over 0°C to +70°C  
 G=±100ppm Maximum over -40°C to +85°C  
 H=±50ppm Maximum over -40°C to +85°C

#### DUTY CYCLE

1=50% ±10%, 2=50% ±5%

#### AVAILABLE OPTIONS

Blank= Tubes  
 TR= Tape and Reel (Standard)

#### FREQUENCY

#### LOGIC CONTROL/ADDITIONAL OUTPUT

A= No Connect  
 B= Enable/Disable  
 C= Complementary Output

#### MECHANICAL DIMENSIONS ALL DIMENSIONS IN MILLIMETERS

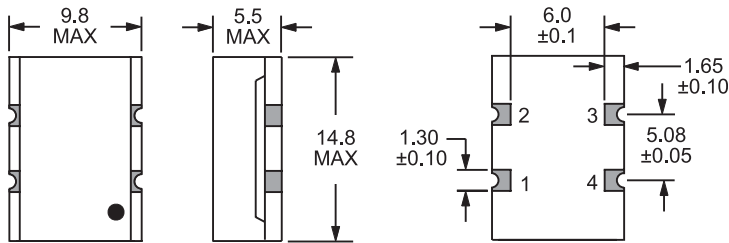

Pin 1: Complementary Output, No Connect, or Enable/Disable  
 Pin 2: Case Ground Pin 3: Output Pin 4: Supply Voltage

#### SUGGESTED SOLDER PAD LAYOUT ALL DIMENSIONS IN MILLIMETERS

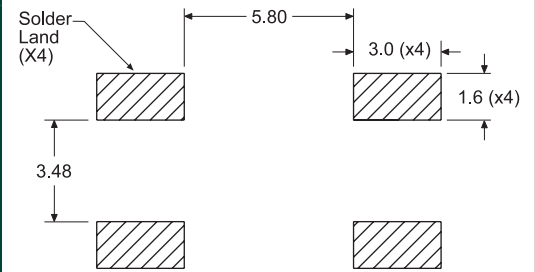

#### TAPE AND REEL DIMENSIONS ALL DIMENSIONS IN MILLIMETERS

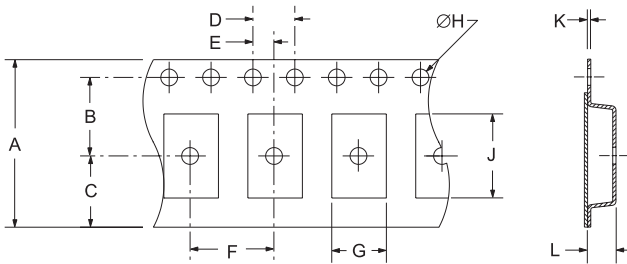

TAPE	A	B	C	D	E
	24 ±.3	11.5 ±.1	10.75 ±.1	4 ±.2	2 ±.1
F	G	H	J	K	L
	B0*	1.5 +.1-0	A0*	.4 ±.05	K0*

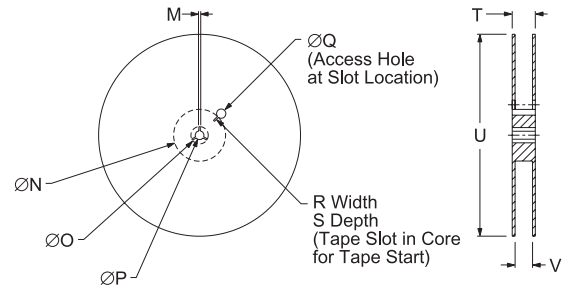

REEL	M	N	O	P	Q	
	1.5 MIN	50 MIN	20.2 MIN	13 ±.2	40 MIN	
R	S	T	U	V	QTY/REEL	
	2.5 MIN	10 MIN	30.4 MAX	360 MAX	24.4+2-0	1000

\*Compliant to EIA 481A

#### ENVIRONMENTAL/MECHANICAL SPECIFICATIONS

Characteristic	Specification
Fine Leak Test	MIL-STD-883, Method 1014, Condition A
Gross Leak Test	MIL-STD-883, Method 1014, Condition C
Mechanical Shock	MIL-STD-202, Method 213, Condition C
Vibration	MIL-STD-883, Method 2007, Condition A
Solderability	MIL-STD-883, Method 2002
Temperature Cycling	MIL-STD-883, Method 1010
Resistance to Soldering Heat	MIL-STD-202, Method 210
Resistance to Solvents	MIL-STD-202, Method 215

#### MARKING SPECIFICATIONS

Line 1: ECLIPTEK  
 Line 2: XX.XXX M  
 Frequency in MHz (5 Digits Maximum + Decimal)  
 Line 3: XX Y ZZ  
 Week of Year  
 Last Digit of Year  
 Ecliptek Manufacturing Identifier

# OBSOLETE

MIL-STD-883C	ECLIPTEK CORP.	OSCILLATOR	E11W1	PACKAGE 4-PCB	VOLTAGE 5.0V	CLASS OS77	REV. DATE 01/03
--------------	----------------	------------	-------	------------------	-----------------	---------------	--------------------

# E13W1 Series

- PECL Output Oscillators
- 3.3V supply voltage
- 4 pad PCB SMD package
- Stability to 20ppm
- Output Enable/Disable available
- Complementary Output available
- Available on Tape and Reel

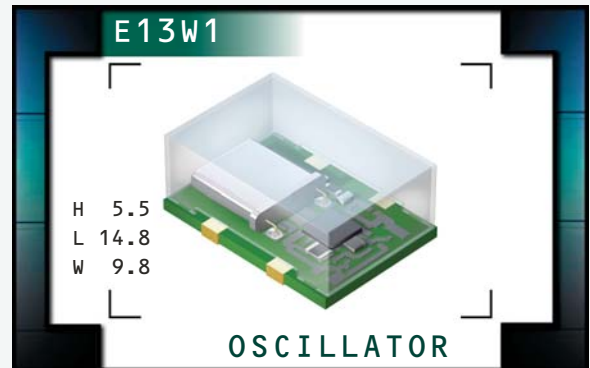

## NOTES

OBSOLETE

### ELECTRICAL SPECIFICATIONS

<b>Frequency Range</b>		19.440MHz to 250.000MHz
<b>Operating Temperature Range</b>		0°C to 70°C
	Available at Frequencies $\leq$ 212.500MHz	-40°C to 85°C
<b>Storage Temperature Range</b>		-55°C to 125°C
<b>Supply Voltage (<math>V_{CC}</math>)</b>		3.3V <sub>DC</sub> $\pm$ 5%
<b>Input Current</b>		75mA Maximum
<b>Logic Type</b>		100KH
<b>Frequency Tolerance / Stability</b>	Inclusive of all conditions: Calibration Tolerance at 25°C, Frequency Stability over the Operating Temperature Range, Supply Voltage Change, Output Load Change, Aging, Shock, and Vibration	$\pm$ 100ppm, $\pm$ 50ppm, $\pm$ 25ppm, or $\pm$ 20ppm Maximum
<b>Output Voltage Logic High (<math>V_{OH}</math>)</b>		$V_{CC}$ -1.025V <sub>DC</sub> Minimum
<b>Output Voltage Logic Low (<math>V_{OL}</math>)</b>		$V_{CC}$ -1.620V <sub>DC</sub> Maximum
<b>Rise Time / Fall Time</b>	20% to 80% of waveform	2 nSeconds Maximum
<b>Duty Cycle</b>	at 50% of waveform	50 $\pm$ 10(%) 50 $\pm$ 5(%)
<b>Load Drive Capability</b>		50 Ohms into $V_{CC}$ -2.0V <sub>DC</sub>
<b>Logic Control / Additional Output</b>		No Connect, Enable/Disable, or Complementary Output
<b>Enable/Disable Input Voltage</b>	$V_{IL}$ of $V_{CC}$ -1.475V <sub>DC</sub> Maximum No Connection $V_{IH}$ of $V_{CC}$ -1.165V <sub>DC</sub> Minimum	Enables Output Enables Output Disable Output: Logic Low
<b>Start Up Time</b>		10 mSeconds Maximum
<b>RMS Phase Jitter</b>	FJ = 12kHz to 20MHz	1 pSec Maximum

MANUFACTURER ECLIPTEK CORP.	CATEGORY OSCILLATOR	SERIES E13W1	PACKAGE 4-PCB	VOLTAGE 3.3V	CLASS OS75	REV. DATE 01/03
--------------------------------	------------------------	-----------------	------------------	-----------------	---------------	--------------------

# PART NUMBERING GUIDE

## E13W1 F 2 C - 155.520M TR

### FREQUENCY TOLERANCE & STABILITY/ OPERATING TEMPERATURE RANGE

C=±100ppm Maximum over 0°C to +70°C  
 D=±50ppm Maximum over 0°C to +70°C  
 E=±25ppm Maximum over 0°C to +70°C  
 F=±20ppm Maximum over 0°C to +70°C  
 G=±100ppm Maximum over -40°C to +85°C  
 H=±50ppm Maximum over -40°C to +85°C

### DUTY CYCLE

1=50% ±10%, 2=50% ±5%

### AVAILABLE OPTIONS

Blank=Tubes  
 TR=Tape and Reel (Standard)

### FREQUENCY

### LOGIC CONTROL/ADDITIONAL OUTPUT

A=No Connect  
 B=Enable/Disable  
 C=Complementary Output

### MECHANICAL DIMENSIONS ALL DIMENSIONS IN MILLIMETERS

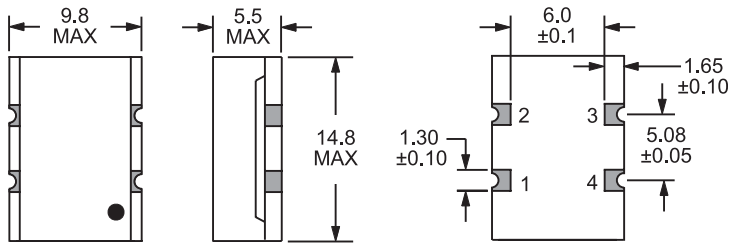

Pin 1: Complementary Output, No Connect, or Enable/Disable  
 Pin 2: Case Ground Pin 3: Output Pin 4: Supply Voltage

### SUGGESTED SOLDER PAD LAYOUT ALL DIMENSIONS IN MILLIMETERS

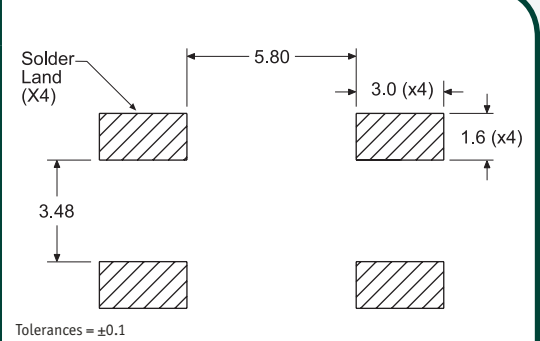

### TAPE AND REEL DIMENSIONS ALL DIMENSIONS IN MILLIMETERS

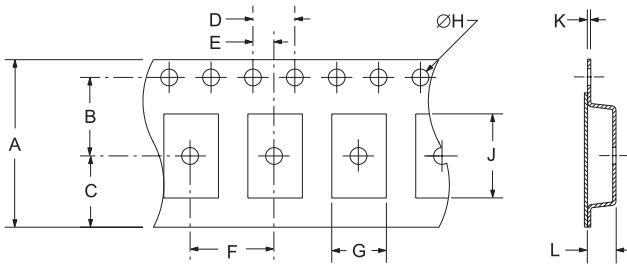

TAPE	A	B	C	D	E
	24 ±.3	11.5 ±.1	10.75 ±.1	4 ±.2	2 ±.1
F	G	H	J	K	L
12 ±.1	B0*	1.5 +.1-0	A0*	.4 ±.05	K0*

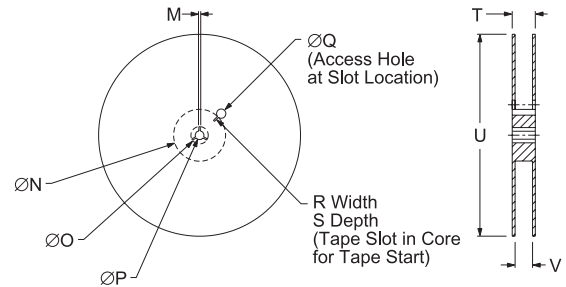

REEL	M	N	O	P	Q
	1.5 MIN	50 MIN	20.2 MIN	13 ±.2	40 MIN
R	S	T	U	V	QTY/REEL
2.5 MIN	10 MIN	30.4 MAX	360 MAX	24.4+2-0	1000

\*Compliant to EIA 481A

### ENVIRONMENTAL/MECHANICAL SPECIFICATIONS

Characteristic	Specification
Fine Leak Test	MIL-STD-883, Method 1014, Condition A
Gross Leak Test	MIL-STD-883, Method 1014, Condition C
Mechanical Shock	MIL-STD-202, Method 213, Condition C
Vibration	MIL-STD-883, Method 2007, Condition A
Solderability	MIL-STD-883, Method 2002
Temperature Cycling	MIL-STD-883, Method 1010
Resistance to Soldering Heat	MIL-STD-202, Method 210
Resistance to Solvents	MIL-STD-202, Method 215

### MARKING SPECIFICATIONS

Line 1: ECLIPTEK  
 Line 2: XX.XXX M  
 Frequency in MHz (5 Digits Maximum + Decimal)  
 Line 3: XX Y ZZ  
 Week of Year  
 Last Digit of Year  
 Ecliptek Manufacturing Identifier

**OBSOLETE**

MANUFACTURER ECLIPTEK CORP.	PACKAGE OSCILLATOR	PART NUMBER E13W1	PACKAGE 4-PCB	VOLTAGE 3.3V	CLASS OS75	REV. DATE 01/03
--------------------------------	-----------------------	----------------------	------------------	-----------------	---------------	--------------------