

FIBER COUPLED LASER MODULE (375 NM)

FCLM375 Series

The FCLM™ Laser Module is a temperature stabilized semiconductor laser coupled with single mode fiber. It features very low M² value Gaussian beam output with excellent beam pointing stability at a wide temperature dynamic range. The unique designed electrical driver enable this optical engine has the lowest power consumptions compare to the similar product in the industry. The FCLM™ Laser Module is a Class III b laser product

Performance Specification

| | Condition | Min | Typ | Max | Unit |
|-----------------------------------|------------------|------------------------------|-----------------|-----|---------|
| Optical Performance | | | | | |
| Wavelength | T= 25°C | | 375 | | nm |
| Output Power | T= 25°C | | 8 | | mW |
| Noise(RMS) | 10~20 MHz | | 0.1 | 0.3 | % |
| Power Stability | 1hrs, T= 25°C | | 0.25 | 0.5 | % |
| Power Stability | 24hrs, T= 25°C | | 0.75 | 1 | % |
| Polarization Extinction Ratio | | 15 | | | dB |
| Collimated Beam Parameters | | | | | |
| M2 | | | | 1.2 | |
| Beam Diameter | 1/e ² | 0.7, 0.9, 1.5, 2.0, 4.0, 6.0 | | | mm |
| Beam Divergence | full angle | | | 1 | mrad |
| Pointing Stability | 2hrs, T= 25°C | | | 5 | urad |
| Pointing Stability | | | | 1 | urad/°C |
| Fiber Information | | | | | |
| Length | | | 1, 2, 3 | | m |
| Fiber Type | | | SM / PM | | |
| Mode Field Diameter | | | 3 | | um |
| NA | | | 0.12 | | |
| Fiber Jacket Diameter | | | 3 | | mm |
| Electrical Parameters | | | | | |
| Power Supply | | | 9 | | V |
| Power Consumption | | | 3 | 10 | W |
| Current(TEC) | | | | 2 | A |
| Current(LD) | | | | 200 | mA |
| Temperature Stability | | | 0.2 | | °C |
| Control | | | ACC | | |
| Power Setting | | 0% ~ 100% output power | | | |
| Environmental Conditions | | | | | |
| Storage Temperature | | | 0 to + 50 | | °C |
| Operation Temperature | | | + 10 to + 40 | | °C |
| Operation Humidity | | | No Condensing | | |
| Package Dimensions * | | | 112 x 56 x 26.5 | | mm |

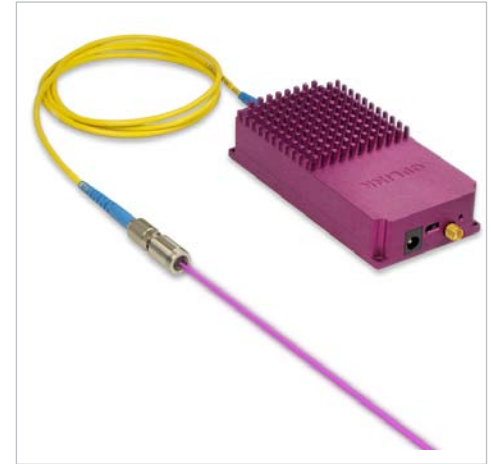

Features

- ◆ Plug & Play
- ◆ ESD Protection
- ◆ Power Adjustable
- ◆ LD Current Full Protection
- ◆ LD Temperature Stabilized
- ◆ Compact Size

Applications

- ◆ Polarization Maintaining Fiber
- ◆ High Speed Modulation
- ◆ Remote Control
- ◆ Collimated & Focused Beam
- ◆ Metal Jacket Protection

Note:

* The mechanical tolerance should be +/-0.2 mm on all package dimensions unless otherwise custom specified.

FCLM375 SERIES

Mechanical Drawing / Package Dimensions (dimension in mm)

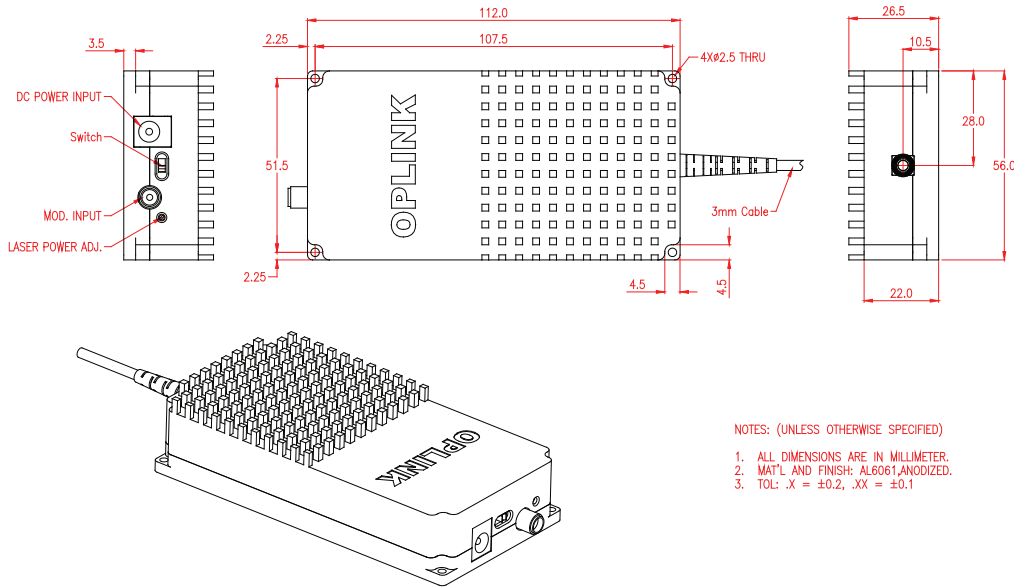

Ordering Information

Oplink can provide a remarkable range of customized optical solutions. For detail, please contact Oplink's OEM design team or account manager for your requirements and ordering information (510) 933-7200.

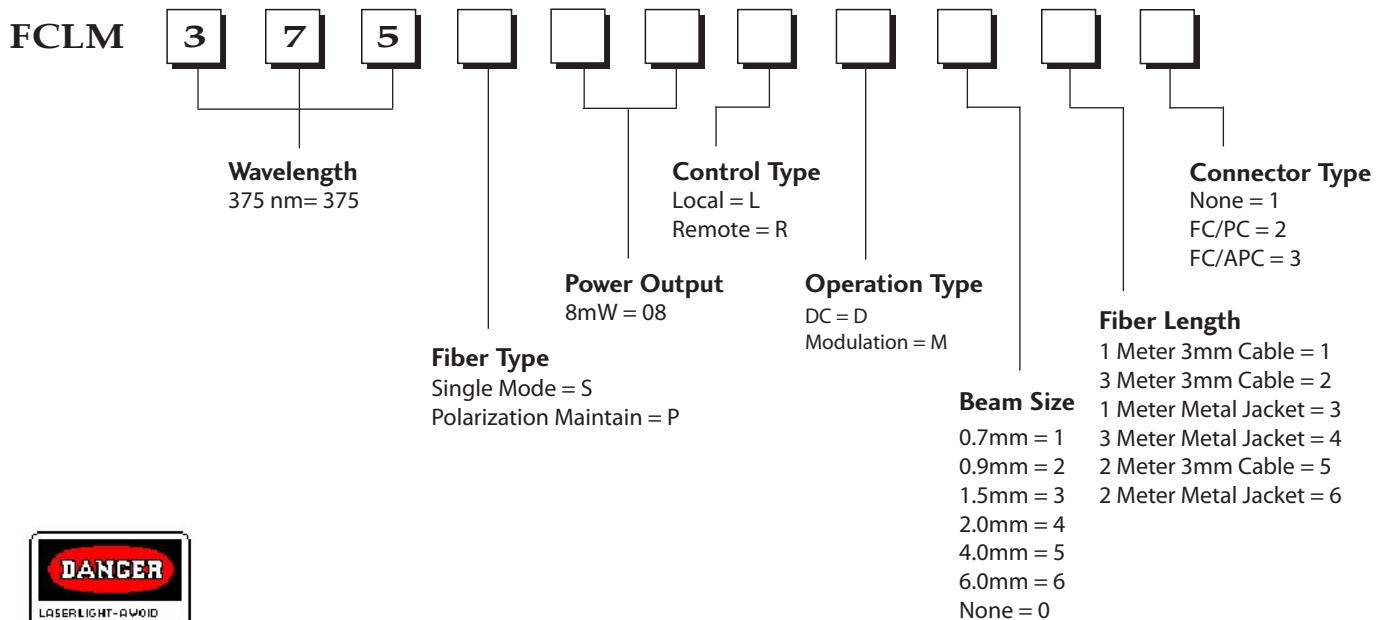

This component does not comply with the Federal Regulations (21 CFR Subchapter 1) as administered by the Center for Devices and Radiological health. Purchaser acknowledges that his/her products must comply with these regulations before they can be sold to a customer. The output light from this product is harmful to a human body even if it is invisible. Avoid looking at the output of this product directly, or through a lens during operation. Observance of operation should be through a TV camera or related equipment. Refer to IEC 825-1 and 21 CFR 1040.10-1040.11 as a radiation safety standard for laser products.

Oplink follows a policy of continuous product improvement. Specifications are subject to change without prior notice. The module's warranty is 1 year.

R04.20090331