



FEATURES

- 20 WATTS OUTPUT POWER
- OUTPUT CURRENT UP TO 4A
- STANDARD 2" X 1.6" X 0.4" PACKAGE
- HIGH EFFICIENCY UP TO 87%
- 2:1 AND 4:1 WIDE INPUT VOLTAGE RANGE
- SIX-SIDED CONTINUOUS SHIELD
- FIXED SWITCHING FREQUENCY
- CE MARK MEETS 2006/95/EC, 93/68/EEC AND 2004/108/EC
- UL60950-1, EN60950-1 AND IEC60950-1 LICENSED
- ISO9001 CERTIFIED MANUFACTURING FACILITIES
- COMPLIANT TO RoHS EU DIRECTIVE 2002/95/EC

APPLICATIONS

Wireless Network
Telecom/Datacom
Industry Control System
Measurement Equipment
Semiconductor Equipment

DESCRIPTION

The FDC20 and FDC20-W series offer 20 Watts of output power from a 2 x 1.6 x 0.4 inch package. The FDC20 series with 2:1 wide input voltage of 9-18, 18-36 and 36-75VDC. The FDC20-W series with 4:1 wide input voltage of 9-36 and 18-75VDC.

TECHNICAL SPECIFICATION All specifications are typical at nominal input, full load and 25°C otherwise noted

OUTPUT SPECIFICATIONS			
Output power	20 Watts, max.		
Voltage accuracy	Full load and nominal Vin	Single & Dual	± 1%
		Triple 3.3V/5V	± 1%
		Auxiliary	± 5%
		Minimum load (Note 6)	
Voltage adjustability	± 10%		
Line regulation	LL to HL at Full Load	Single (W)	± 0.2%
		Dual (W)	± 0.5%
		Triple 3.3V/5V	± 1%
		Auxiliary	± 5%
Load regulation	Min. Load to Full Load	Single	± 0.5%
		Dual	± 3%
		Triple 3.3V/5V	± 2%
		Auxiliary	± 5%
Cross regulation (Note 7)	Dual	Triple 3.3V/5V	± 2%
		Auxiliary	± 5%
		Ripple and noise	20MHz bandwidth
Temperature coefficient	±0.02% / °C, max.		
Transient response recovery time	25% load step change	Single	250µS
		Dual	250µS
		Triple	500µS
Over voltage protection	3.3V output	3.9VDC	
	5V output	6.2VDC	
Zener diode clamp	12V output	15VDC	
	15V output	18VDC	
	Over load protection	% of FL at nominal input	150%, max.
Short circuit protection	Hiccup, automatics recovery		
GENERAL SPECIFICATIONS			
Efficiency	See table		
Isolation voltage	1600VDC, min.		
Isolation resistance	10 ⁹ ohms, min.		
Isolation capacitance	300pF, max.		
Switching frequency	300KHz, typ.		
Approvals and standard	IEC60950-1, UL60950-1, EN60950-1		
Case material	Nickel-coated copper		
Base material	Non-conductive black plastic		
Potting material	Epoxy (UL94-V0)		
Dimensions	2.00 X 1.60 X 0.40 Inch (50.8 X 40.6 X 10.2 mm)		
Weight	48g (1.69oz)		
MTBF (Note 1)	BELLCORE TR-NWT-000332	1.928 x 10 ⁶ hrs	
	MIL-HDBK-217F	7.650 x 10 ⁵ hrs	

INPUT SPECIFICATIONS			
Input voltage range	FDC20	12V nominal input	9 – 18VDC
		24V nominal input	18 – 36VDC
		48V nominal input	36 – 75VDC
	FDC20-W	24V nominal input	9 – 36VDC
		48V nominal input	18 – 75VDC
Input filter	Pi type		
Input surge voltage	12V input	36VDC	
	24V input	50VDC	
	100mS max	48V input	100VDC
Input reflected ripple current	Nominal Vin and full load		25mA _{p-p}
Start up time	Nominal Vin and constant resistive load	Power up	20mS, typ.
	Remote ON/OFF (Note 8)		
(Positive logic)	DC-DC ON	Open or 3.5V < Vr < 12V	
	DC-DC OFF	Short or 0V < Vr < 1.2V	
Input current of remote control pin	Nominal Vin	-0.5~1.0mA	
Remote off state input current	Nominal Vin	20mA	
ENVIRONMENTAL SPECIFICATIONS			
Operating ambient temperature	-40°C ~ +85°C (with derating)		
Maximum case temperature	+100°C		
Storage temperature range	-55°C ~ +105°C		
Thermal impedance (Note 9)	Nature convection	10°C/watt	
	Nature convection with heat-sink	8.24°C/watt	
Thermal shock	MIL-STD-810F		
Vibration	MIL-STD-810F		
Relative humidity	5% to 95% RH		
EMC CHARACTERISTICS			
EMI (Note 10)	EN55022	Class A	
ESD	EN61000-4-2	Air	± 8KV
		Contact	± 6KV
Radiated immunity	EN61000-4-3	10 V/m	Perf. Criteria A
Fast transient (Note 11)	EN61000-4-4	± 2KV	Perf. Criteria B
Surge (Note 11)	EN61000-4-5	± 1KV	Perf. Criteria B
Conducted immunity	EN61000-4-6	10 V _{r.m.s}	Perf. Criteria A

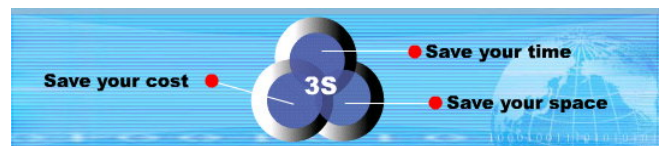



Model Number	Input Range	Output Voltage	Output Current		Output ⁽⁴⁾ Ripple & Noise	Input Current		Eff ⁽⁴⁾ (%)	Capacitor ⁽⁵⁾ Load max
			Min. load	Full load		No load ⁽³⁾	Full load ⁽²⁾		
FDC20-12S33	9 – 18 VDC	3.3 VDC	280mA	4000mA	75mVp-p	40mA	1507mA	77	13000μF
FDC20-12S05	9 – 18 VDC	5 VDC	280mA	4000mA	75mVp-p	15mA	2193mA	80	6800μF
FDC20-12S12	9 – 18 VDC	12 VDC	134mA	1670mA	75mVp-p	40mA	2110mA	83	2200μF
FDC20-12S15	9 – 18 VDC	15 VDC	106mA	1330mA	75mVp-p	20mA	2083mA	84	755μF
FDC20-12D05	9 – 18 VDC	± 5 VDC	± 140mA	± 2000mA	100mVp-p	15mA	2136mA	82	± 3400μF
FDC20-12D12	9 – 18 VDC	± 12 VDC	± 67mA	± 833mA	100mVp-p	35mA	2110mA	83	± 680μF
FDC20-12D15	9 – 18 VDC	± 15 VDC	± 53mA	± 666mA	100mVp-p	35mA	2110mA	83	± 450μF
FDC20-12T3312	9 – 18 VDC	3.3 / ± 12 VDC	300 / ± 30mA	3000 / ± 300mA	50 / ± 120mVp-p	20mA	1900mA	79	4700 / ± 220μF
FDC20-12T3315	9 – 18 VDC	3.3 / ± 15 VDC	300 / ± 25mA	3000 / ± 250mA	50 / ± 150mVp-p	35mA	1933mA	79	4700 / ± 220μF
FDC20-12T0512	9 – 18 VDC	5 / ± 12 VDC	200 / ± 30mA	2000 / ± 300mA	50 / ± 120mVp-p	20mA	1885mA	80	4700 / ± 220μF
FDC20-12T0515	9 – 18 VDC	5 / ± 15 VDC	200 / ± 25mA	2000 / ± 250mA	50 / ± 150mVp-p	40mA	1919mA	80	4700 / ± 220μF
FDC20-24S33 (W)	18 – 36 (9 – 36) VDC	3.3 VDC	280mA	4000mA	75mVp-p	10(20)mA	733 (764mA)	79 (76)	13000μF
FDC20-24S05 (W)	18 – 36 (9 – 36) VDC	5 VDC	280mA	4000mA	75mVp-p	10(10)mA	1082 (1111mA)	81 (79)	6800μF
FDC20-24S12 (W)	18 – 36 (9 – 36) VDC	12 VDC	134mA	1670mA	75mVp-p	10(20)mA	1018 (1082mA)	86 (81)	2200μF
FDC20-24S15 (W)	18 – 36 (9 – 36) VDC	15 VDC	106mA	1330mA	75mVp-p	15(20)mA	1018 (1082mA)	86 (81)	755μF
FDC20-24D05 (W)	18 – 36 (9 – 36) VDC	± 5 VDC	± 140mA	± 2000mA	100mVp-p	20(15)mA	1028 (1111mA)	85 (79)	± 3400μF
FDC20-24D12 (W)	18 – 36 (9 – 36) VDC	± 12 VDC	± 67mA	± 833mA	100mVp-p	25(20)mA	1016 (1068mA)	86 (82)	± 680μF
FDC20-24D15 (W)	18 – 36 (9 – 36) VDC	± 15 VDC	± 53mA	± 666mA	100mVp-p	30(25)mA	1015 (1068mA)	86 (82)	± 450μF
FDC20-24T3312	18 – 36 VDC	3.3 / ± 12 VDC	300 / ± 30mA	3000 / ± 300mA	50 / ± 120mVp-p	20mA	914mA	82	4700 / ± 220μF
FDC20-24T3315	18 – 36 VDC	3.3 / ± 15 VDC	300 / ± 25mA	3000 / ± 250mA	50 / ± 150mVp-p	20mA	967mA	79	4700 / ± 220μF
FDC20-24T0512	18 – 36 VDC	5 / ± 12 VDC	200 / ± 30mA	2000 / ± 300mA	50 / ± 120mVp-p	25mA	907mA	83	4700 / ± 220μF
FDC20-24T0515	18 – 36 VDC	5 / ± 15 VDC	200 / ± 25mA	2000 / ± 250mA	50 / ± 150mVp-p	10mA	922mA	83	4700 / ± 220μF
FDC20-48S33 (W)	36 – 75 (18 – 75) VDC	3.3 VDC	280mA	4000mA	75mVp-p	10(15)mA	367 (377mA)	79 (77)	13000μF
FDC20-48S05 (W)	36 – 75 (18 – 75) VDC	5 VDC	280mA	4000mA	75mVp-p	10(10)mA	543 (548mA)	82 (80)	6800μF
FDC20-48S12 (W)	36 – 75 (18 – 75) VDC	12 VDC	134mA	1670mA	75mVp-p	15(10)mA	509 (536mA)	86 (82)	2200μF
FDC20-48S15 (W)	36 – 75 (18 – 75) VDC	15 VDC	106mA	1330mA	75mVp-p	25(10)mA	506 (532mA)	86 (82)	755μF
FDC20-48D05 (W)	36 – 75 (18 – 75) VDC	± 5 VDC	± 140mA	± 2000mA	100mVp-p	15(10)mA	514 (541mA)	85 (81)	± 3400μF
FDC20-48D12 (W)	36 – 75 (18 – 75) VDC	± 12 VDC	± 67mA	± 833mA	100mVp-p	15(15)mA	502 (527mA)	87 (83)	± 680μF
FDC20-48D15 (W)	36 – 75 (18 – 75) VDC	± 15 VDC	± 53mA	± 666mA	100mVp-p	20(20)mA	502 (527mA)	87 (83)	± 450μF
FDC20-48T3312	36 – 75 VDC	3.3 / ± 12 VDC	300 / ± 30mA	3000 / ± 300mA	50 / ± 120mVp-p	10mA	457mA	82	4700 / ± 220μF
FDC20-48T3315	36 – 75 VDC	3.3 / ± 15 VDC	300 / ± 25mA	3000 / ± 250mA	50 / ± 150mVp-p	10mA	464mA	82	4700 / ± 220μF
FDC20-48T0512	36 – 75 VDC	5 / ± 12 VDC	200 / ± 30mA	2000 / ± 300mA	50 / ± 120mVp-p	15mA	448mA	84	4700 / ± 220μF
FDC20-48T0515	36 – 75 VDC	5 / ± 15 VDC	200 / ± 25mA	2000 / ± 250mA	50 / ± 150mVp-p	15mA	456mA	84	4700 / ± 220μF

⁽¹²⁾FDC20-24D3305 and FDC20-48D3305, Output 3.3V(3A)/5V(2A), Detail Spec. Contact Factory.

Note

- BELLCORE TR-NWT-000332. Case 1: 50% Stress, Temperature at 40°C. MIL-HDBK-217F Notice2 @Ta=25 °C, Full load(Ground, Benign, controlled environment).
- Maximum value at nominal input voltage and full load.
- Typical value at nominal input voltage and no load.
- Typical value at nominal input voltage and full load.
- Test by minimum Vin and constant resistive load.
- The output requires a minimum loading on the output to maintain specified regulation. Operation under no-load condition will not damage these devices, however they may not meet all listed specification.
- Cross regulation : Dual output—Asymmetrical load 25% to 100% full load
Triple output – 3.3V / 5V 100% load and one of auxiliary 100% load, other auxiliary load change from 25% to 100% load
- The ON/OFF control pin voltage is referenced to -Vin
- Heat sink is optional and P/N: 7G-0011C-F and the operation temperature range please see curve.
- The FDC20 series can meet EN55022 Class A with parallel an external capacitor to the input pins.
Recommend: 12Vin : 6.8μF/50V 1812 MLCC . 24Vin : N/A. 48Vin : 2.2μF/100V 1812 MLCC .
- An external input filter capacitor is required if the module has to meet EN61000-4-4, EN61000-4-5.
The filter capacitor Power Mate suggest: Nippon chemi-con KY series, 220 μF/100V, ESR 48mΩ .
- The FDC20-24D3305 and FDC20-48D3305 are safety approval pending.

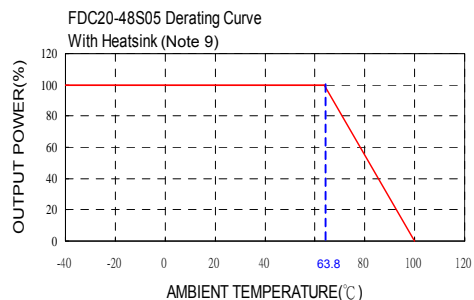
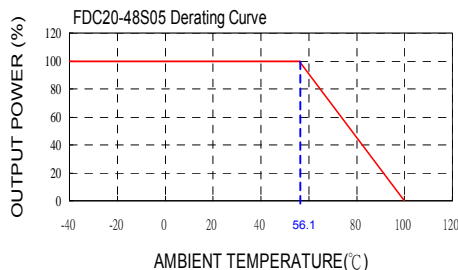

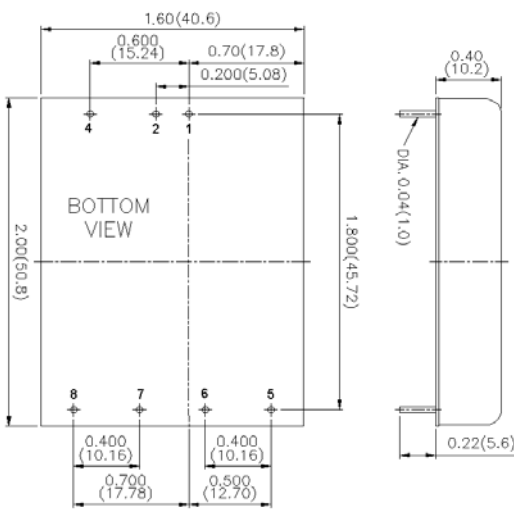
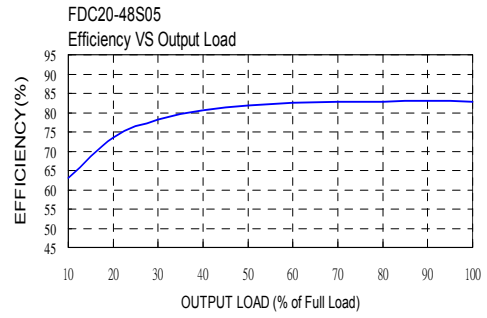
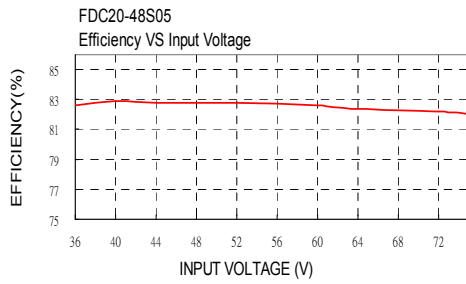

- All dimensions in Inches (mm)
Tolerance: X.XX±0.02 (X.X±0.5)
X.XXX±0.01 (X.XX±0.25)
- Pin pitch tolerance ±0.01(0.25)
- Pin dimension tolerance ±0.004 (0.1)

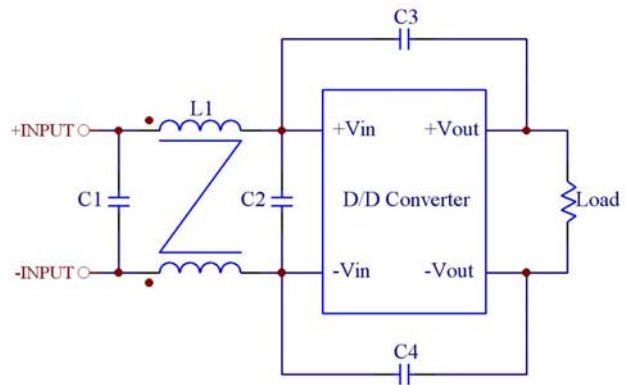

Recommended Filter for EN55022 Class B Compliance

The components used in the above figure, together with the manufacturers' part numbers for these components, are as follows:

	C1	C2	C3	C4	L1
FDC20-12xxx	4.7µF/50V 1812 MLCC	N/A	1000pF/2KV MLCC	1000pF/2KV MLCC	450µH Common Choke PMT-048
FDC20-24xxx	4.7µF/50V 1812 MLCC	N/A	1000pF/2KV MLCC	1000pF/2KV MLCC	450µH Common Choke PMT-048
FDC20-48xxx	2.2µF/100V 1812 MLCC	2.2µF/100V 1812 MLCC	1000pF/2KV MLCC	1000pF/2KV MLCC	450µH Common Choke PMT-048

PIN CONNECTION			
PIN	SINGLE	DUAL	TRIPLE
1	+ INPUT	+ INPUT	+ INPUT
2	- INPUT	- INPUT	- INPUT
4	CTRL	CTRL	CTRL
5	NO PIN	+ OUTPUT	+ AUXILIARY
6	+ OUTPUT	COMMON	+3.3V / +5V
7	- OUTPUT	- OUTPUT	COMMON
8	TRIM	TRIM	- AUXILIARY

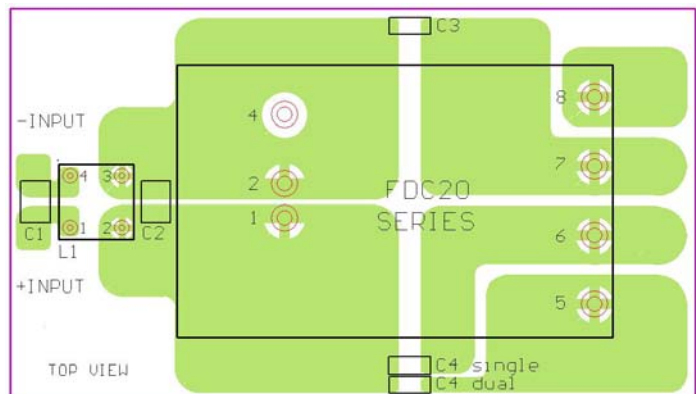
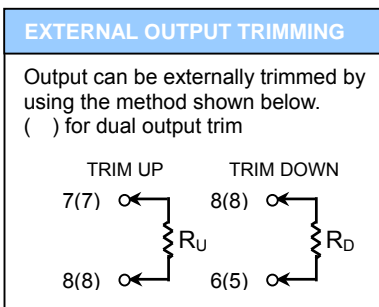

Recommended EN55022 Class B Filter Circuit Layout