

# FIBER COUPLED LASER MODULE (785 NM)

## FCLM785 Series

The FCLM™ Laser Module is a temperature stabilized semiconductor laser coupled with single mode fiber. It features very low M<sup>2</sup> value Gaussian beam output with excellent beam pointing stability at a wide temperature dynamic range. The unique designed electrical driver enable this optical engine has the lowest power consumptions compare to the similar product in the industry. The FCLM™ Laser Module is a Class III b laser product

### Performance Specification

		Condition	Min	Typ	Max	Unit
<b>Optical Performance</b>						
Wavelength		T= 25°C		785		nm
Output Power	15	T= 25°C	15			mW
	50	T= 25°C	50			mW
Noise(RMS)		10~20 MHz		0.1	0.3	%
Power Stability		1hrs, T= 25°C		0.25	0.5	%
Power Stability		24hrs, T= 25°C		0.75	1	%
Polarization Extinction Ratio			15			dB
<b>Collimated Beam Parameters</b>						
M2					1.2	
Beam Diameter		1/e <sup>2</sup>	0.7, 0.9, 1.5, 2.0, 4.0, 6.0			mm
Beam Divergence		full angle			1	mrad
Pointing Stability		2hrs, T= 25°C			5	urad
Pointing Stability					1	urad/°C
<b>Fiber Information</b>						
Length				1, 2, 3		m
Fiber Type				SM / PM		
Mode Field Diameter				3		um
NA				0.12		
Fiber Jacket Diameter				3		mm
<b>Electrical Parameters</b>						
Power Supply				9		V
Power Consumption				3	10	W
Current(TEC)					2	A
Current(LD)					200	mA
Temperature Stability				0.2		°C
Control				ACC		
Power Setting			0% ~ 100% output power			
<b>Environmental Conditions</b>						
Storage Temperature			0 to + 50			°C
Operation Temperature			+ 10 to + 40			°C
Operation Humidity			No Condensing			
Package Dimensions *			112 x 56 x 26.5			mm



### Features

- ◆ Plug & Play
- ◆ ESD Protection
- ◆ Power Adjustable
- ◆ LD Current Full Protection
- ◆ LD Temperature Stabilized
- ◆ Compact Size

### Applications

- ◆ Polarization Maintaining Fiber
- ◆ High Speed Modulation
- ◆ Remote Control
- ◆ Collimated & Focused Beam
- ◆ Metal Jacket Protection

Note:

\* The mechanical tolerance should be +/-0.2 mm on all package dimensions unless otherwise custom specified.

**FCLM658 SERIES**

**Mechanical Drawing / Package Dimensions (dimension in mm)**



- NOTES: (UNLESS OTHERWISE SPECIFIED)
1. ALL DIMENSIONS ARE IN MILLIMETER.
  2. MAT'L AND FINISH: AL6061, ANODIZED.
  3. TOL: .X = ±0.2, .XX = ±0.1

**Ordering Information**

Oplink can provide a remarkable range of customized optical solutions. For detail, please contact Oplink's OEM design team or account manager for your requirements and ordering information (510) 933-7200.

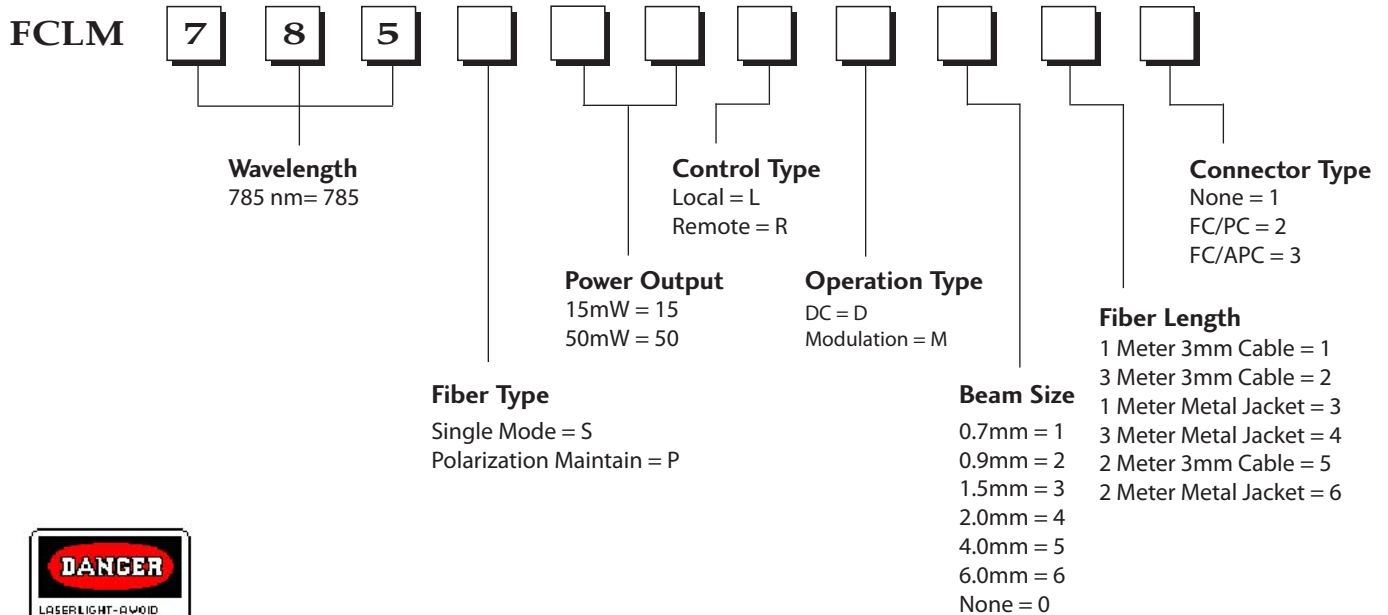

This component does not comply with the Federal Regulations (21 CFR Subchapter1 ) as administered by the Center for Devices and Radiological health. Purchaser acknowledges that his/her products must comply with these regulations before they can be sold to a customer. The output light from this product is harmful to a human body even if it is invisible. Avoid looking at the output of this product directly, or through a lens during operation. Observance of operation should be through a TV camera or related equipment. Refer to IEC 825-1 and 21 CFR 1040.10-1040.11 as a radiation safety standard for laser products.

Oplink follows a policy of continuous product improvement. Specifications are subject to change without prior notice. The module's warranty is 1 year.

R03.20090331