



WBFBP-06C Plastic-Encapsulate Diode

FBAS70DW-04

SURFACE MOUNT SCHOTTKY BARRIER DIODE ARRAYS

DESCRIPTION

Silicon epitaxial planar

PN Junction Guard Ring for Schottky Diode

FEATURES

- Low Forward Voltage Drop
- Fast Switching
- Ultra-Small Surface Mount Package

APPLICATION

For General Purpose Switching Applications, rectifiers

For portable equipment:(i.e. Mobile phone,MP3, MD,CD-ROM, DVD-ROM, Note book PC, etc.)

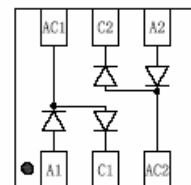

FBAS70DW-04
Marking:K74

Maximum Ratings @ $T_A=25$

Parameter	Symbol	Limits	Unit
Peak Repetitive Peak reverse voltage	V_{RRM}	70	V
Working Peak Reverse Voltage	V_{RWM}		
DC Blocking Voltage	V_R		
Forward Continuous Current	I_F	70	mA
Peak forward surge current @<1.0s	I_{FSM}	100	mA
Power Dissipation	P_d	150	mW
Thermal Resistance Junction to Ambient	$R_{\theta JA}$	625	$^{\circ}C/W$
Junction temperature	T_J	125	$^{\circ}C$
Storage temperature range	T_{STG}	-55 to +125	$^{\circ}C$

Electrical Ratings @ $T_A=25^{\circ}C$

Parameter	Symbol	Min.	Typ.	Max.	Unit	Conditions
Forward voltage	V_{F1}			0.41	V	$I_F=1mA$
	V_{F2}			1	V	$I_F=15mA$
Reverse current	I_R			100	nA	$V_R=50V$
Capacitance between terminals	C_T			2	pF	$V_R=0V, f=1MHz$
Reverse Recovery Time	t_{rr}			5	ns	$I_F=I_R=10mA$ $I_{rr}=0.1X I_R, R_L=100\Omega$

Typical Characteristics

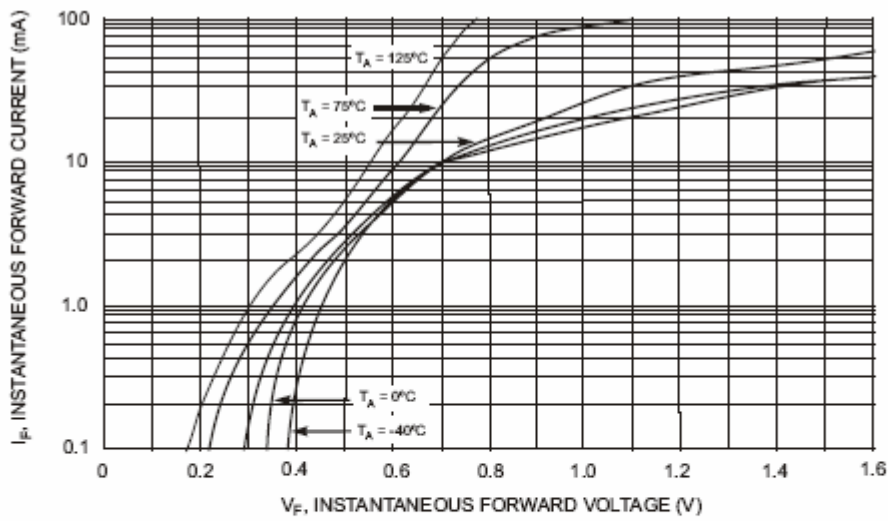

Fig. 1 Typical Forward Characteristics

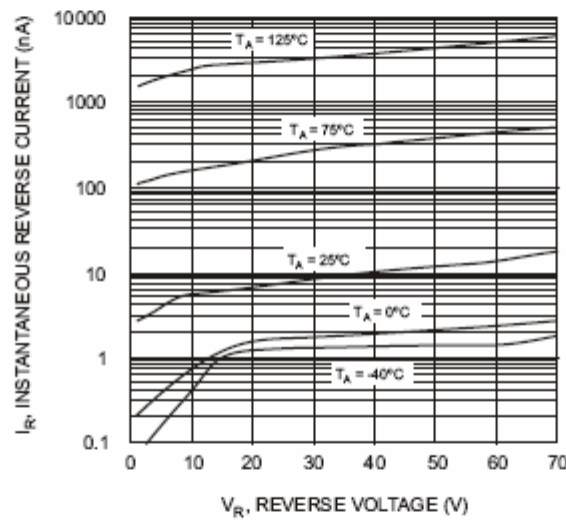

Fig. 2 Typical Reverse Characteristics

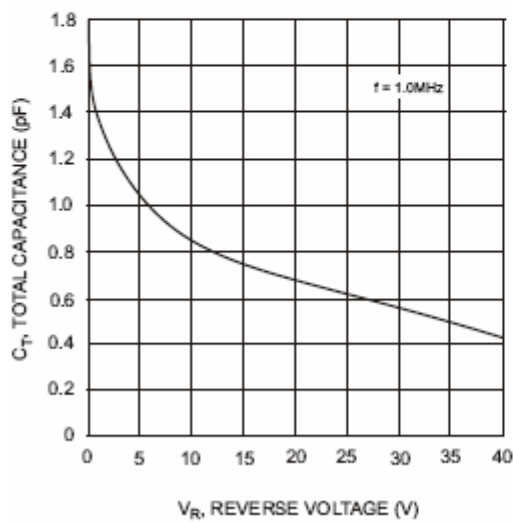

Fig. 3 Typical Capacitance

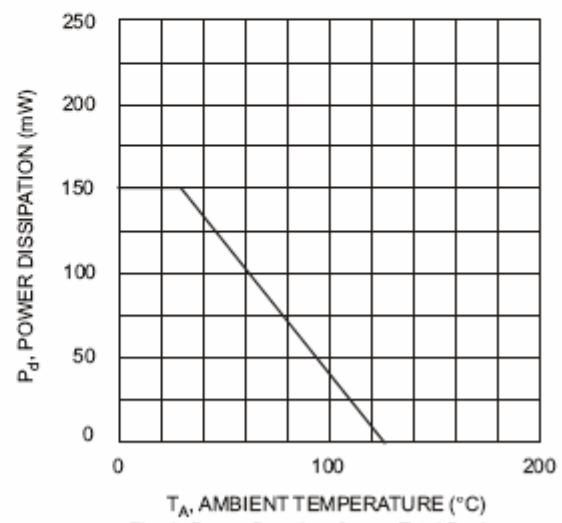
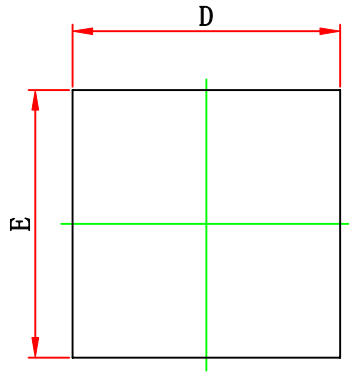

Fig. 4 Power Derating Curve, Total Package



WBFBP-06C(2×2×0.5) PACKAGE OUTLINE DIMENSIONS



TOP VIEW

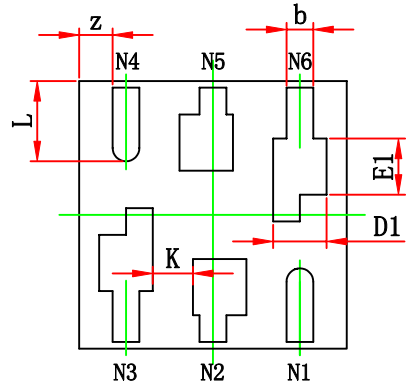

BOTTOM VIEW

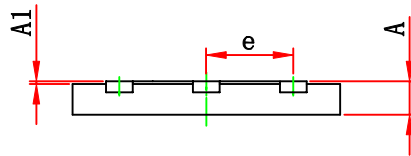

SIDE VIEW

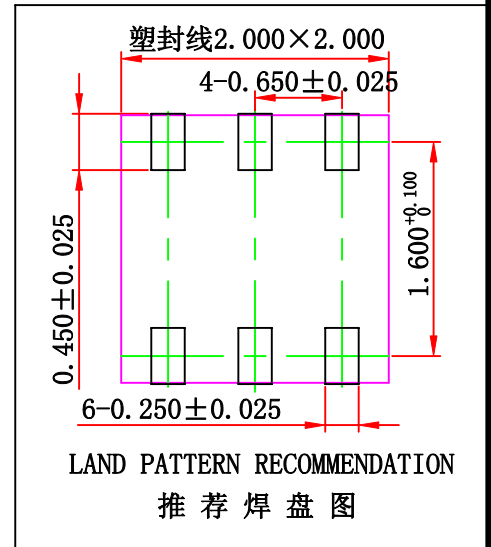

Symbol	Dimensions In Millimeters		Dimensions In Inches	
	Min.	Max.	Min.	Max.
A	0.450	0.550	0.018	0.022
A1	0.000	0.100	0.000	0.004
b	0.150	0.250	0.006	0.010
D	1.900	2.100	0.075	0.083
E	1.900	2.100	0.075	0.083
D1	0.420 REF.		0.017 REF.	
E1	0.420 REF.		0.017 REF.	
e	0.650 TYP.		0.026 TYP.	
L	0.600 REF.		0.024 REF.	
k	0.300 REF.		0.012 REF.	
z	0.500 REF.		0.020 REF.	

APPLICATION CIRCUITS

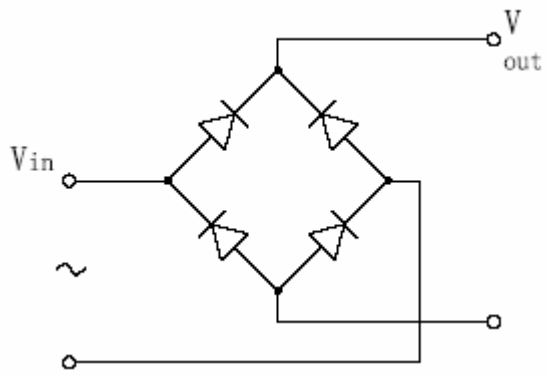

Bridge rectifiers