

**Features**

- $I_{off}$  supports partial-power-down mode operation
- Edge-rate control circuitry for significantly improved noise characteristics
- Typical output skew < 250 ps
- ESD > 2000V
- TSSOP (19.6-mil pitch) and SSOP (25-mil pitch) packages
- Industrial temperature range of  $-40^{\circ}\text{C}$  to  $+85^{\circ}\text{C}$
- $V_{CC} = 5\text{V} \pm 10\%$

*CY74FCT16245T Features:*

- 64 mA sink current, 32 mA source current
- Typical  $V_{OLP}$  (ground bounce) < 1.0V at  $V_{CC} = 5\text{V}$ ,  $T_A = 25^{\circ}\text{C}$

*CY74FCT162245T Features:*

- Balanced output drivers: 24 mA
- Reduced system switching noise
- Typical  $V_{OLP}$  (ground bounce) < 0.6V at  $V_{CC} = 5\text{V}$ ,  $T_A = 25^{\circ}\text{C}$

*CY74FCT162H245T Features:*

- Bus hold on data inputs
- Eliminates the need for external pull-up or pull-down resistors

**Functional Description**

These 16-bit transceivers are designed for use in bidirectional synchronous communication between two buses, where high speed and low power are required. With the exception of the CY74FCT16245T, these devices can be operated either as two independent octals or a single 16-bit transceiver. Direction of data flow is controlled by (DIR), the Output Enable ( $\overline{\text{OE}}$ ) transfers data when LOW and isolates the buses when HIGH.

This device is fully specified for partial-power-down applications using  $I_{off}$ . The  $I_{off}$  circuitry disables the outputs, preventing damaging current backflow through the device when it is powered down.

The CY74FCT16245T is ideally suited for driving high-capacitance loads and low-impedance backplanes.

The CY74FCT162245T has 24-mA balanced output drivers with current limiting resistors in the outputs. This reduces the need for external terminating resistors and provides for minimal undershoot and reduced ground bounce. The CY74FCT162245T is ideal for driving transmission lines.

The CY74FCT162H245T is a 24-mA balanced output part that has bus hold on the data inputs. The device retains the input's last state whenever the input goes to high impedance. This eliminates the need for pull-up/down resistors and prevents floating inputs.

**Logic Block Diagrams CY74FCT16245T, CY74FCT162245T, CY74FCT162H245T**

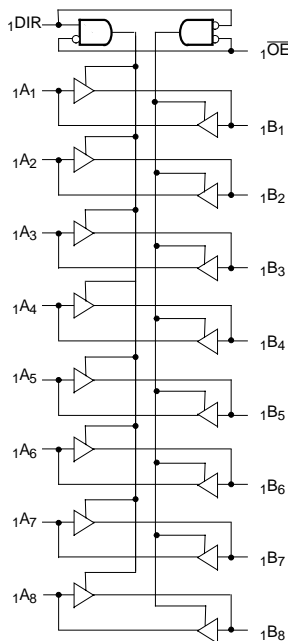

FCT16245-1

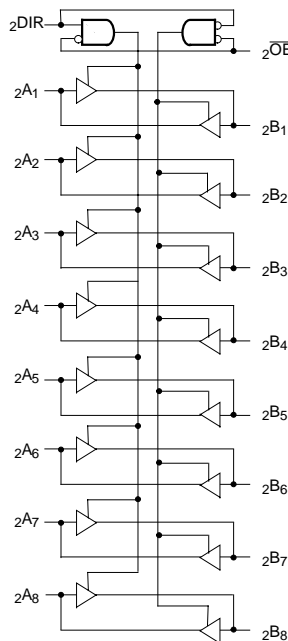

FCT16245-2

**Pin Configuration**

**SSOP/TSSOP Top View**

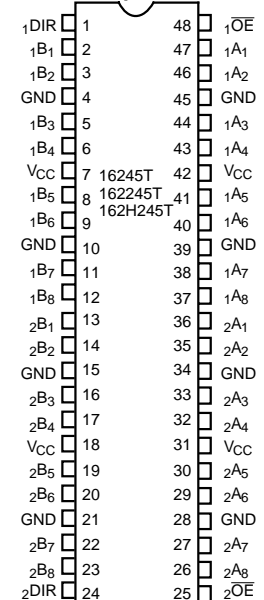

FCT16245-3

### Pin Description

Name	Description
OE	Three-State Output Enable Inputs (Active LOW)
DIR	Direction Control
A	Inputs or Three-State Outputs <sup>[1]</sup>
B	Inputs or Three-State Outputs <sup>[1]</sup>

### Function Table<sup>[2]</sup>

Inputs		Outputs
OE	DIR	
L	L	Bus B Data to Bus A
L	H	Bus A Data to Bus B
H	X	High Z State

### Maximum Ratings<sup>[3, 4]</sup>

(Above which the useful life may be impaired. For user guidelines, not tested.)

Storage Temperature ..... Com'l -55°C to +125°C

Ambient Temperature with Power Applied..... Com'l -55°C to +125°C

DC Input Voltage ..... -0.5V to +7.0V

DC Output Voltage..... -0.5V to +7.0V

DC Output Current (Maximum Sink Current/Pin) ..... -60 to +120 mA

Power Dissipation ..... 1.0W

Static Discharge Voltage..... >2001V (per MIL-STD-883, Method 3015)

### Operating Range

Range	Ambient Temperature	V <sub>CC</sub>
Industrial	-40°C to +85°C	5V ± 10%

#### Notes:

- On CY74FCT162H245T these pins have bus hold.
- H = HIGH Voltage Level. L = LOW Voltage Level. X = Don't Care. Z = High Impedance.
- Operation beyond the limits set forth may impair the useful life of the device. Unless otherwise noted, these limits are over the operating free-air temperature range.
- Unused inputs must always be connected to an appropriate logic voltage level, preferably either V<sub>CC</sub> or ground.

### Electrical Characteristics Over the Operating Range

Parameter	Description	Test Conditions	Min.	Typ. <sup>[5]</sup>	Max.	Unit
V <sub>IH</sub>	Input HIGH Voltage		2.0			V
V <sub>IL</sub>	Input LOW Voltage				0.8	V
V <sub>H</sub>	Input Hysteresis <sup>[6]</sup>			100		mV
V <sub>IK</sub>	Input Clamp Diode Voltage	V <sub>CC</sub> =Min., I <sub>IN</sub> =-18 mA		-0.7	-1.2	V
I <sub>IH</sub>	Input HIGH Current	Standard	V <sub>CC</sub> =Max., V <sub>I</sub> =V <sub>CC</sub>		±1	μA
		Bus Hold			±100	
I <sub>IL</sub>	Input LOW Current	Standard	V <sub>CC</sub> =Max., V <sub>I</sub> =GND		±1	μA
		Bus Hold			±100	μA
I <sub>BH</sub> I <sub>BBL</sub>	Bus Hold Sustain Current on Bus Hold Input <sup>[7]</sup>	V <sub>CC</sub> =Min.	V <sub>I</sub> =2.0V	-50		μA
			V <sub>I</sub> =0.8V	+50		
I <sub>BH</sub> I <sub>BHLO</sub>	Bus Hold Overdrive Current on Bus Hold Input <sup>[7]</sup>	V <sub>CC</sub> =Max., V <sub>I</sub> =1.5V			TBD	mA
I <sub>OZH</sub>	High Impedance Output Current (Three-State Output pins)	V <sub>CC</sub> =Max., V <sub>OUT</sub> =2.7V			±1	μA
I <sub>OZL</sub>	High Impedance Output Current (Three-State Output pins)	V <sub>CC</sub> =Max., V <sub>OUT</sub> =0.5V			±1	μA
I <sub>OS</sub>	Short Circuit Current <sup>[8]</sup>	V <sub>CC</sub> =Max., V <sub>OUT</sub> =GND	-80	-140	-200	mA
I <sub>O</sub>	Output Drive Current <sup>[8]</sup>	V <sub>CC</sub> =Max., V <sub>OUT</sub> =2.5V	-50		-180	mA
I <sub>OFF</sub>	Power-Off Disable	V <sub>CC</sub> =0V, V <sub>OUT</sub> ≤4.5V <sup>[9]</sup>			±1	μA

**Output Drive Characteristics for CY74FCT16245T**

Parameter	Description	Test Conditions	Min.	Typ. <sup>[5]</sup>	Max.	Unit
V <sub>OH</sub>	Output HIGH Voltage	V <sub>CC</sub> =Min., I <sub>OH</sub> =-3 mA	2.5	3.5		V
		V <sub>CC</sub> =Min., I <sub>OH</sub> =-15 mA	2.4	3.5		V
		V <sub>CC</sub> =Min., I <sub>OH</sub> =-32 mA	2.0	3.0		V
V <sub>OL</sub>	Output LOW Voltage	V <sub>CC</sub> =Min., I <sub>OL</sub> =64 mA		0.2	0.55	V

**Output Drive Characteristics for CY74FCT162245T, CY74FCT162H245T**

Parameter	Description	Test Conditions	Min.	Typ. <sup>[5]</sup>	Max.	Unit
I <sub>ODL</sub>	Output LOW Current <sup>[8]</sup>	V <sub>CC</sub> =5V, V <sub>IN</sub> =V <sub>IH</sub> or V <sub>IL</sub> , V <sub>OUT</sub> =1.5V	60	115	150	mA
I <sub>ODH</sub>	Output HIGH Current <sup>[8]</sup>	V <sub>CC</sub> =5V, V <sub>IN</sub> =V <sub>IH</sub> or V <sub>IL</sub> , V <sub>OUT</sub> =1.5V	-60	-115	-150	mA
V <sub>OH</sub>	Output HIGH Voltage	V <sub>CC</sub> =Min., I <sub>OH</sub> =-24 mA	2.4	3.3		V
V <sub>OL</sub>	Output LOW Voltage	V <sub>CC</sub> =Min., I <sub>OL</sub> =24 mA		0.3	0.55	V

**Notes:**

5. Typical values are at V<sub>CC</sub>=5.0V, T<sub>A</sub>=+25°C ambient.
6. This parameter is specified but not tested.
7. Pins with bus hold are described in Pin Description.
8. Not more than one output should be shorted at a time. Duration of short should not exceed one second. The use of high-speed test apparatus and/or sample and hold techniques are preferable in order to minimize internal chip heating and more accurately reflect operational values. Otherwise prolonged shorting of a high output may raise the chip temperature well above normal and thereby cause invalid readings in other parametric tests. In any sequence of parameter tests, I<sub>OS</sub> tests should be performed last.
9. Tested at +25°C.

**Capacitance<sup>[6]</sup> (T<sub>A</sub> = +25°C, f = 1.0 MHz)**

Parameter	Description	Test Conditions	Typ. <sup>[5]</sup>	Max.	Unit
C <sub>IN</sub>	Input Capacitance	V <sub>IN</sub> = 0V	4.5	6.0	pF
C <sub>OUT</sub>	Output Capacitance	V <sub>OUT</sub> = 0V	5.5	8.0	pF

**Power Supply Characteristics**

Parameter	Description	Test Conditions	Typ. <sup>[5]</sup>	Max.	Unit	
$I_{CC}$	Quiescent Power Supply Current	$V_{CC}=\text{Max.}$ $V_{IN}\leq 0.2V$ , $V_{IN}\geq V_{CC}-0.2V$	5	500	$\mu A$	
$\Delta I_{CC}$	Quiescent Power Supply Current (TTL inputs HIGH)	$V_{CC}=\text{Max.}$ $V_{IN}=3.4V^{[10]}$	0.5	1.5	mA	
$I_{CCD}$	Dynamic Power Supply Current <sup>[11]</sup>	$V_{CC}=\text{Max.}$ , One Input Toggling, 50% Duty Cycle, Outputs Open, $OE=DIR=GND$	$V_{IN}=V_{CC}$ or $V_{IN}=GND$	60	100	$\mu A/MHz$
$I_C$	Total Power Supply Current <sup>[12]</sup>	$V_{CC}=\text{Max.}$ , $f_1=10$ MHz, 50% Duty Cycle, Outputs Open, One Bit Toggling, $OE=DIR=GND$	$V_{IN}=V_{CC}$ or $V_{IN}=GND$	0.6	1.5	mA
			$V_{IN}=3.4V$ or $V_{IN}=GND$	0.9	2.3	mA
		$V_{CC}=\text{Max.}$ , $f_1=2.5$ MHz, 50% Duty Cycle, Outputs Open, Sixteen Bits Toggling, $OE=DIR=GND$	$V_{IN}=V_{CC}$ or $V_{IN}=GND$	2.4	4.5 <sup>[13]</sup>	mA
			$V_{IN}=3.4V$ or $V_{IN}=GND$	6.4	16.5 <sup>[13]</sup>	mA

**Notes:**

10. Per TTL driven input ( $V_{IN}=3.4V$ ); all other inputs at  $V_{CC}$  or GND.
11. This parameter is not directly testable, but is derived for use in Total Power Supply calculations.
12.  $I_C = I_{QUIESCENT} + I_{INPUTS} + I_{DYNAMIC}$   
 $I_C = I_{CC} + \Delta I_{CC} D_H N_T + I_{CCD}(f_0/2 + f_1 N_1)$   
 $I_{CC}$  = Quiescent Current with CMOS input levels  
 $\Delta I_{CC}$  = Power Supply Current for a TTL HIGH input ( $V_{IN}=3.4V$ )  
 $D_H$  = Duty Cycle for TTL inputs HIGH  
 $N_T$  = Number of TTL inputs at  $D_H$   
 $I_{CCD}$  = Dynamic Current caused by an input transition pair (HLH or LHL)  
 $f_0$  = Clock frequency for registered devices, otherwise zero  
 $f_1$  = Input signal frequency  
 $N_1$  = Number of inputs changing at  $f_1$   
 All currents are in milliamps and all frequencies are in megahertz.
13. Values for these conditions are examples of the  $I_{CC}$  formula. These limits are specified but not tested.

**Switching Characteristics** Over the Operating Range<sup>[14]</sup>

Parameter	Description	74FCT16245T 74FCT162245T		74FCT16245AT 74FCT162245AT 74FCT162H245AT		Unit	Fig. No. <sup>[15]</sup>
		Min.	Max.	Min.	Max.		
t <sub>PLH</sub> t <sub>PHL</sub>	Propagation Delay Data to Output A to B, B to A	1.5	7.0	1.5	4.5	ns	1, 3
t <sub>PZH</sub> t <sub>PZL</sub>	Output Enable Time OE to A or B	1.5	9.5	1.5	6.2	ns	1, 7, 8
t <sub>PHZ</sub> t <sub>PLZ</sub>	Output Disable Time OE to A or B	1.5	7.5	1.5	5.0	ns	1, 7, 8
t <sub>PZH</sub> t <sub>PZL</sub>	Output Enable Time DIR to A or B	1.5	9.5	1.5	6.2	ns	1, 7, 8
t <sub>PHZ</sub> t <sub>PLZ</sub>	Output Disable Time DIR to A or B	1.5	7.5	1.5	5.0	ns	1, 7, 8
t <sub>SK(O)</sub>	Output Skew <sup>[16]</sup>		0.5		0.5	ns	—

Parameter	Description	74FCT16245CT 74FCT162245CT 74FCT162H245CT		Unit	Fig. No. <sup>[15]</sup>
		Min.	Max.		
t <sub>PLH</sub> t <sub>PHL</sub>	Propagation Delay Data to Output A to B, B to A	1.5	4.1	ns	1, 3
t <sub>PZH</sub> t <sub>PZL</sub>	Output Enable Time OE to A or B	1.5	5.8	ns	1, 7, 8
t <sub>PHZ</sub> t <sub>PLZ</sub>	Output Disable Time OE to A or B	1.5	4.8	ns	1, 7, 8
t <sub>PZH</sub> t <sub>PZL</sub>	Output Enable Time DIR to A or B	1.5	5.8	ns	1, 7, 8
t <sub>PHZ</sub> t <sub>PLZ</sub>	Output Disable Time DIR to A or B	1.5	4.8	ns	1, 7, 8
t <sub>SK(O)</sub>	Output Skew <sup>[16]</sup>		0.5	ns	—

**Note:**

14. Minimum limits are specified but not tested on Propagation Delays.

15. See "Parameter Measurement Information" in the General Information section.

16. Skew between any two outputs of the same package switching in the same direction. This parameter is ensured by design.

**Ordering Information CY74FCT16245**

Speed (ns)	Ordering Code	Package Name	Package Type	Operating Range
4.1	CY74FCT16245CTPACT	Z48	48-Lead (240-Mil) TSSOP	Industrial
	CY74FCT16245CTPVC/PVCT	O48	48-Lead (300-Mil) SSOP	
4.5	CY74FCT16245ATPACT	Z48	48-Lead (240-Mil) TSSOP	Industrial
	CY74FCT16245ATPVC/PVCT	O48	48-Lead (300-Mil) SSOP	
7.0	CY74FCT16245TPACT	Z48	48-Lead (240-Mil) TSSOP	Industrial
	CY74FCT16245TPVC/PVCT	O48	48-Lead (300-Mil) SSOP	

**Ordering Information CY74FCT162245**

Speed (ns)	Ordering Code	Package Name	Package Type	Operating Range
4.1	CY74FCT162245CTPACT	Z48	48-Lead (240-Mil) TSSOP	Industrial
	CY74FCT162245CTPVC	O48	48-Lead (300-Mil) SSOP	
	74FCT162245CTPVCT	O48	48-Lead (300-Mil) SSOP	
4.5	74FCT162245ATPACT	Z48	48-Lead (240-Mil) TSSOP	Industrial
	CY74FCT162245ATPVC	O48	48-Lead (300-Mil) SSOP	
	74FCT162245ATPVCT	O48	48-Lead (300-Mil) SSOP	
7.0	CY74FCT162245TPACT	Z48	48-Lead (240-Mil) TSSOP	Industrial
	CY74FCT162245TPVC/PVCT	O48	48-Lead (300-Mil) SSOP	

**Ordering Information CY74FCT162H245**

Speed (ns)	Ordering Code	Package Name	Package Type	Operating Range
4.1	74FCT162H245CTPACT	Z48	48-Lead (240-Mil) TSSOP	Industrial
	CY74FCT162H245CTPVC	O48	48-Lead (300-Mil) SSOP	
	74FCT162H245CTPVCT	O48	48-Lead (300-Mil) SSOP	
4.5	74FCT162H245ATPACT	Z48	48-Lead (240-Mil) TSSOP	Industrial
	CY74FCT162H245ATPVC	O48	48-Lead (300-Mil) SSOP	
	74FCT162H245ATPVCT	O48	48-Lead (300-Mil) SSOP	

**Package Diagrams**

**48-Lead Shrunk Small Outline Package O48**

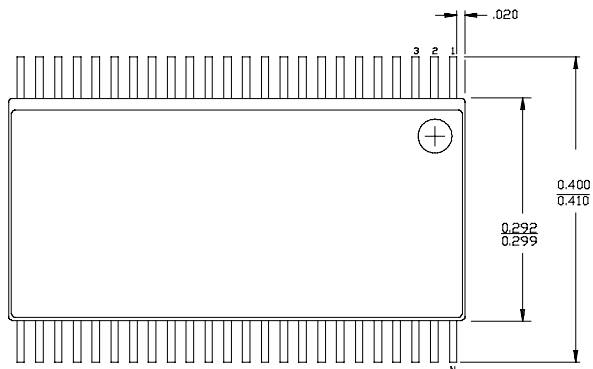

DIMENSIONS IN INCHES MIN.  
MAX.

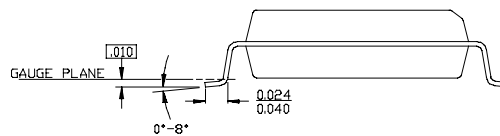
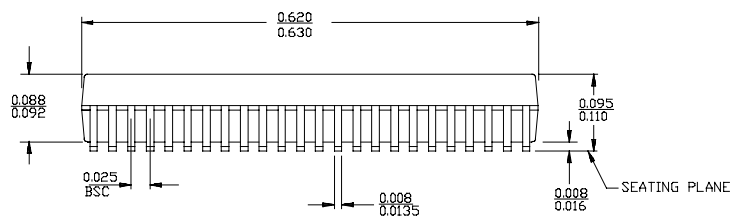

**Package Diagrams**

**48-Lead Thin Shrunk Small Outline Package Z48**

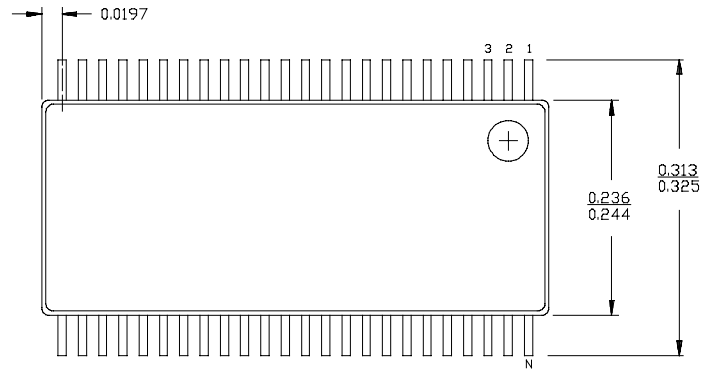

DIMENSIONS IN INCHES MIN.  
MAX.

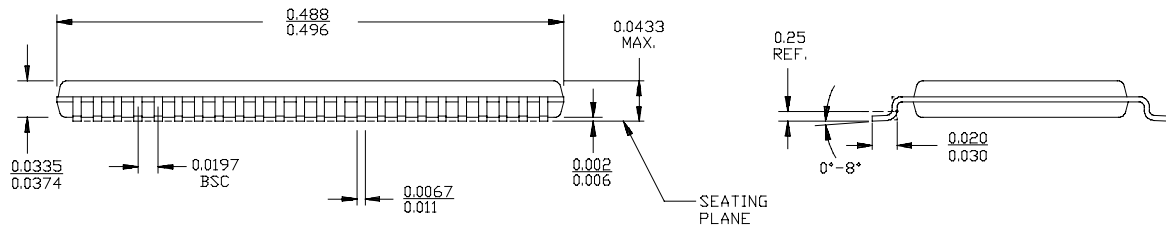



**PACKAGING INFORMATION**

Orderable Device	Status <sup>(1)</sup>	Package Type	Package Drawing	Pins	Package Qty	Eco Plan <sup>(2)</sup>	Lead/Ball Finish	MSL Peak Temp <sup>(3)</sup>
74FCT162245ATPACT	ACTIVE	TSSOP	DGG	48	2000	Green (RoHS & no Sb/Br)	CU NIPDAU	Level-1-260C-UNLIM
74FCT162245ATPVCG4	ACTIVE	SSOP	DL	48	25	Green (RoHS & no Sb/Br)	CU NIPDAU	Level-1-260C-UNLIM
74FCT162245ATPVCT	ACTIVE	SSOP	DL	48	1000	Green (RoHS & no Sb/Br)	CU NIPDAU	Level-1-260C-UNLIM
74FCT162245CTPACT	ACTIVE	TSSOP	DGG	48	2000	Green (RoHS & no Sb/Br)	CU NIPDAU	Level-1-260C-UNLIM
74FCT162245CTPVCG4	ACTIVE	SSOP	DL	48	25	Green (RoHS & no Sb/Br)	CU NIPDAU	Level-1-260C-UNLIM
74FCT162245CTPVCT	ACTIVE	SSOP	DL	48	1000	Green (RoHS & no Sb/Br)	CU NIPDAU	Level-1-260C-UNLIM
74FCT162245ETPACT	OBSOLETE	TSSOP	DGG	48		TBD	Call TI	Call TI
74FCT162245ETPVCT	OBSOLETE	SSOP	DL	48		TBD	Call TI	Call TI
74FCT162245TPACTE4	ACTIVE	TSSOP	DGG	48	2000	Green (RoHS & no Sb/Br)	CU NIPDAU	Level-1-260C-UNLIM
74FCT162245TPACTG4	ACTIVE	TSSOP	DGG	48	2000	Green (RoHS & no Sb/Br)	CU NIPDAU	Level-1-260C-UNLIM
74FCT162245TPVCG4	ACTIVE	SSOP	DL	48	25	Green (RoHS & no Sb/Br)	CU NIPDAU	Level-1-260C-UNLIM
74FCT162245TPVCTG4	ACTIVE	SSOP	DL	48	1000	Green (RoHS & no Sb/Br)	CU NIPDAU	Level-1-260C-UNLIM
74FCT16245ATPACTE4	ACTIVE	TSSOP	DGG	48	2000	Green (RoHS & no Sb/Br)	CU NIPDAU	Level-1-260C-UNLIM
74FCT16245ATPACTG4	ACTIVE	TSSOP	DGG	48	2000	Green (RoHS & no Sb/Br)	CU NIPDAU	Level-1-260C-UNLIM
74FCT16245ATPVCG4	ACTIVE	SSOP	DL	48	25	Green (RoHS & no Sb/Br)	CU NIPDAU	Level-1-260C-UNLIM
74FCT16245ATPVCTG4	ACTIVE	SSOP	DL	48	1000	Green (RoHS & no Sb/Br)	CU NIPDAU	Level-1-260C-UNLIM
74FCT16245CTPACTE4	ACTIVE	TSSOP	DGG	48	2000	Green (RoHS & no Sb/Br)	CU NIPDAU	Level-1-260C-UNLIM
74FCT16245CTPACTG4	ACTIVE	TSSOP	DGG	48	2000	Green (RoHS & no Sb/Br)	CU NIPDAU	Level-1-260C-UNLIM
74FCT16245CTPVCG4	ACTIVE	SSOP	DL	48	25	Green (RoHS & no Sb/Br)	CU NIPDAU	Level-1-260C-UNLIM
74FCT16245CTPVCTG4	ACTIVE	SSOP	DL	48	1000	Green (RoHS & no Sb/Br)	CU NIPDAU	Level-1-260C-UNLIM
74FCT16245TPACTE4	ACTIVE	TSSOP	DGG	48	2000	Green (RoHS & no Sb/Br)	CU NIPDAU	Level-1-260C-UNLIM
74FCT16245TPACTG4	ACTIVE	TSSOP	DGG	48	2000	Green (RoHS & no Sb/Br)	CU NIPDAU	Level-1-260C-UNLIM
74FCT16245TPVCG4	ACTIVE	SSOP	DL	48	25	Green (RoHS & no Sb/Br)	CU NIPDAU	Level-1-260C-UNLIM
74FCT16245TPVCTG4	ACTIVE	SSOP	DL	48	1000	Green (RoHS & no Sb/Br)	CU NIPDAU	Level-1-260C-UNLIM
74FCT162H245ATPACT	ACTIVE	TSSOP	DGG	48	2000	Green (RoHS & no Sb/Br)	CU NIPDAU	Level-1-260C-UNLIM
74FCT162H245ATPVC	ACTIVE	SSOP	DL	48	25	Green (RoHS & no Sb/Br)	CU NIPDAU	Level-1-260C-UNLIM

Orderable Device	Status <sup>(1)</sup>	Package Type	Package Drawing	Pins	Package Qty	Eco Plan <sup>(2)</sup>	Lead/Ball Finish	MSL Peak Temp <sup>(3)</sup>
						no Sb/Br)		
74FCT162H245ATPVCT	ACTIVE	SSOP	DL	48	1000	Green (RoHS & no Sb/Br)	CU NIPDAU	Level-1-260C-UNLIM
74FCT162H245CTPACT	ACTIVE	TSSOP	DGG	48	2000	Green (RoHS & no Sb/Br)	CU NIPDAU	Level-1-260C-UNLIM
74FCT162H245CTPVC	ACTIVE	SSOP	DL	48	25	Green (RoHS & no Sb/Br)	CU NIPDAU	Level-1-260C-UNLIM
74FCT162H245CTPVCT	ACTIVE	SSOP	DL	48	1000	Green (RoHS & no Sb/Br)	CU NIPDAU	Level-1-260C-UNLIM
74FCT162H245ETPAC	OBSOLETE	TSSOP	DGG	48		TBD	Call TI	Call TI
74FCT162H245ETPACT	OBSOLETE	TSSOP	DGG	48		TBD	Call TI	Call TI
74FCT162H245ETPVC	OBSOLETE	SSOP	DL	48		TBD	Call TI	Call TI
74FCT162H245ETPVCT	OBSOLETE	SSOP	DL	48		TBD	Call TI	Call TI
CY74FCT162245ATPVC	ACTIVE	SSOP	DL	48	25	Green (RoHS & no Sb/Br)	CU NIPDAU	Level-1-260C-UNLIM
CY74FCT162245CTPVC	ACTIVE	SSOP	DL	48	25	Green (RoHS & no Sb/Br)	CU NIPDAU	Level-1-260C-UNLIM
CY74FCT162245ETPAC	OBSOLETE	TSSOP	DGG	48		TBD	Call TI	Call TI
CY74FCT162245ETPVC	OBSOLETE	SSOP	DL	48		TBD	Call TI	Call TI
CY74FCT162245TPACT	ACTIVE	TSSOP	DGG	48	2000	Green (RoHS & no Sb/Br)	CU NIPDAU	Level-1-260C-UNLIM
CY74FCT162245TPVC	ACTIVE	SSOP	DL	48	25	Green (RoHS & no Sb/Br)	CU NIPDAU	Level-1-260C-UNLIM
CY74FCT162245TPVCT	ACTIVE	SSOP	DL	48	1000	Green (RoHS & no Sb/Br)	CU NIPDAU	Level-1-260C-UNLIM
CY74FCT16245ATPACT	ACTIVE	TSSOP	DGG	48	2000	Green (RoHS & no Sb/Br)	CU NIPDAU	Level-1-260C-UNLIM
CY74FCT16245ATPVC	ACTIVE	SSOP	DL	48	25	Green (RoHS & no Sb/Br)	CU NIPDAU	Level-1-260C-UNLIM
CY74FCT16245ATPVCT	ACTIVE	SSOP	DL	48	1000	Green (RoHS & no Sb/Br)	CU NIPDAU	Level-1-260C-UNLIM
CY74FCT16245CTPACT	ACTIVE	TSSOP	DGG	48	2000	Green (RoHS & no Sb/Br)	CU NIPDAU	Level-1-260C-UNLIM
CY74FCT16245CTPVC	ACTIVE	SSOP	DL	48	25	Green (RoHS & no Sb/Br)	CU NIPDAU	Level-1-260C-UNLIM
CY74FCT16245CTPVCT	ACTIVE	SSOP	DL	48	1000	Green (RoHS & no Sb/Br)	CU NIPDAU	Level-1-260C-UNLIM
CY74FCT16245ETPAC	OBSOLETE	TSSOP	DGG	48		TBD	Call TI	Call TI
CY74FCT16245ETPACT	OBSOLETE	TSSOP	DGG	48		TBD	Call TI	Call TI
CY74FCT16245ETPVC	OBSOLETE	SSOP	DL	48		TBD	Call TI	Call TI
CY74FCT16245ETPVCT	OBSOLETE	SSOP	DL	48		TBD	Call TI	Call TI
CY74FCT16245TPACT	ACTIVE	TSSOP	DGG	48	2000	Green (RoHS & no Sb/Br)	CU NIPDAU	Level-1-260C-UNLIM
CY74FCT16245TPVC	ACTIVE	SSOP	DL	48	25	Green (RoHS & no Sb/Br)	CU NIPDAU	Level-1-260C-UNLIM
CY74FCT16245TPVCT	ACTIVE	SSOP	DL	48	1000	Green (RoHS & no Sb/Br)	CU NIPDAU	Level-1-260C-UNLIM
FCT162245ATPACTE4	ACTIVE	TSSOP	DGG	48	2000	Green (RoHS & no Sb/Br)	CU NIPDAU	Level-1-260C-UNLIM

Orderable Device	Status <sup>(1)</sup>	Package Type	Package Drawing	Pins	Package Qty	Eco Plan <sup>(2)</sup>	Lead/Ball Finish	MSL Peak Temp <sup>(3)</sup>
FCT162245ATPACTG4	ACTIVE	TSSOP	DGG	48	2000	Green (RoHS & no Sb/Br)	CU NIPDAU	Level-1-260C-UNLIM
FCT162245ATPVCTG4	ACTIVE	SSOP	DL	48	1000	Green (RoHS & no Sb/Br)	CU NIPDAU	Level-1-260C-UNLIM
FCT162245CTPACTE4	ACTIVE	TSSOP	DGG	48	2000	Green (RoHS & no Sb/Br)	CU NIPDAU	Level-1-260C-UNLIM
FCT162245CTPACTG4	ACTIVE	TSSOP	DGG	48	2000	Green (RoHS & no Sb/Br)	CU NIPDAU	Level-1-260C-UNLIM
FCT162245CTPVCTG4	ACTIVE	SSOP	DL	48	1000	Green (RoHS & no Sb/Br)	CU NIPDAU	Level-1-260C-UNLIM
FCT162H245ATPACTE4	ACTIVE	TSSOP	DGG	48	2000	Green (RoHS & no Sb/Br)	CU NIPDAU	Level-1-260C-UNLIM
FCT162H245ATPACTG4	ACTIVE	TSSOP	DGG	48	2000	Green (RoHS & no Sb/Br)	CU NIPDAU	Level-1-260C-UNLIM
FCT162H245ATPVCG4	ACTIVE	SSOP	DL	48	25	Green (RoHS & no Sb/Br)	CU NIPDAU	Level-1-260C-UNLIM
FCT162H245ATPVCTG4	ACTIVE	SSOP	DL	48	1000	Green (RoHS & no Sb/Br)	CU NIPDAU	Level-1-260C-UNLIM
FCT162H245CTPACTE4	ACTIVE	TSSOP	DGG	48	2000	Green (RoHS & no Sb/Br)	CU NIPDAU	Level-1-260C-UNLIM
FCT162H245CTPACTG4	ACTIVE	TSSOP	DGG	48	2000	Green (RoHS & no Sb/Br)	CU NIPDAU	Level-1-260C-UNLIM
FCT162H245CTPVCG4	ACTIVE	SSOP	DL	48	25	Green (RoHS & no Sb/Br)	CU NIPDAU	Level-1-260C-UNLIM
FCT162H245CTPVCTG4	ACTIVE	SSOP	DL	48	1000	Green (RoHS & no Sb/Br)	CU NIPDAU	Level-1-260C-UNLIM

<sup>(1)</sup> The marketing status values are defined as follows:

**ACTIVE:** Product device recommended for new designs.

**LIFEBUY:** TI has announced that the device will be discontinued, and a lifetime-buy period is in effect.

**NRND:** Not recommended for new designs. Device is in production to support existing customers, but TI does not recommend using this part in a new design.

**PREVIEW:** Device has been announced but is not in production. Samples may or may not be available.

**OBSOLETE:** TI has discontinued the production of the device.

<sup>(2)</sup> Eco Plan - The planned eco-friendly classification: Pb-Free (RoHS), Pb-Free (RoHS Exempt), or Green (RoHS & no Sb/Br) - please check <http://www.ti.com/productcontent> for the latest availability information and additional product content details.

**TBD:** The Pb-Free/Green conversion plan has not been defined.

**Pb-Free (RoHS):** TI's terms "Lead-Free" or "Pb-Free" mean semiconductor products that are compatible with the current RoHS requirements for all 6 substances, including the requirement that lead not exceed 0.1% by weight in homogeneous materials. Where designed to be soldered at high temperatures, TI Pb-Free products are suitable for use in specified lead-free processes.

**Pb-Free (RoHS Exempt):** This component has a RoHS exemption for either 1) lead-based flip-chip solder bumps used between the die and package, or 2) lead-based die adhesive used between the die and leadframe. The component is otherwise considered Pb-Free (RoHS compatible) as defined above.

**Green (RoHS & no Sb/Br):** TI defines "Green" to mean Pb-Free (RoHS compatible), and free of Bromine (Br) and Antimony (Sb) based flame retardants (Br or Sb do not exceed 0.1% by weight in homogeneous material)

<sup>(3)</sup> MSL, Peak Temp. -- The Moisture Sensitivity Level rating according to the JEDEC industry standard classifications, and peak solder temperature.

**Important Information and Disclaimer:** The information provided on this page represents TI's knowledge and belief as of the date that it is provided. TI bases its knowledge and belief on information provided by third parties, and makes no representation or warranty as to the accuracy of such information. Efforts are underway to better integrate information from third parties. TI has taken and continues to take reasonable steps to provide representative and accurate information but may not have conducted destructive testing or chemical analysis on incoming materials and chemicals. TI and TI suppliers consider certain information to be proprietary, and thus CAS numbers and other limited information may not be available for release.

In no event shall TI's liability arising out of such information exceed the total purchase price of the TI part(s) at issue in this document sold by TI to Customer on an annual basis.

**TAPE AND REEL INFORMATION**



**QUADRANT ASSIGNMENTS FOR PIN 1 ORIENTATION IN TAPE**



\*All dimensions are nominal

Device	Package Type	Package Drawing	Pins	SPQ	Reel Diameter (mm)	Reel Width W1 (mm)	A0 (mm)	B0 (mm)	K0 (mm)	P1 (mm)	W (mm)	Pin1 Quadrant
74FCT162245ATPACT	TSSOP	DGG	48	2000	330.0	24.4	8.6	15.8	1.8	12.0	24.0	Q1
74FCT162245ATPVCT	SSOP	DL	48	1000	330.0	32.4	11.35	16.2	3.1	16.0	32.0	Q1
74FCT162245CTPACT	TSSOP	DGG	48	2000	330.0	24.4	8.6	15.8	1.8	12.0	24.0	Q1
74FCT162245CTPVCT	SSOP	DL	48	1000	330.0	32.4	11.35	16.2	3.1	16.0	32.0	Q1
74FCT162H245ATPACT	TSSOP	DGG	48	2000	330.0	24.4	8.6	15.8	1.8	12.0	24.0	Q1
74FCT162H245ATPVCT	SSOP	DL	48	1000	330.0	32.4	11.35	16.2	3.1	16.0	32.0	Q1
74FCT162H245CTPACT	TSSOP	DGG	48	2000	330.0	24.4	8.6	15.8	1.8	12.0	24.0	Q1
74FCT162H245CTPVCT	SSOP	DL	48	1000	330.0	32.4	11.35	16.2	3.1	16.0	32.0	Q1
CY74FCT162245TPACT	TSSOP	DGG	48	2000	330.0	24.4	8.6	15.8	1.8	12.0	24.0	Q1
CY74FCT162245TPVCT	SSOP	DL	48	1000	330.0	32.4	11.35	16.2	3.1	16.0	32.0	Q1
CY74FCT16245ATPACT	TSSOP	DGG	48	2000	330.0	24.4	8.6	15.8	1.8	12.0	24.0	Q1
CY74FCT16245ATPVCT	SSOP	DL	48	1000	330.0	32.4	11.35	16.2	3.1	16.0	32.0	Q1
CY74FCT16245CTPACT	TSSOP	DGG	48	2000	330.0	24.4	8.6	15.8	1.8	12.0	24.0	Q1
CY74FCT16245CTPVCT	SSOP	DL	48	1000	330.0	32.4	11.35	16.2	3.1	16.0	32.0	Q1
CY74FCT16245TPACT	TSSOP	DGG	48	2000	330.0	24.4	8.6	15.8	1.8	12.0	24.0	Q1
CY74FCT16245TPVCT	SSOP	DL	48	1000	330.0	32.4	11.35	16.2	3.1	16.0	32.0	Q1

**TAPE AND REEL BOX DIMENSIONS**



\*All dimensions are nominal

Device	Package Type	Package Drawing	Pins	SPQ	Length (mm)	Width (mm)	Height (mm)
74FCT162245ATPACT	TSSOP	DGG	48	2000	346.0	346.0	41.0
74FCT162245ATPVCT	SSOP	DL	48	1000	346.0	346.0	49.0
74FCT162245CTPACT	TSSOP	DGG	48	2000	346.0	346.0	41.0
74FCT162245CTPVCT	SSOP	DL	48	1000	346.0	346.0	49.0
74FCT162H245ATPACT	TSSOP	DGG	48	2000	346.0	346.0	41.0
74FCT162H245ATPVCT	SSOP	DL	48	1000	346.0	346.0	49.0
74FCT162H245CTPACT	TSSOP	DGG	48	2000	346.0	346.0	41.0
74FCT162H245CTPVCT	SSOP	DL	48	1000	346.0	346.0	49.0
CY74FCT162245TPACT	TSSOP	DGG	48	2000	346.0	346.0	41.0
CY74FCT162245TPVCT	SSOP	DL	48	1000	346.0	346.0	49.0
CY74FCT16245ATPACT	TSSOP	DGG	48	2000	346.0	346.0	41.0
CY74FCT16245ATPVCT	SSOP	DL	48	1000	346.0	346.0	49.0
CY74FCT16245CTPACT	TSSOP	DGG	48	2000	346.0	346.0	41.0
CY74FCT16245CTPVCT	SSOP	DL	48	1000	346.0	346.0	49.0
CY74FCT16245TPACT	TSSOP	DGG	48	2000	346.0	346.0	41.0
CY74FCT16245TPVCT	SSOP	DL	48	1000	346.0	346.0	49.0

DGG (R-PDSO-G\*\*)

PLASTIC SMALL-OUTLINE PACKAGE

48 PINS SHOWN



- NOTES: A. All linear dimensions are in millimeters.  
 B. This drawing is subject to change without notice.  
 C. Body dimensions do not include mold protrusion not to exceed 0,15.  
 D. Falls within JEDEC MO-153

DL (R-PDSO-G\*\*)

PLASTIC SMALL-OUTLINE PACKAGE

48 PINS SHOWN



- NOTES: A. All linear dimensions are in inches (millimeters).  
 B. This drawing is subject to change without notice.  
 C. Body dimensions do not include mold flash or protrusion not to exceed 0.006 (0,15).  
 D. Falls within JEDEC MO-118



## IMPORTANT NOTICE

Texas Instruments Incorporated and its subsidiaries (TI) reserve the right to make corrections, modifications, enhancements, improvements, and other changes to its products and services at any time and to discontinue any product or service without notice. Customers should obtain the latest relevant information before placing orders and should verify that such information is current and complete. All products are sold subject to TI's terms and conditions of sale supplied at the time of order acknowledgment.

TI warrants performance of its hardware products to the specifications applicable at the time of sale in accordance with TI's standard warranty. Testing and other quality control techniques are used to the extent TI deems necessary to support this warranty. Except where mandated by government requirements, testing of all parameters of each product is not necessarily performed.

TI assumes no liability for applications assistance or customer product design. Customers are responsible for their products and applications using TI components. To minimize the risks associated with customer products and applications, customers should provide adequate design and operating safeguards.

TI does not warrant or represent that any license, either express or implied, is granted under any TI patent right, copyright, mask work right, or other TI intellectual property right relating to any combination, machine, or process in which TI products or services are used. Information published by TI regarding third-party products or services does not constitute a license from TI to use such products or services or a warranty or endorsement thereof. Use of such information may require a license from a third party under the patents or other intellectual property of the third party, or a license from TI under the patents or other intellectual property of TI.

Reproduction of TI information in TI data books or data sheets is permissible only if reproduction is without alteration and is accompanied by all associated warranties, conditions, limitations, and notices. Reproduction of this information with alteration is an unfair and deceptive business practice. TI is not responsible or liable for such altered documentation. Information of third parties may be subject to additional restrictions.

Resale of TI products or services with statements different from or beyond the parameters stated by TI for that product or service voids all express and any implied warranties for the associated TI product or service and is an unfair and deceptive business practice. TI is not responsible or liable for any such statements.

TI products are not authorized for use in safety-critical applications (such as life support) where a failure of the TI product would reasonably be expected to cause severe personal injury or death, unless officers of the parties have executed an agreement specifically governing such use. Buyers represent that they have all necessary expertise in the safety and regulatory ramifications of their applications, and acknowledge and agree that they are solely responsible for all legal, regulatory and safety-related requirements concerning their products and any use of TI products in such safety-critical applications, notwithstanding any applications-related information or support that may be provided by TI. Further, Buyers must fully indemnify TI and its representatives against any damages arising out of the use of TI products in such safety-critical applications.

TI products are neither designed nor intended for use in military/aerospace applications or environments unless the TI products are specifically designated by TI as military-grade or "enhanced plastic." Only products designated by TI as military-grade meet military specifications. Buyers acknowledge and agree that any such use of TI products which TI has not designated as military-grade is solely at the Buyer's risk, and that they are solely responsible for compliance with all legal and regulatory requirements in connection with such use.

TI products are neither designed nor intended for use in automotive applications or environments unless the specific TI products are designated by TI as compliant with ISO/TS 16949 requirements. Buyers acknowledge and agree that, if they use any non-designated products in automotive applications, TI will not be responsible for any failure to meet such requirements.

Following are URLs where you can obtain information on other Texas Instruments products and application solutions:

### Products

Amplifiers	<a href="http://amplifier.ti.com">amplifier.ti.com</a>
Data Converters	<a href="http://dataconverter.ti.com">dataconverter.ti.com</a>
DSP	<a href="http://dsp.ti.com">dsp.ti.com</a>
Clocks and Timers	<a href="http://www.ti.com/clocks">www.ti.com/clocks</a>
Interface	<a href="http://interface.ti.com">interface.ti.com</a>
Logic	<a href="http://logic.ti.com">logic.ti.com</a>
Power Mgmt	<a href="http://power.ti.com">power.ti.com</a>
Microcontrollers	<a href="http://microcontroller.ti.com">microcontroller.ti.com</a>
RFID	<a href="http://www.ti-rfid.com">www.ti-rfid.com</a>
RF/IF and ZigBee® Solutions	<a href="http://www.ti.com/lprf">www.ti.com/lprf</a>

### Applications

Audio	<a href="http://www.ti.com/audio">www.ti.com/audio</a>
Automotive	<a href="http://www.ti.com/automotive">www.ti.com/automotive</a>
Broadband	<a href="http://www.ti.com/broadband">www.ti.com/broadband</a>
Digital Control	<a href="http://www.ti.com/digitalcontrol">www.ti.com/digitalcontrol</a>
Medical	<a href="http://www.ti.com/medical">www.ti.com/medical</a>
Military	<a href="http://www.ti.com/military">www.ti.com/military</a>
Optical Networking	<a href="http://www.ti.com/opticalnetwork">www.ti.com/opticalnetwork</a>
Security	<a href="http://www.ti.com/security">www.ti.com/security</a>
Telephony	<a href="http://www.ti.com/telephony">www.ti.com/telephony</a>
Video & Imaging	<a href="http://www.ti.com/video">www.ti.com/video</a>
Wireless	<a href="http://www.ti.com/wireless">www.ti.com/wireless</a>

Mailing Address: Texas Instruments, Post Office Box 655303, Dallas, Texas 75265  
Copyright © 2008, Texas Instruments Incorporated