



FEATURES

- 20 WATTS OUTPUT POWER
- OUTPUT CURRENT UP TO 4A
- STANDARD 2" X 1.6" X 0.4" PACKAGE
- HIGH EFFICIENCY UP TO 87%
- 2:1 AND 4:1 WIDE INPUT VOLTAGE RANGE
- SIX-SIDED CONTINUOUS SHIELD
- FIXED SWITCHING FREQUENCY
- CE MARK MEETS 2006/95/EC, 93/68/EEC AND 2004/108/EC
- UL60950-1, EN60950-1 AND IEC60950-1 LICENSED
- ISO9001 CERTIFIED MANUFACTURING FACILITIES
- COMPLIANT TO RoHS EU DIRECTIVE 2002/95/EC

APPLICATIONS

Wireless Network
Telecom/Datacom
Industry Control System
Measurement Equipment
Semiconductor Equipment

DESCRIPTION

The FDC20 and FDC20-W series offer 20 Watts of output power from a 2 x 1.6 x 0.4 inch package. The FDC20 series with 2:1 wide input voltage of 9-18, 18-36 and 36-75VDC. The FDC20-W series with 4:1 wide input voltage of 9-36 and 18-75VDC.

TECHNICAL SPECIFICATION All specifications are typical at nominal input, full load and 25°C otherwise noted

| OUTPUT SPECIFICATIONS | | | |
|----------------------------------|--|-----------------------------|-----------------|
| Output power | 20 Watts, max. | | |
| Voltage accuracy | Full load and nominal Vin | Single & Dual | ± 1% |
| | | Triple 3.3V/5V | ± 1% |
| | | Auxiliary | ± 5% |
| | Minimum load (Note 6) | See Table | |
| Voltage adjustability | ± 10% | | |
| Line regulation | LL to HL at Full Load | Single (W) | ± 0.2% |
| | | Dual (W) | ± 0.5% |
| | | Triple 3.3V/5V | ± 1% |
| | | Auxiliary | ± 5% |
| Load regulation | Min. Load to Full Load | Single | ± 0.5% |
| | | Dual | ± 3% |
| | | Triple 3.3V/5V | ± 2% |
| | | Auxiliary | ± 5% |
| Cross regulation (Note 7) | Dual | Triple 3.3V/5V | ± 2% |
| | | Auxiliary | ± 5% |
| | | Ripple and noise | 20MHz bandwidth |
| Temperature coefficient | ±0.02% / °C, max. | | |
| Transient response recovery time | 25% load step change | Single | 250µS |
| | | Dual | 250µS |
| | | Triple | 500µS |
| Over voltage protection | 3.3V output | 3.9VDC | |
| | 5V output | 6.2VDC | |
| Zener diode clamp | 12V output | 15VDC | |
| | 15V output | 18VDC | |
| | Over load protection | % of FL at nominal input | 150%, max. |
| Short circuit protection | Hiccup, automatics recovery | | |
| GENERAL SPECIFICATIONS | | | |
| Efficiency | See table | | |
| Isolation voltage | 1600VDC, min. | | |
| Isolation resistance | 10 ⁹ ohms, min. | | |
| Isolation capacitance | 300pF, max. | | |
| Switching frequency | 300KHz, typ. | | |
| Approvals and standard | IEC60950-1, UL60950-1, EN60950-1 | | |
| Case material | Nickel-coated copper | | |
| Base material | Non-conductive black plastic | | |
| Potting material | Epoxy (UL94-V0) | | |
| Dimensions | 2.00 X 1.60 X 0.40 Inch (50.8 X 40.6 X 10.2 mm) | | |
| Weight | 48g (1.69oz) | | |
| MTBF (Note 1) | BELLCORE TR-NWT-000332 | 1.928 x 10 ⁶ hrs | |
| | MIL-HDBK-217F | 7.650 x 10 ⁵ hrs | |

| INPUT SPECIFICATIONS | | | |
|-------------------------------------|--|-------------------------|------------------|
| Input voltage range | FDC20 | 12V nominal input | 9 – 18VDC |
| | | 24V nominal input | 18 – 36VDC |
| | | 48V nominal input | 36 – 75VDC |
| | FDC20-W | 24V nominal input | 9 – 36VDC |
| | | 48V nominal input | 18 – 75VDC |
| Input filter | Pi type | | |
| Input surge voltage | 12V input | 36VDC | |
| | 24V input | 50VDC | |
| | 100mS max | 48V input | 100VDC |
| Input reflected ripple current | Nominal Vin and full load | 25mA _{p-p} | |
| Start up time | Nominal Vin and constant resistive load | Power up | 20mS, typ. |
| | Remote ON/OFF (Note 8) (Positive logic) | | |
| | DC-DC ON | Open or 3.5V < Vr < 12V | |
| | DC-DC OFF | Short or 0V < Vr < 1.2V | |
| Input current of remote control pin | Nominal Vin | -0.5~1.0mA | |
| Remote off state input current | Nominal Vin | 20mA | |
| ENVIRONMENTAL SPECIFICATIONS | | | |
| Operating ambient temperature | -40°C ~ +85°C (with derating) | | |
| Maximum case temperature | +100°C | | |
| Storage temperature range | -55°C ~ +105°C | | |
| Thermal impedance (Note 9) | Nature convection | 10°C/watt | |
| | Nature convection with heat-sink | 8.24°C/watt | |
| Thermal shock | MIL-STD-810F | | |
| Vibration | MIL-STD-810F | | |
| Relative humidity | 5% to 95% RH | | |
| EMC CHARACTERISTICS | | | |
| EMI (Note 10) | EN55022 | Class A | |
| ESD | EN61000-4-2 | Air | ± 8KV |
| | | Contact | ± 6KV |
| Radiated immunity | EN61000-4-3 | 10 V/m | Perf. Criteria A |
| Fast transient (Note 11) | EN61000-4-4 | ± 2KV | Perf. Criteria B |
| Surge (Note 11) | EN61000-4-5 | ± 1KV | Perf. Criteria B |
| Conducted immunity | EN61000-4-6 | 10 V _{r.m.s} | Perf. Criteria A |

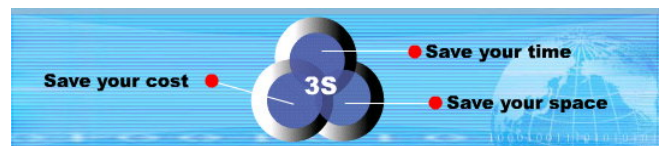



| Model Number | Input Range | Output Voltage | Output Current | | Output ⁽⁴⁾ Ripple & Noise | Input Current | | Eff ⁽⁴⁾ (%) | Capacitor ⁽⁵⁾ Load max |
|-----------------|-----------------------|----------------|----------------|----------------|---|------------------------|--------------------------|---------------------------|--------------------------------------|
| | | | Min. load | Full load | | No load ⁽³⁾ | Full load ⁽²⁾ | | |
| FDC20-12S33 | 9 – 18 VDC | 3.3 VDC | 280mA | 4000mA | 75mVp-p | 40mA | 1507mA | 77 | 13000µF |
| FDC20-12S05 | 9 – 18 VDC | 5 VDC | 280mA | 4000mA | 75mVp-p | 15mA | 2193mA | 80 | 6800µF |
| FDC20-12S12 | 9 – 18 VDC | 12 VDC | 134mA | 1670mA | 75mVp-p | 40mA | 2110mA | 83 | 2200µF |
| FDC20-12S15 | 9 – 18 VDC | 15 VDC | 106mA | 1330mA | 75mVp-p | 20mA | 2083mA | 84 | 755µF |
| FDC20-12D05 | 9 – 18 VDC | ± 5 VDC | ± 140mA | ± 2000mA | 100mVp-p | 15mA | 2136mA | 82 | ± 3400µF |
| FDC20-12D12 | 9 – 18 VDC | ± 12 VDC | ± 67mA | ± 833mA | 100mVp-p | 35mA | 2110mA | 83 | ± 680µF |
| FDC20-12D15 | 9 – 18 VDC | ± 15 VDC | ± 53mA | ± 666mA | 100mVp-p | 35mA | 2110mA | 83 | ± 450µF |
| FDC20-12T3312 | 9 – 18 VDC | 3.3 / ± 12 VDC | 300 / ± 30mA | 3000 / ± 300mA | 50 / ± 120mVp-p | 20mA | 1900mA | 79 | 4700 / ± 220µF |
| FDC20-12T3315 | 9 – 18 VDC | 3.3 / ± 15 VDC | 300 / ± 25mA | 3000 / ± 250mA | 50 / ± 150mVp-p | 35mA | 1933mA | 79 | 4700 / ± 220µF |
| FDC20-12T0512 | 9 – 18 VDC | 5 / ± 12 VDC | 200 / ± 30mA | 2000 / ± 300mA | 50 / ± 120mVp-p | 20mA | 1885mA | 80 | 4700 / ± 220µF |
| FDC20-12T0515 | 9 – 18 VDC | 5 / ± 15 VDC | 200 / ± 25mA | 2000 / ± 250mA | 50 / ± 150mVp-p | 40mA | 1919mA | 80 | 4700 / ± 220µF |
| FDC20-24S33 (W) | 18 – 36 (9 – 36) VDC | 3.3 VDC | 280mA | 4000mA | 75mVp-p | 10(20)mA | 733 (764mA) | 79 (76) | 13000µF |
| FDC20-24S05 (W) | 18 – 36 (9 – 36) VDC | 5 VDC | 280mA | 4000mA | 75mVp-p | 10(10)mA | 1082 (1111mA) | 81 (79) | 6800µF |
| FDC20-24S12 (W) | 18 – 36 (9 – 36) VDC | 12 VDC | 134mA | 1670mA | 75mVp-p | 10(20)mA | 1018 (1082mA) | 86 (81) | 2200µF |
| FDC20-24S15 (W) | 18 – 36 (9 – 36) VDC | 15 VDC | 106mA | 1330mA | 75mVp-p | 15(20)mA | 1018 (1082mA) | 86 (81) | 755µF |
| FDC20-24D05 (W) | 18 – 36 (9 – 36) VDC | ± 5 VDC | ± 140mA | ± 2000mA | 100mVp-p | 20(15)mA | 1028 (1111mA) | 85 (79) | ± 3400µF |
| FDC20-24D12 (W) | 18 – 36 (9 – 36) VDC | ± 12 VDC | ± 67mA | ± 833mA | 100mVp-p | 25(20)mA | 1016 (1068mA) | 86 (82) | ± 680µF |
| FDC20-24D15 (W) | 18 – 36 (9 – 36) VDC | ± 15 VDC | ± 53mA | ± 666mA | 100mVp-p | 30(25)mA | 1015 (1068mA) | 86 (82) | ± 450µF |
| FDC20-24T3312 | 18 – 36 VDC | 3.3 / ± 12 VDC | 300 / ± 30mA | 3000 / ± 300mA | 50 / ± 120mVp-p | 20mA | 914mA | 82 | 4700 / ± 220µF |
| FDC20-24T3315 | 18 – 36 VDC | 3.3 / ± 15 VDC | 300 / ± 25mA | 3000 / ± 250mA | 50 / ± 150mVp-p | 20mA | 967mA | 79 | 4700 / ± 220µF |
| FDC20-24T0512 | 18 – 36 VDC | 5 / ± 12 VDC | 200 / ± 30mA | 2000 / ± 300mA | 50 / ± 120mVp-p | 25mA | 907mA | 83 | 4700 / ± 220µF |
| FDC20-24T0515 | 18 – 36 VDC | 5 / ± 15 VDC | 200 / ± 25mA | 2000 / ± 250mA | 50 / ± 150mVp-p | 10mA | 922mA | 83 | 4700 / ± 220µF |
| FDC20-48S33 (W) | 36 – 75 (18 – 75) VDC | 3.3 VDC | 280mA | 4000mA | 75mVp-p | 10(15)mA | 367 (377mA) | 79 (77) | 13000µF |
| FDC20-48S05 (W) | 36 – 75 (18 – 75) VDC | 5 VDC | 280mA | 4000mA | 75mVp-p | 10(10)mA | 543 (548mA) | 82 (80) | 6800µF |
| FDC20-48S12 (W) | 36 – 75 (18 – 75) VDC | 12 VDC | 134mA | 1670mA | 75mVp-p | 15(10)mA | 509 (536mA) | 86 (82) | 2200µF |
| FDC20-48S15 (W) | 36 – 75 (18 – 75) VDC | 15 VDC | 106mA | 1330mA | 75mVp-p | 25(10)mA | 506 (532mA) | 86 (82) | 755µF |
| FDC20-48D05 (W) | 36 – 75 (18 – 75) VDC | ± 5 VDC | ± 140mA | ± 2000mA | 100mVp-p | 15(10)mA | 514 (541mA) | 85 (81) | ± 3400µF |
| FDC20-48D12 (W) | 36 – 75 (18 – 75) VDC | ± 12 VDC | ± 67mA | ± 833mA | 100mVp-p | 15(15)mA | 502 (527mA) | 87 (83) | ± 680µF |
| FDC20-48D15 (W) | 36 – 75 (18 – 75) VDC | ± 15 VDC | ± 53mA | ± 666mA | 100mVp-p | 20(20)mA | 502 (527mA) | 87 (83) | ± 450µF |
| FDC20-48T3312 | 36 – 75 VDC | 3.3 / ± 12 VDC | 300 / ± 30mA | 3000 / ± 300mA | 50 / ± 120mVp-p | 10mA | 457mA | 82 | 4700 / ± 220µF |
| FDC20-48T3315 | 36 – 75 VDC | 3.3 / ± 15 VDC | 300 / ± 25mA | 3000 / ± 250mA | 50 / ± 150mVp-p | 10mA | 464mA | 82 | 4700 / ± 220µF |
| FDC20-48T0512 | 36 – 75 VDC | 5 / ± 12 VDC | 200 / ± 30mA | 2000 / ± 300mA | 50 / ± 120mVp-p | 15mA | 448mA | 84 | 4700 / ± 220µF |
| FDC20-48T0515 | 36 – 75 VDC | 5 / ± 15 VDC | 200 / ± 25mA | 2000 / ± 250mA | 50 / ± 150mVp-p | 15mA | 456mA | 84 | 4700 / ± 220µF |

⁽¹²⁾FDC20-24D3305 and FDC20-48D3305, Output 3.3V(3A)/5V(2A), Detail Spec. Contact Factory.

Note

- BELLCORE TR-NWT-000332. Case 1: 50% Stress, Temperature at 40°C. MIL-HDBK-217F Notice2 @Ta=25 °C, Full load(Ground, Benign, controlled environment).
- Maximum value at nominal input voltage and full load.
- Typical value at nominal input voltage and no load.
- Typical value at nominal input voltage and full load.
- Test by minimum Vin and constant resistive load.
- The output requires a minimum loading on the output to maintain specified regulation. Operation under no-load condition will not damage these devices, however they may not meet all listed specification.
- Cross regulation : Dual output—Asymmetrical load 25% to 100% full load
Triple output – 3.3V / 5V 100% load and one of auxiliary 100% load, other auxiliary load change from 25% to 100% load
- The ON/OFF control pin voltage is referenced to -Vin
- Heat sink is optional and P/N: 7G-0011C-F and the operation temperature range please see curve.
- The FDC20 series can meet EN55022 Class A with parallel an external capacitor to the input pins.
Recommend: 12Vin : 6.8µF/50V 1812 MLCC . 24Vin : N/A. 48Vin : 2.2µF/100V 1812 MLCC .
- An external input filter capacitor is required if the module has to meet EN61000-4-4, EN61000-4-5.
The filter capacitor Power Mate suggest: Nippon chemi-con KY series, 220 µF/100V, ESR 48mΩ .
- The FDC20-24D3305 and FDC20-48D3305 are safety approval pending.

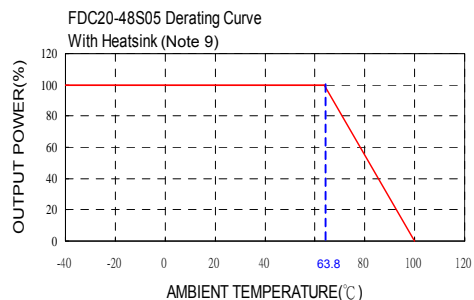
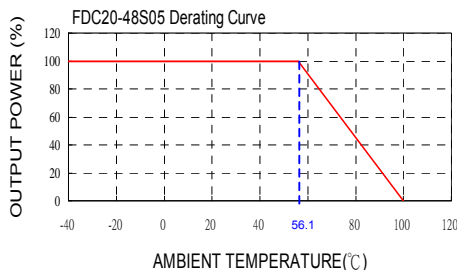

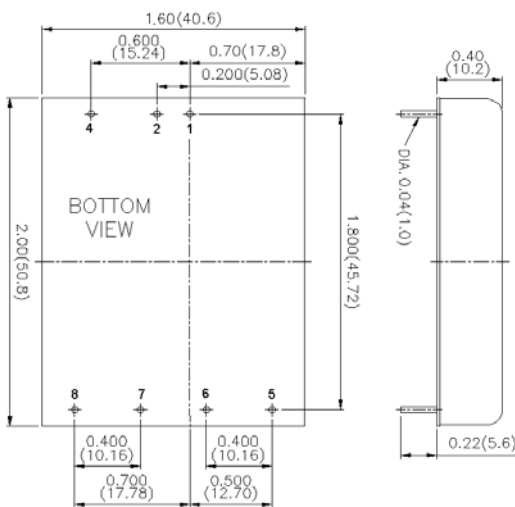
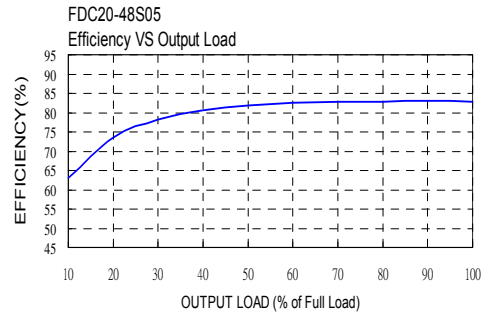
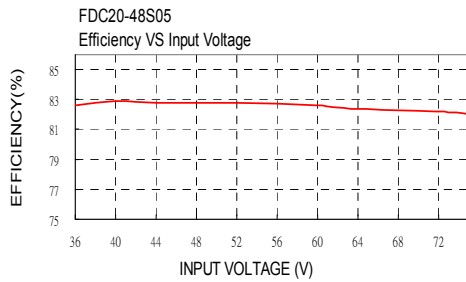

- All dimensions in Inches (mm)
Tolerance: X.XX±0.02 (X.X±0.5)
X.XXX±0.01 (X.XX±0.25)
- Pin pitch tolerance ±0.01(0.25)
- Pin dimension tolerance ±0.004 (0.1)

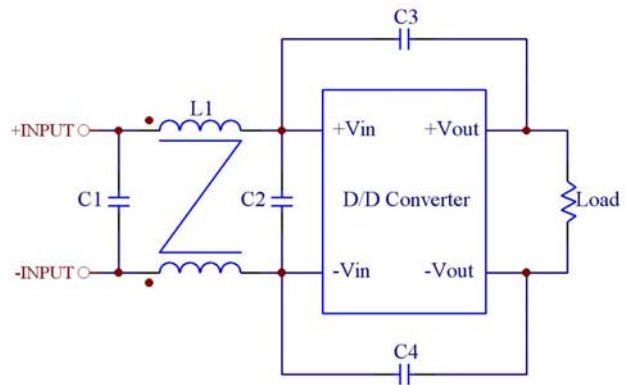

Recommended Filter for EN55022 Class B Compliance

The components used in the above figure, together with the manufacturers' part numbers for these components, are as follows:

| | C1 | C2 | C3 | C4 | L1 |
|-------------|-------------------------|-------------------------|--------------------|--------------------|-------------------------------------|
| FDC20-12xxx | 4.7µF/50V 1812 MLCC | N/A | 1000pF/2KV MLCC | 1000pF/2KV MLCC | 450µH Common Choke PMT-048 |
| FDC20-24xxx | 4.7µF/50V 1812 MLCC | N/A | 1000pF/2KV MLCC | 1000pF/2KV MLCC | 450µH Common Choke PMT-048 |
| FDC20-48xxx | 2.2µF/100V 1812 MLCC | 2.2µF/100V 1812 MLCC | 1000pF/2KV MLCC | 1000pF/2KV MLCC | 450µH Common Choke PMT-048 |

| PIN CONNECTION | | | |
|----------------|----------|----------|-------------|
| PIN | SINGLE | DUAL | TRIPLE |
| 1 | + INPUT | + INPUT | + INPUT |
| 2 | - INPUT | - INPUT | - INPUT |
| 4 | CTRL | CTRL | CTRL |
| 5 | NO PIN | + OUTPUT | + AUXILIARY |
| 6 | + OUTPUT | COMMON | +3.3V / +5V |
| 7 | - OUTPUT | - OUTPUT | COMMON |
| 8 | TRIM | TRIM | - AUXILIARY |

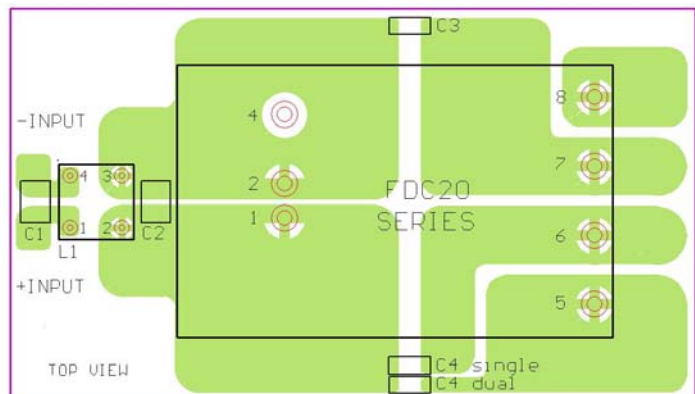
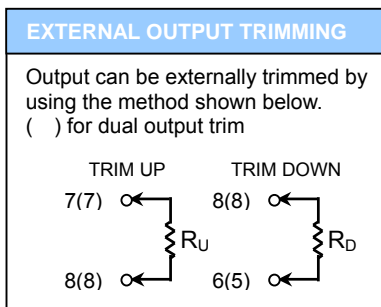

Recommended EN55022 Class B Filter Circuit Layout