

# FIBER COUPLED LASER MODULE (375 NM)

## FCLM375 Series

The FCLM™ Laser Module is a temperature stabilized semiconductor laser coupled with single mode fiber. It features very low M<sup>2</sup> value Gaussian beam output with excellent beam pointing stability at a wide temperature dynamic range. The unique designed electrical driver enable this optical engine has the lowest power consumptions compare to the similar product in the industry. The FCLM™ Laser Module is a Class III b laser product

### Performance Specification

	Condition	Min	Typ	Max	Unit
<b>Optical Performance</b>					
Wavelength	T= 25°C		375		nm
Output Power	T= 25°C		8		mW
Noise(RMS)	10~20 MHz		0.1	0.3	%
Power Stability	1hrs, T= 25°C		0.25	0.5	%
Power Stability	24hrs, T= 25°C		0.75	1	%
Polarization Extinction Ratio		15			dB
<b>Collimated Beam Parameters</b>					
M2				1.2	
Beam Diameter	1/e <sup>2</sup>	0.7, 0.9, 1.5, 2.0, 4.0, 6.0			mm
Beam Divergence	full angle			1	mrad
Pointing Stability	2hrs, T= 25°C			5	urad
Pointing Stability				1	urad/°C
<b>Fiber Information</b>					
Length			1, 2, 3		m
Fiber Type			SM / PM		
Mode Field Diameter			3		um
NA			0.12		
Fiber Jacket Diameter			3		mm
<b>Electrical Parameters</b>					
Power Supply			9		V
Power Consumption			3	10	W
Current(TEC)				2	A
Current(LD)				200	mA
Temperature Stability			0.2		°C
Control			ACC		
Power Setting		0% ~ 100% output power			
<b>Environmental Conditions</b>					
Storage Temperature			0 to + 50		°C
Operation Temperature			+ 10 to + 40		°C
Operation Humidity			No Condensing		
Package Dimensions *			112 x 56 x 26.5		mm

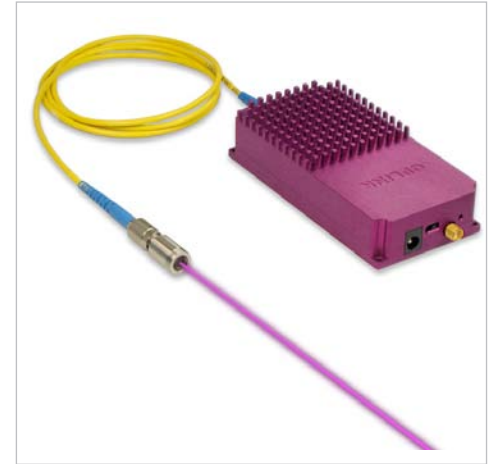

### Features

- ◆ Plug & Play
- ◆ ESD Protection
- ◆ Power Adjustable
- ◆ LD Current Full Protection
- ◆ LD Temperature Stabilized
- ◆ Compact Size

### Applications

- ◆ Polarization Maintaining Fiber
- ◆ High Speed Modulation
- ◆ Remote Control
- ◆ Collimated & Focused Beam
- ◆ Metal Jacket Protection

Note:

\* The mechanical tolerance should be +/-0.2 mm on all package dimensions unless otherwise custom specified.

**FCLM375 SERIES**

**Mechanical Drawing / Package Dimensions (dimension in mm)**



**Ordering Information**

Oplink can provide a remarkable range of customized optical solutions. For detail, please contact Oplink's OEM design team or account manager for your requirements and ordering information (510) 933-7200.

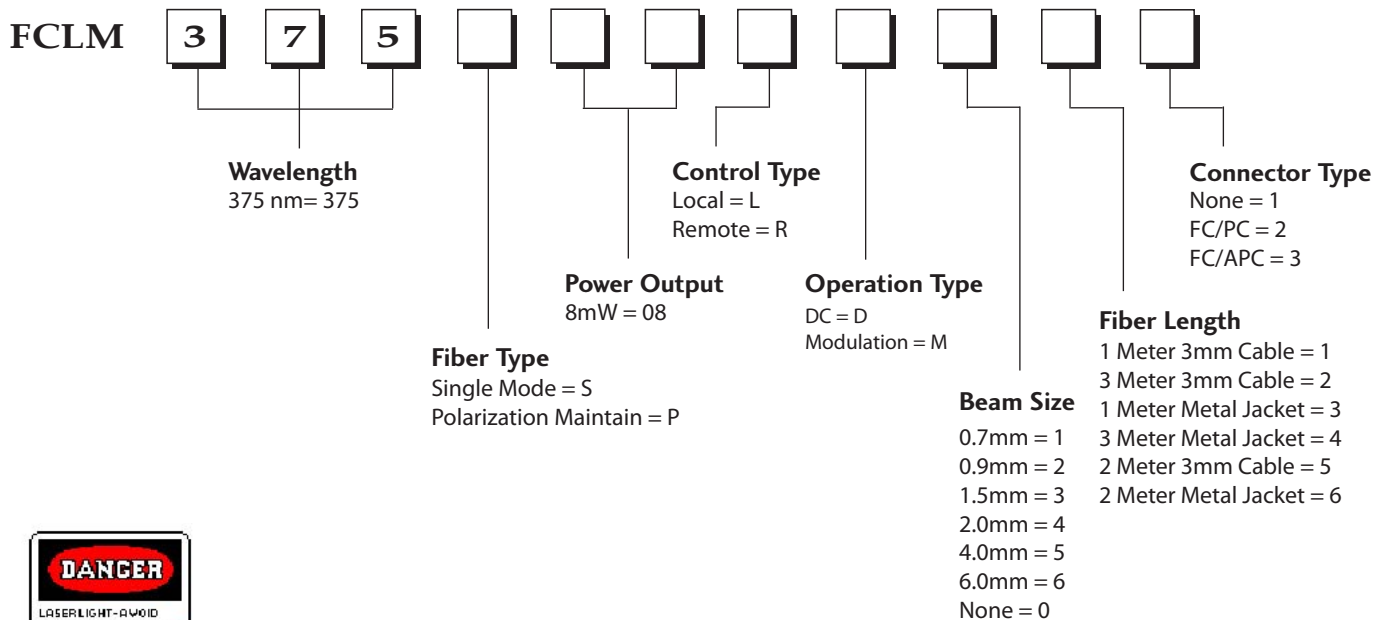

This component does not comply with the Federal Regulations (21 CFR Subchapter 1) as administered by the Center for Devices and Radiological health. Purchaser acknowledges that his/her products must comply with these regulations before they can be sold to a customer. The output light from this product is harmful to a human body even if it is invisible. Avoid looking at the output of this product directly, or through a lens during operation. Observance of operation should be through a TV camera or related equipment. Refer to IEC 825-1 and 21 CFR 1040.10-1040.11 as a radiation safety standard for laser products.

Oplink follows a policy of continuous product improvement. Specifications are subject to change without prior notice. The module's warranty is 1 year.

R04.20090331