



DESCRIPTION

- 76.00mm (3.0") Single digit numeric display series.
- Standard brightness.
- Low current operation.
- Excellent character appearance.
- Easy mounting on P.C.boards or sockets

Package Dimensions & Internal Circuit Diagram

FYS-30012 Series

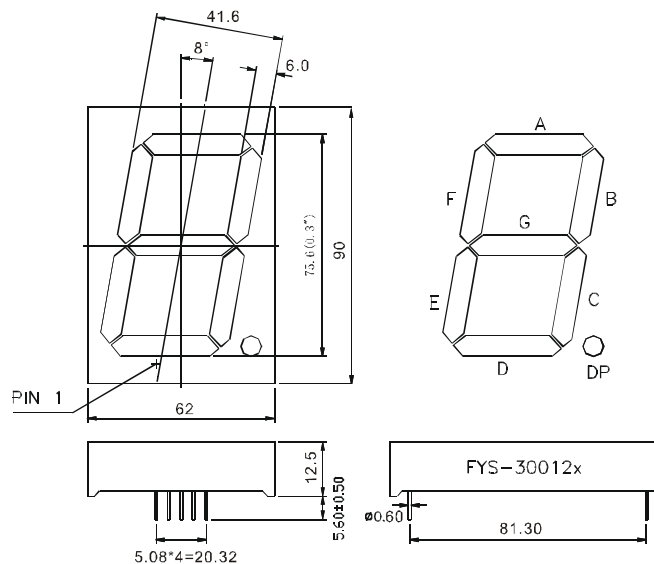

FYS-30012Ax

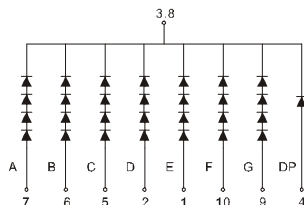

FYS-30012Bx

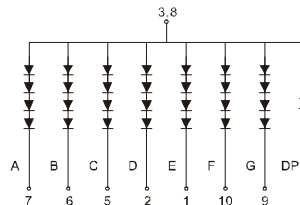

Notes:

- All dimensions are in millimeters (inches)
- Tolerance is $\pm 0.25(0.01)$ unless otherwise noted.
- Specifications are subject to change without notice.



PartNO.: FYS-30012AX/BX-XX

: Absolute maximum ratings (Ta=25°C)

| Parameter | Symbol | Test Condition | Value | | Unit |
|-----------------------|--------|---------------------|-------|-------|------|
| | | | Min | Max | |
| Reverse Voltage | VR | IR=30μA | 5 | ----- | V |
| Forward Current | IF | ----- | ----- | 30 | mA |
| Power Dissipation | Pd | ----- | ----- | 100 | mW |
| Pulse Current | Ipeak | Duty=0.1mS, 1KHz | ----- | 150 | mA |
| Operating Temperature | Topr | ----- | -40 | +85 | ° C |
| Storage Temperature | Tstr | ----- | -40 | +85 | ° C |

■ **Description:**

• Color Code & Chip characteristics: (Test Condition: IF=20mA)

| Emitting Color | | Dice Material | Peak Wave Length (λp) | Spectral Line halfwidth(Δλ1/2) | Forward Voltage(VF) Unit:V | | Luminous Intensity (lv) Unit:ucd |
|----------------|-----------|---------------------|-----------------------|--------------------------------|-------------------------------|------|-------------------------------------|
| | | | | | Typ | Max | |
| H | Red | GaP/GaP | 700nm | 90nm | 2.25 | 2.50 | 500 |
| S | Hi Red | GaAlAs/GaAs,SH | 660nm | 20nm | 1.85 | 2.20 | 3500 |
| D | Super Red | GaAlAs/GaAs,DH | 660nm | 20nm | 1.85 | 2.20 | 6000 |
| UR | Ultra Red | GaAlAs/GaAs,DD H | 660nm | 20nm | 1.85 | 2.20 | 12000 |
| E | Orange | GaAsP/GaP | 635nm | 35nm | 2.10 | 2.50 | 2500 |
| Y | Yellow | GaAsP/GaP | 585nm | 35nm | 2.10 | 2.50 | 2000 |
| G | Green | GaP/GaP | 570nm | 30nm | 2.20 | 2.50 | 2500 |

• -XX: Surface / Lens color:

| Number | 0 | 1 | 2 | 3 | 4 | 5 |
|-------------------|-------------|----------------|--------------|----------------|-----------------|---|
| Ref Surface Color | White | Black | Gray | Red | Green | |
| Epoxy Color | Water clear | White diffused | Red Diffused | Green Diffused | Yellow Diffused | |



PartNO.: FYS-30012AX/BX-XX



- | | |
|---|--------------------------------------|
| (1) - GaAsP/GaAs 655nm/Red | (9) - GaAlAs 880nm |
| (2) - GaP 570nm/Yellow Green | (10) - GaAs/GaAs & GaAlAs/GaAs 940nm |
| (3) - GaAsP/GaP 585nm/Yellow | (A) - GaN/SiC 430nm/Blue |
| (4) - GaAsP/GaP 635nm/Orange & Hi-Eff Red | (B) - InGaN/SiC 470nm/Blue |
| (5) - GaP 700nm/Bright Red | (C) - InGaN/SiC 505nm/Ultra Green |
| (6) - GaAlAs/GaAs 660nm/Super Red | (D) - InGaAl/SiC 525nm/Ultra Green |
| (8) - GaAsP/GaP 610nm/Super Red | |



FORWARD VOLTAGE (Vf)
FORWARD CURRENT VS.
FORWARD VOLTAGE

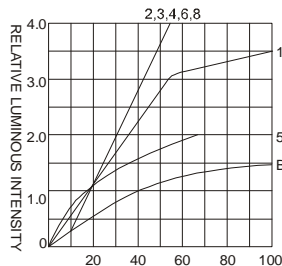

FORWARD CURRENT (mA)
RELATIVE LUMINOUS
INTENSITY VS. FORWARD
CURRENT

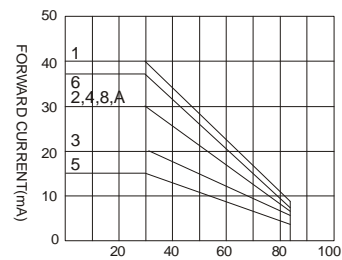

AMBIENT TEMPERATURE Ta(°C)
FORWARD CURRENT VS. AMBIENT
TEMPERATURE

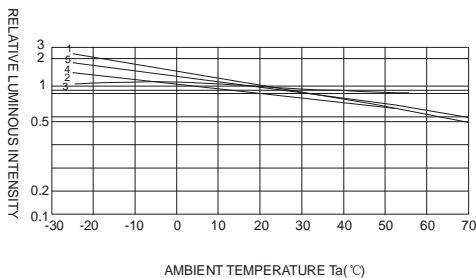

AMBIENT TEMPERATURE Ta(°C)

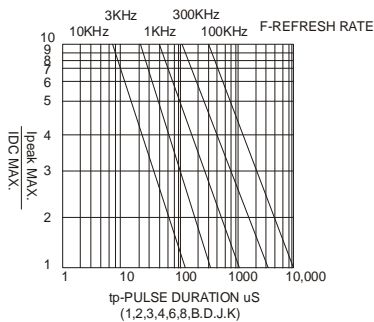

Ipeak
IDC MAX.

tp-PULSE DURATION μS
(1,2,3,4,6,8,B,D,J,K)

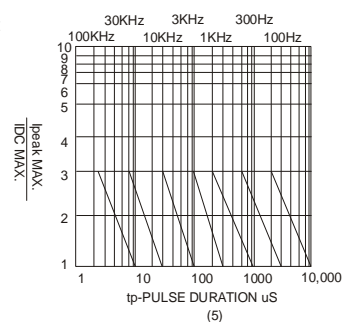

Ipeak
IDC MAX.

(5)

NOTE:25°C free air temperature unless otherwise specified



**NINGBO FORYARD OPTO
ELECTRONICS CO.,LTD.**

LED DIGIT DISPLAY

PartNO.: FYS-30012AX/BX-XX

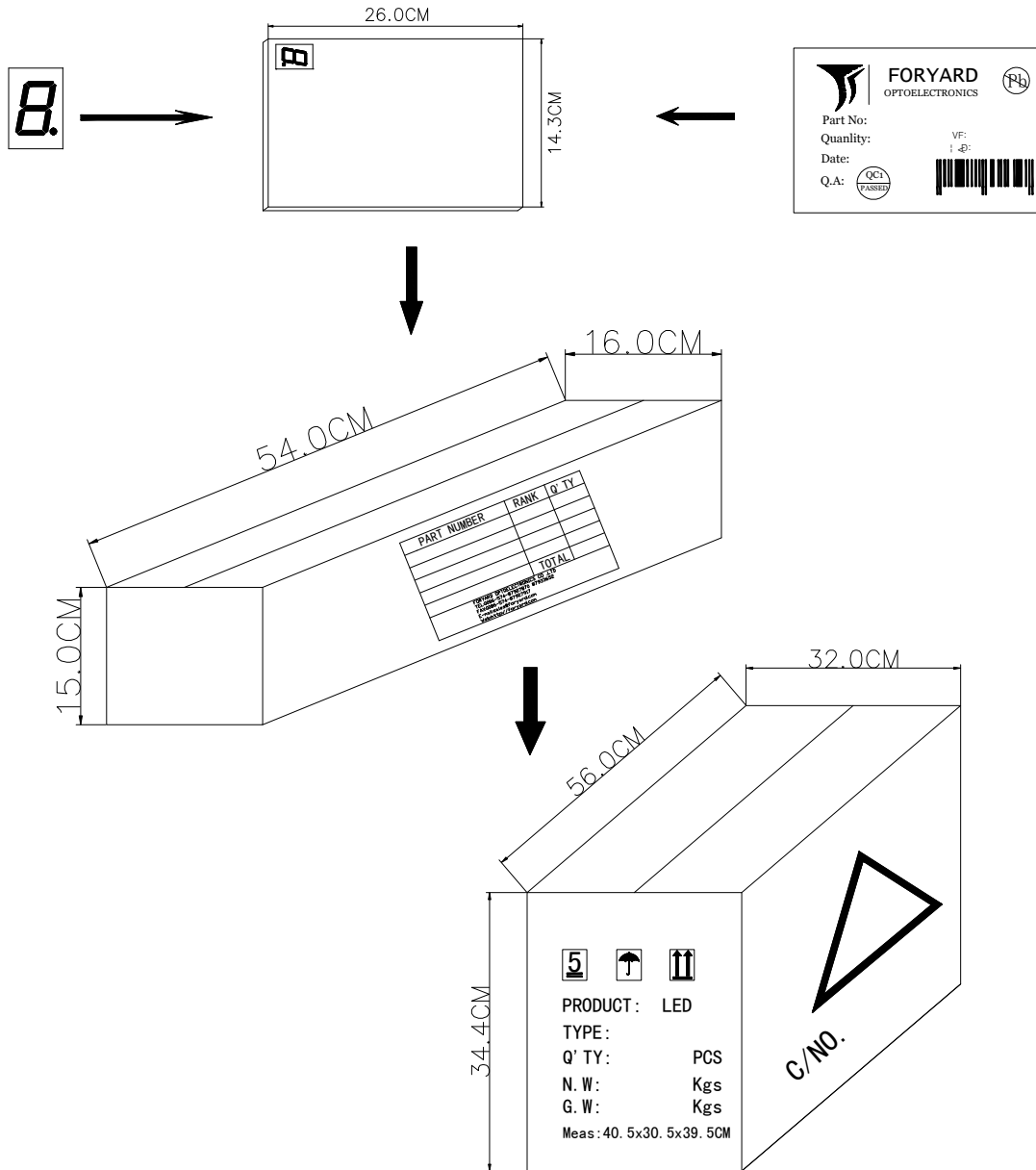

| tapy | QTY/foam(pcs) | QTY /Bundle (pcs) | QTY /CARTONDimension |
|------|---------------|-------------------|----------------------|
| | | | |
| | | | |
| | | | |

ADD: NO.115 QiXin Road NingBo Zhejiang China ZIP: 315051
 TEL: 0086-574-87927870 87933652 FAX:0086-574-87927917
[Http://www.foryard.com](http://www.foryard.com) E-mail:sales@foryard.com